

# AMIGA

## FORMAT

ISSUE 13 ■ AUGUST 1990 ■ £2.95

# THRILL!

To movies, monsters,  
action and adventure from the  
big screen to the Amiga

COVER  
**13**  
DISK

## CADAVER

PLAYABLE DEMO OF  
THE STUNNING NEW  
3-D GAME FROM  
IMAGEWORKS



**NO COVERDISK?**

THEN ASK FOR ONE FROM YOUR NEWSAGENT

# GASP!

at the wonders  
of Pro Draw 2

# GRAPPLE!

with the best in  
programming languages

# SCREAM!

with delight at  
the arrival of AMOS

# SWOON!

in amazement at  
all the new games



# SIGNS OF



SHADOW WARRIORS, the latest, greatest and most ambitious martial arts coin-op game now rages onto your computer

**FEATURING** interactive scenic backdrops. The secrets of the Ninjitsu assassination techniques have been handed down since the Mediaeval wars..now they live on in the jungle of the American metropolis. A thousand years of the Ninjitsu secrets at your fingertips...

Take your techniques to the streets  
**SHADOW WARRIOR...the hero of the nineties.**



# MIC



## IVANHOE

Enter a mediaeval era in a mystical world where Ivanhoe, our chivalrous hero, pursues a perilous quest... a quest from which most mortals would flee! Strap on your armour, take up your sword and brace yourself to face the magical powers of the most evil of wizards, the plunderous pirates, the most awesome of dragons and a host of hideous 'beings' in this land of legends. Superb animation, of cartoon quality and beautifully executed graphics create a visual impact unrivalled in the media of interactive entertainment.

## THE LOST PATROL

WE'RE FIT, WE'RE ALIVE BUT WE'RE NOT BACK HOME. Our chopper tailed-out after taking a hit.... the pilot won't be leaving the ground again. Now I have to lead my weary platoon back to our lines through the jungles and paddy fields. Entering what appears to be a friendly village, only to find it is a cover for a guerilla faction, is just one of the things that helps our insomnia...Jeez, will this stupid war never end!

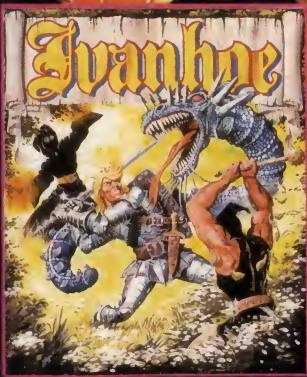

# THE TIMES

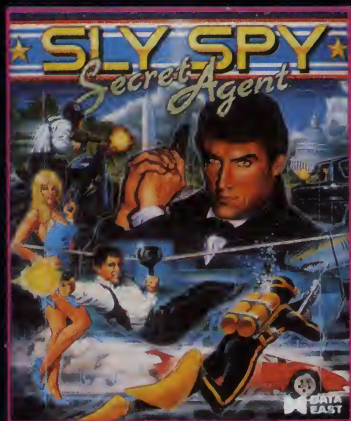

The hit coin-op game bringing espionage and action with 9 levels of thrills and excitement. Innovative game features with a host of differing scenarios from high-powered sports cars to underwater guerilla warfare. Rescue a beleaguered nation from the oppressive regime of the 'Council for World Domination'.

**ESPIONAGE EXTRAVAGANZA  
FEATURING 9 LEVELS OF HIGH ACTION!**



# XO

"Utterly mouth-watering graphics and an amazing depth of play ... the best flight simulation I have ever seen (and there's nothing on the visible horizon that looks set to come close). It's not a simulation, it's an experience ... Ocean's first flight sim is the best out!" Zzap 97%.



6 Central Street · Manchester · M2 5NS  
Telephone: 061 832 6633 · Telex: 669977  
OCEANS G · Fax: 061 834 0650

**ATARI ST  
AMIGA**



### AMOS - AT LAST! 75

Mandarin's Games-Creating Language

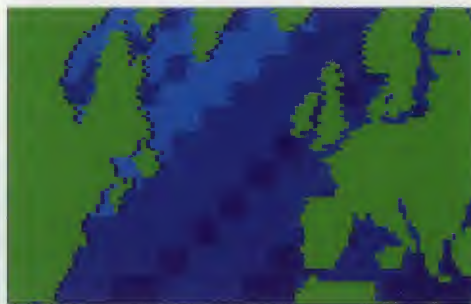

### GRAPHICS 31

Special Effects - Surface Mapping

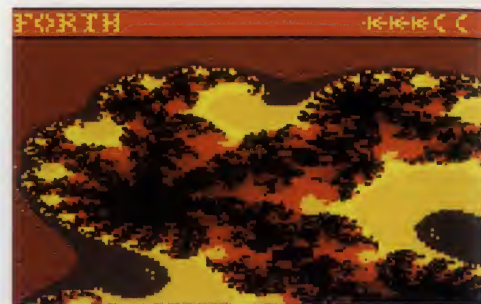

### PROGRAMMING 109

A Complete Round-up of Languages

COVER ILLUSTRATION: ROY ELLSWORTH

# MOVIEDROME p15

Games take much of their inspiration from the movies...and why not, because that is, in a sense, what they're there for - and there you have it...

**AMIGA  
FORMAT**  
**13**  
**JULY  
1990**

**EDITOR** Bob Wade **PRODUCTION EDITOR** Damien Noonan **REVIEWS EDITOR** Andy Smith  
**STAFF WRITER** Maff Evans **ART EDITOR** Marcus 'Dr' Dyson **DESIGN ASSISTANT** Paul Morgan  
**EDITORIAL ASSISTANT** Mark Hill **DISK EDITOR** Richard Monteiro **CONTRIBUTING EDITORS** Jon Bates (Music), Brian Larkman (Graphics) **CONTRIBUTORS** Gordon Houghton, Mark Smiddy, Dave Jones, Tim Smith, Trenton Webb, Pat McDonald, Jason Holborn, Paul Andreas Overaa  
**ADVERTISING MANAGER** Jennie Evans **AD SALES EXECUTIVE** Paul Steer **AD PRODUCTION** Fiona Milne **AD SERVICES** James Leach **PUBLISHER** Greg Ingham **ASSISTANT PUBLISHER** Jane Richardson **LINOTRON** Patrick Leith, Dirk Murlebach, Chris Stocker.  
**PHOTOGRAPHY** Ashton James, Bradford-upon-Avon **COLOUR ORIGINATORS** Swift Graphics Ltd, Southampton, **PRINTERS** Riverside Press Ltd, St Ives PLC, Gillingham **DISTRIBUTORS** SM Distribution, 6 Leigham Court Road, Streatham, London SW16.

**future**  
PUBLISHING

© FUTURE PUBLISHING 1990. Amiga Format comes to you from the company that publishes ST Format, New Computer Express, Amstrad Action, Your Sinclair, S - The SEGA mag, PC Plus, 8000 Plus, MacPublishing, Classic CD

**EDITORIAL/ADVERTISING**  
30 Monmouth Street, Bath, BA1 2AP ☎ 0225 442244 FAX: 0225 446019

**SUBSCRIPTIONS/MAIL ORDER**  
The Old Barn, Somerton, Somerset TA11 7PY ☎ 0458 74011

**COVERDISK HOTLINE**  
☎ 0225 765086 between 2pm and 6pm weekdays only

We welcome written enquiries, but regret that we cannot offer advice, guidance or information on a personal basis, either by telephone or post. We welcome contributions from readers but unfortunately cannot guarantee to return material submitted to us, nor can we enter into personal correspondence. We take great care to ensure what we publish is accurate but we cannot accept liability for any mistakes or misprints. No part of this magazine may be reproduced in any form without our permission.

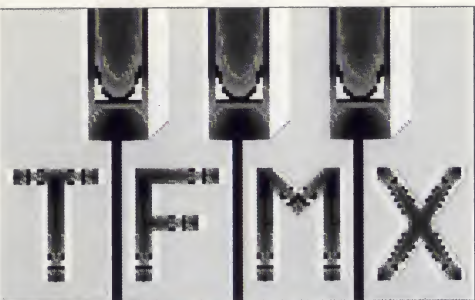

**TFMX 131**

Making Music for Games is Made Easy!



**SCREENPLAY 38**

Kick Off 2 - As good as it should be?

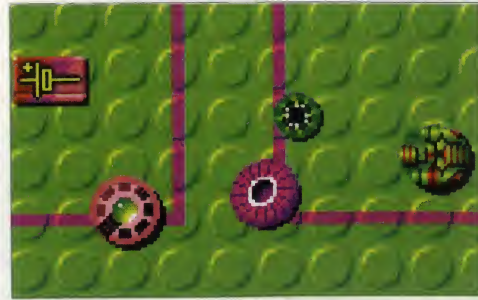

**SCREENPLAY 46**

Projectyle - A whole new ball game



**Contents**

**SPECIALS**

**MOVIEDROME**  
Games and the Movies in cahoots **15**

**MIND YOUR LANGUAGE**  
Programming languages explained **109**

**TRICKS WITH COPPERS**  
Graphics techniques at hardware level **119**

**GAMES PROGRAMMING 7**  
*Menace* Level One is complete at last! **127**

**THE INDEX**  
A year of *Amiga Format*... **135**

**REVIEWS**

**DRAW FOR ALL**  
*Professional Draw 2* from Gold Disk **31**

**GAMES WORKSHOP**  
Mandarin's games language *AMOS* **75**

**PUMP UP THE MUSIC**  
*TFMX* makes marvellous music **105**

**CLOSE TO THE EDIT**  
*Cygnus Ed 2* edits that text! **123**

**NATURAL SCENE**  
*Scene Generator's* Fractal landscapes **125**

**REGULARS**

**NEWS**  
Commodore's CDTV is launched **7**

**COMING ATTRACTIONS**  
All the newest games previewed **12**

**GRAPHICS**  
Special Effects - Surface Mapping **25**

**MUSIC**  
Reviews of *Tiger Cub* and *Copyist Apprentice* **97**

**PD UPDATE**  
What's new in the world of free software **79**

**WORKBENCH**  
A selection of the best hints and tips **145**

**GAMEBUSTERS**  
Tips, maps and guides to busting games **155**

**LETTERS**  
Correspondence on *so many* issues **169**

**GURU**  
The triumphant climax of the magazine **178**

**SCREENPLAY**

**FORMAT GOLD**

**KICK OFF 2** **38**

**PROJECTYLE** **46**

**HERO'S QUEST** **57**

**REVIEWED**

**KLAX** **41**

**DYNASTY WARS** **42**

**3D TENNIS** **45**

**THE PLAGUE** **48**

**IMPERIUM** **50**

**RORKE'S DRIFT** **52**

**TURRICAN** **54**

**TURN IT** **58**

**TIME SOLDIER** **60**

**GRIDRUNNER** **60**

**GHOSTS 'N' GOBLINS** **61**

**MANHUNTER 2** **63**

**DEFENDERS OF THE EARTH** **64**

**CHESSMASTER 2075** **66**

**FIRE AND BRIMSTONE** **68**

**SUBSCRIBE NOW !**

If you read *Amiga Format* every month, why not make sure of your copy by getting it delivered straight to your door? Save hassle, save money and get a free game, too!  
See Page 143 for details!



Member of the Audit Bureau of Circulations  
**40,371** Jul-Dec 1989

**Disk Extra**

**CADAVER**

PLAYABLE DEMO OF BITMAPS' CASTLE CAPERS FROM IMAGEWORKS

**FENSTER:** Amazing screen handling ■ **POPUPMENU:** Makes menus much simpler ■ **ZAP:** Multitasking binary editor

**MENACE**

DAVE JONES COMPLETES HIS SERIES AND HERE'S THE SOURCE CODE

**LHARCA:** Friendly archiving facility ■ **COPPER TUTORIAL:** Graphics tricks to go with the programming feature

**87**

**AMOS - The Creator** is like nothing you've ever seen before on the Amiga. Developed by the author of the best-selling STOS, the number one game creation tool for the Atari ST, AMOS stretches the Amiga to its limits. Now for the very first time you can access the awesome power of your computer with bewildering ease.

AMOS Basic is a sophisticated development language with more than 500 different commands to produce the results you want with the minimum of effort.

Whether you want to create arcade games, adventure games, demos, educational programs – or even serious applications like graphical databases or video titling sequences – AMOS will turn your dreams into reality.

It's no wonder that Amiga Format has described AMOS as 'the most eagerly awaited Amiga utility ever', and Amiga Computing said in its May 1990 four-page preview: "Whoosh! By far the fastest Basic interpreter on the Amiga. Runs like the wind... Nobody will ever top it... Cheap at twice the price... Overall 94%."

Don't delay, send for your copy of AMOS today – and you'll also receive, absolutely free of charge, **AMOS Sprites 600** – a fabulous collection of more than 600 animated sprites for use in your games (not available separately).

We're so convinced about AMOS that we're even offering a money-back guarantee if you're not satisfied.

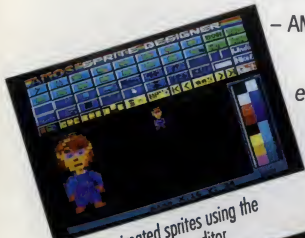

Design animated sprites using the feature-packed sprite editor

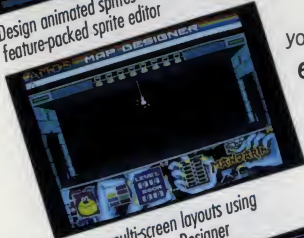

Create multi-screen layouts using the powerful Map Designer



Use the sophisticated program editor to design your creations

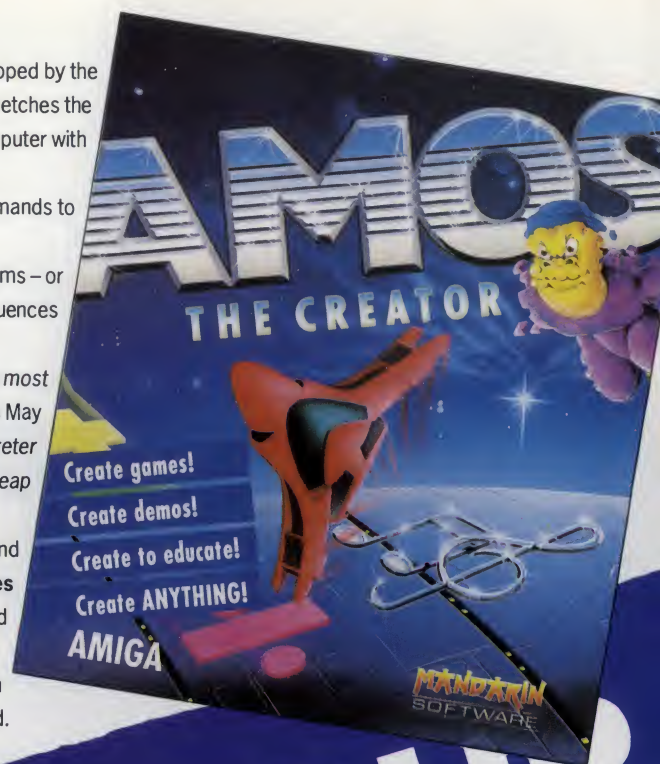

Create games!  
Create demos!  
Create to educate!  
Create ANYTHING!  
**AMIGA**

MANDARIN SOFTWARE

# UNLEASH YOUR IMAGINATION



Play the addictive Magic Forest and see just what AMOS can do!

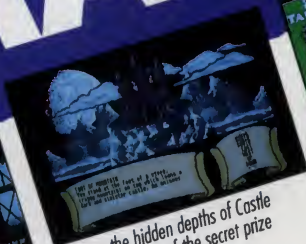

Explore the hidden depths of Castle AMOS in search of the secret prize



Leap across the lilies to learn your times tables the fun way in Number Leap

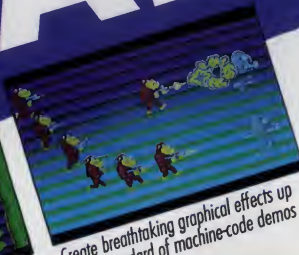

Create breathtaking graphical effects up to the standard of machine-code demos

**ONLY £49.99!**

## WHAT YOU GET:

AMOS Basic, sprite editor, Magic Forest and Amostroids arcade games, Castle Amos graphical adventure, Number Leap educational game, 300-page manual with more than 80 example programs on disc, sample tunes, sprite files, AMOS Club Newsletter and registration card.

## WHAT YOU CAN DO:

- Define and animate hardware and software sprites with lightning speed
- Display up to eight screens on your TV at once – each with its own colour palette and resolution (including HAM, half-brite and dual playfield modes)
- Scroll a screen with ease. Create multi-level parallax scrolling by overlapping different screens – perfect for scrolling shoot-'em-ups
- Use the unique AMOS Animation Language to create complex animation sequences for sprites, bobs or screens which work on interrupt
- Play Soundtracker, Sonix or GMC (Games Music Creator) tunes or IFF samples on interrupt to bring your programs vividly to life
- Use commands like RAINBOW and COPPER MOVE to create fabulous colour bars like the very best demos
- Transfer STOS programs to your Amiga and quickly get them working like the original
- Use AMOS on any Amiga from an A500 with a single drive to the very latest model with hard disc

Please send me **AMOS - The Creator** and my free copy of **AMOS Sprites 600**

I enclose a cheque payable to Mandarin Software for £49.99

Add £2 per program for Europe & Eire (£5 Overseas)

Please debit my Access/Visa/Connect card number:

\_\_\_\_\_

Expiry date:  /

Name \_\_\_\_\_

Address \_\_\_\_\_

\_\_\_\_\_

Postcode \_\_\_\_\_

Send to: Database Direct, FREEPOST, Ellesmere Port, South Wirral L65 3EB. Credit card orders: Tel: 051-357 1275



Commodore present their vision of the future

# WHEN IS AN AMIGA NOT AN AMIGA? WHEN IT'S A CDTV!



It looks like a video recorder or a CD player. It isn't either. If you take it apart, you'll find the circuit boards from an Amiga, but it's not an Amiga. So what is it?



One privileged show visitor gets to use the CDTV first hand.



Is this the home entertainment complex of the future - the CDTV. Commodore are hoping it's a world beater.

Rumours about Commodore's 'CD Amiga' have been flying around for months. Many people thought the machine would be an Amiga 500 linked up to a special CD-ROM drive, giving the machine a massive storage capacity and bringing it to the forefront of interactive technology: others believed that an Amiga-based games console would be given a CD drive, giving it a world-beating lead in interactive games and allowing devastat-

ing use of graphics and sound.

Speculations were ended at the Consumer Electronics Show in Chicago at the beginning of June, when Commodore surprised almost everyone by launching something that didn't look even remotely like a computer. This is the CDTV - 'Commodore Dynamic Total Vision' - a compact, oblong black box, owing more of its design to CD players and VCRs than it does to any computer.

### Amiga Hardware

On the front of the CDTV are the words 'Interactive Graphics Player'. Inside the machine is all the hardware from an Amiga 500, plus a hi-fi quality CD player. The idea of the gadget is that it will connect up to hi-fi music and video systems and can play audio CDs as well as CD-Graphics discs (a format used recently by such artists as Lou Reed and Fleetwood Mac to release music-plus-video

versions of their latest albums).

But more than this, the CDTV will play CD-based games and applications that take full advantage of the massive graphics and stereo sound capacity of the discs and of the machine. This is the world's first 'interactive multimedia player' which, according to Commodore, "represents a revolutionary advance in the development of interactive consumer electronics products and home entertainment".

Above all, it would seem that Commodore don't want anyone to think that this is a computer. It has no keyboard, no mouse and no floppy disk-drive, though all three of these are available as add-ons and can be used either as plug-in units, taking advantage of a full set of Amiga ports on the back of the machine, or as infra-red remote control units. All come with a smart black finish to match the machine.

If you do plug on these peripherals, you basically have an advanced Amiga 500 with CD-ROM drive, a Mbyte of chip RAM, improved video capacity and full MIDI. Good news indeed. But if you don't plug the bits in - and this is the key point - you need never know you were using a computer at all.

No UK price has been set for the CDTV, its peripherals or the disks yet, but expect the main unit to come in at somewhere between

## FESTIVAL OF ANIMATION

The competition is underway to find the best Amiga animation of the year.

The third annual animation competition and exhibition run by the Amiga Centre Scotland as part of the Edinburgh Festival is underway. The competition is open to any Amiga user with an animation to show off, which can be submitted on disk or PAL video tape and should be sent to the Amiga Centre Scotland by 31st July.

This prestigious event shows the Amiga off at its very best, previous years have produced very impressive animations indeed. Last years winner was a superb piece of political satire called "Maggie goes Green" by Mark Wirt which was featured in Amiga

Format issue 4 along with the other winners. This wonderful animation was also the cover star of issue 5.

This isn't just a competition either - all the finalist's entries will be on display at an animation exhibition that runs at the ACS's offices during the Edinburgh Festival, from August 11th to 18th from 11am to 2pm (excluding Sunday).

At the time of writing the list of prizes and judges was not finalised, but should be as impressive as last year. We are certainly supporting it because it is the sort of event that the Amiga, and com-



puters in general, need to raise their profile and give them credibility. The graphics and animation produced on the Amiga can be of tremendous quality and it's a legitimate art form that should get wider recognition and acceptance. Entry forms for the competition are available from: Animation Competition, Amiga Centre Scotland, 4 Hart Street Lane,

Edinburgh EH1 3RN Tel: 031 557 4242 Fax: 031 557 3260. Alternatively turn to the inside back page of this issue (p178, where the guru clings grimly to his pitiful existence) and you will find an entry form with all the information you need to send to ACS. Get those entries rolling in and watch out for our report on the exhibition and the winners.

THE FINAL

# BATTLE



*the legend of the sword continues*

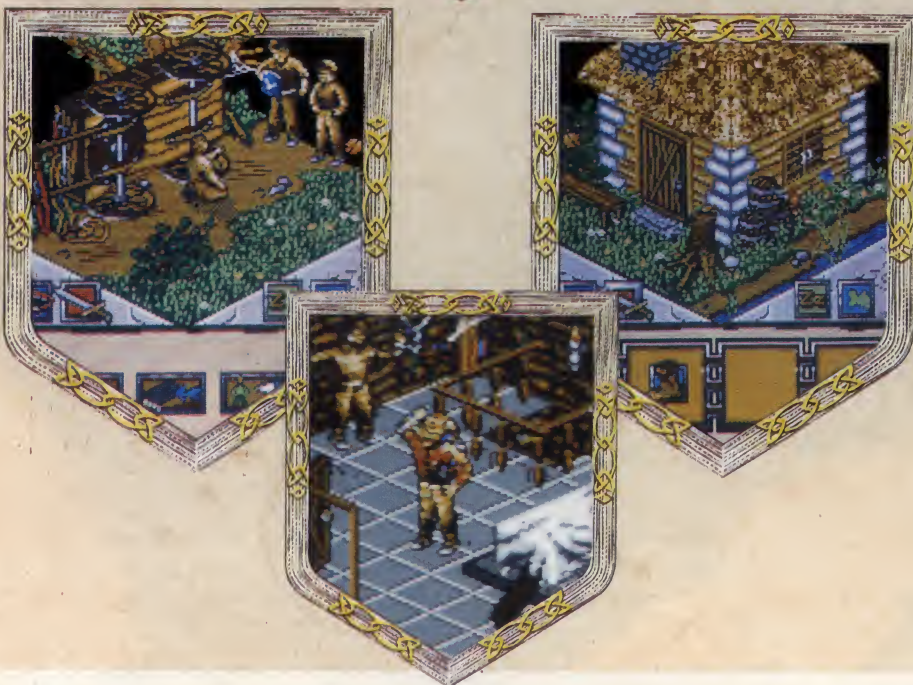

IN THE BEGINNING  
THERE WAS A SWORD,  
THEN CAME THE  
ADVENTURE.



A wizard trapped in a teardrop. A magical sword. A race of mutant humanoids.

Their attempts to destroy the kingdom were thwarted by a band of fearless adventurers. In the chronicles of Anar that chapter became known as the Legend of the Sword.

Then the teardrop shattered and the wizard unleashed a plague of death and destruction upon the land. The world of Anar has one remaining hope: whoever recovers the six power crystals created when the sword was forged, may banish the wizard to the deepest pit of hell...



Final Battle, the sequel to the much-acclaimed Legend of the Sword, features a much larger vocabulary, an expanded inventory and superior graphics. Its highly sophisticated action system allows for weather changes and gives a 3D view of every location – a system at the forefront of contemporary adventuring.

When the teardrop explodes, only the brave can save the land.

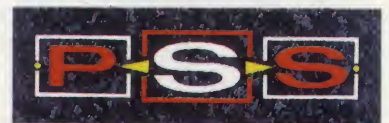





**The complete CDTV set up with its infra-red remote control joystick and mouse. What you are looking at is basically an Amiga with a CD-Rom drive attached. It looks slick in a black box though.**

£750 and £1000. Its launch date is also unknown but it should be around in reasonable numbers well before Christmas.

### What is a CDTV?

The CDTV is operated using an infra-red remote control very much like the one used with a TV or video, which distances it from the computer feel. Its major applications will no doubt prove to be in the mould of 'interactive video', so in many ways it is an advanced video recorder rather than the next step in home computing.

"The system will be used for reference works, special interest areas, surrogate travel, music, entertainment - and once we abandon the high ground it will play one hell of a game!" said Nolan Bushnell of Commodore's Interactive Consumer Products division. The logical conclusions of CD technology in gaming have been contemplated for a while by many companies: Cinemaware are a good example, having spent some time gearing up to produce games that are more like interactive movies. But the other possibilities for interactive educational software and the like are as yet only slightly explored.

Reactions to the new machine have been mixed. Many still thought they'd seen a CD Amiga, others something that could prove to be the future of multimedia and mean the death of the home computer.

At first glance it may not seem so, but peer inside the smart black casing and you might change your mind. The hardware that drives the CDTV is exactly the same stuff you will find inside an

Amiga, complete with the PAD custom chips and a full 1Megabyte of chip RAM. It boots up from a Kickstart 1.3 ROM, it has a 4096-colour palette, a Centronics parallel port, RS-232 serial port, even an Amiga edge connector. To all intents and purposes this is an Amiga. So why not call it one?

For once, you don't have to look behind the surface to find the reasons. This machine does not look like a computer - and that's because it isn't a computer. This is the Commodore Dynamic Total Vision, the world's first multimedia player, and it might just change the face of computing.

**"This will change forever the way we communicate, learn and entertain - all at an affordable price."**

Irving Gould



**"The system will be used for reference works, special interest areas, surrogate travel, music, entertainment - and once we abandon the high ground it will play one hell of a game!"**

Nolan Bushnell

### What happens next?

Reactions to CDTV at CES in Chicago varied between two extremes. Many were still not convinced that this was any more than a CD Amiga. Others were inspired by the prophetic tones of the official Commodore line.

Irving Gould, Commodore's chairman and chief executive officer, said of the CDTV that "this will change forever the way we communicate, learn and entertain - all at an affordable price." The theme of a lifestyle revolution was shared by Nolan Bushnell when referring to Commodore's strides in multimedia, "books were really great in their day - but books right now don't cut it. They're obsolete."

Commodore's bullish attitude is unsurprising because of the immense opportunity and risk that the CDTV represents. If it succeeds, as it deserves to, it will indeed change peoples lives even more dramatically than did the VCR or television.

However, it faces stiff competition from the rival CDI system being developed by several Japanese electronics giants and if it loses the battle in the marketplace it could find the CDTV in a similar position to that of Betamax in the VCR system standard war.

Commodore are clearly aware of the dangers, highlighted by Gould's comment on the licensing of the CDTV system to others, "we've an even money chance of being a de facto standard, so we're under a moral obligation to licence." Which basically indicates that if they can get enough people to put their resources and faith into CDTV, then any rival coming along with a different system will get shut out.

One group already benefitting from the CDTV's launch are 120 Derbyshire schools. They are being supplied with CDTVs by Commodore to teach Japanese. A curious choice until you realise that Derbyshire council have struck a lucrative deal with Toyota to build a car assembly plant there. The systems should be launched there in September, and although initially aimed at teaching Japanese, the possibilities for the CDTV in education are immense and Commodore are clearly keen to pursue them.

As soon as we get our hands on this revolutionary machines we'll review it. Watch this space.

## BRIDGING THE AGE GAP

LCL are expanding their range of educational software to cover all ages. The latest addition, Mega Maths, takes that subject up to A-level and is a companion to Micro Maths which covered it up to GCSE level.

As with all LCL's software Mega Maths consists of 24 programs and 2 books for £24. The new programs include such diverse material as straight line geometry, applications of the remainder theorem, advanced integration and applications of integral calculus – in all there are 105 topics covered.



LCL's new A-level maths software and that must be a student holding it.

LCL is also to release software to cover 3-12 year-olds, called Primary Maths Course. This too will consist of 24 programs and 2 books compatible with the National Curriculum. Its addition means that LCL now have programs to take you all the way through from the age of three to taking A-levels.

As well as the maths courses LCL also do Micro French and Micro English to take the student through from age 8 to GCSE level.

## FILE THOSE FACTS

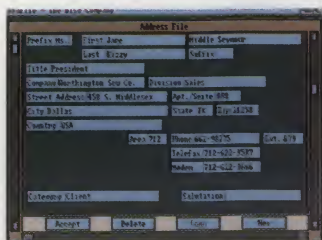

InfoFile, the brand new database from The Disc Company.

Paris based The Disc Company, are releasing a brand new database called InfoFile, at the terribly friendly price of £24.95. The database comes with 10 ready made templates, including an address file, home video library, chequebook records, membership manager and expense report.

Amongst InfoFile's features is a desktop presentation tool that allows the creation of a sound and graphics slide show from a database. It also has the ability to define calculations in a similar way to a spreadsheet. It's compatible with files from FusionPaint, DeluxePaint, DigiPaint, Future Sound and Pro Sound Designer or any IFF compatible graphic or sound program.

The program is available from The Disc Company's UK suppliers – Centresoft, Leisuresoft, Gem, HB Marketing and Multi-Media, or you can phone their Paris office for more info on 010 33 1 49 10 99 95

They too are £24 for 24 programs and 2 books.

For more information on any of LCL's software you can contact them on 0491 579345 or write to them at Thames House, 73 Blandy Rd, Henley-on-Thames, Oxfordshire RG9 1QB.

## UNIVERSAL TRANSLATION

Getting data from one make of computer to another has always been a problem, requiring different comms software, special cables for each machine or lots of painstaking retyping – a very frustrating business. Now Music Suite think they have come up with the answer for Amiga owners, the Printercept.

The idea behind the Printercept is that it makes the Amiga look like a printer to another computer, which then dumps files to it, complete with formatting commands like underline and bold. It will also convert the file for use in various word processing formats like Protext and Scribble. It will even convert picture files to IFF.

The software comes with a cable that connects to the Amiga's parallel port and plugs into the other computer's printer port. The software can also accept serial communications.

Music Suite already have experience of this sort of data transmission through their software for linking the Z88 portable to the Amiga. The Printercept costs £34.95 from the Music Suite on 0239 711032 (credit card hotline available on 0239 710594) or at Glanyrafon House, Cenarth, Newcastle Emlyn, Dyfed SA38 9JN.

## TIMECODE EDITING

If more proof were needed that the Amiga is a heavyweight in video work then check out KRP Video Services new timecode editing system. It consists of 2 modified Panasonic FS 100 S-VHS VCRs, an A500, a Rendale Super 8802 S-VHS genlock and a timecode box with software – impressive, isn't it? So is the price at £5,999 – but that compares very well with similar systems and includes installation and a days training.

Apparently this impressive list of hardware allows you to take previously recorded or new camera footage and timecode it. Decisions about edit in and out points are made on a visibly coded copy, so you can perfect the edit without risking your original tape. If this sound like the sort of gear your video work needs then contact KRP Video Services on 041 762 2510 or at Buchley Lodge, Balmuldy Road, Bishopbriggs, Glasgow G64 3QQ.

The timecode editing system from KRP Video Services



## NUMBER TROUBLE

Anyone trying to contact Tofware International on the fax number they printed on their advertisement in the July issue, won't have had much success because it's incorrect. The number should be 0733 371703.

## AMIGA IN BOOTS

Excellent news for the Amiga from retail chain Boots – they are returning to the computer hardware market in September with the Amiga 500. They already stock software but the Amiga 500 will be the only computer they sell in over 150 Boots Sound and Vision departments. Another indication, if any were needed, that the Amiga is still a very long way ahead of the competition. It's getting to be a case of where can't you buy an Amiga these days?

## SOUNDS ALTERNATIVE

New Dimensions are adding a new dimension to music making with their TechnoSound sampler. It consists of a module that plugs into the printer port, software, manual and an audio tutorial tape. The

software features true quality stereo and simulated stereo (for memory saving) and sampling can be done for any frequency using a music scale indicator. Effects available include echo, hall, room and phaser, and when you get to editing and mixing there's continuous looping on hand.

Initially TechnoSound is only available mail order, so for more information contact New Dimensions on 0291 690933 or at Brooklands House, Bryngwyn, Raglan, Gwent NP5 2AA.

## I KNOW IT, I KNOW IT

Sporting trivia fans should keep their eyes peeled for a couple of triv games on the way from Amfas Computer Software. First up is Everton FC Intelligentsia, a football triv game that isn't just about Everton, but footie in general. It costs £19.99 and the highest cup winning score on the game by 31st December wins £200.

Coming in the Autumn is Ian Botham's Sports Quiz which covers everything from football to tidlywinks in its 1700 question quest for sporting trivia. This too will have a high score competition to win £150 and an autographed cricket bat from Ian Botham himself. Now who was the world tidlywink champion in 1938?

# So You Wanna Be a Hero...

NEW  
RELEASES!

DYNAMIC THRILLERS & ADVENTURES ALL THE WAY!

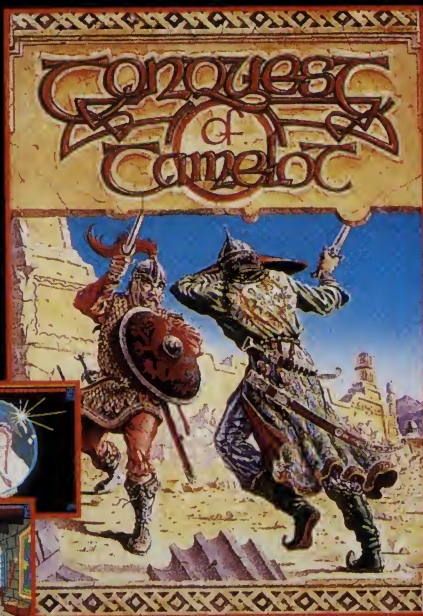
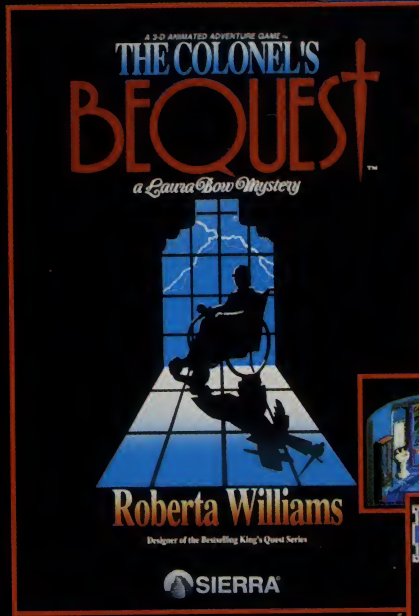
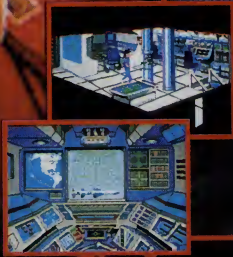

Available for your PC, Atari ST  
& Amiga at all leading  
computer shops or by mail order.



Mail Order: Intermediates Ltd. P.O. Box 847, Harlow CM21 9PH Tel: (0279) 600197



# SIERRA®

Sierra Consumer Hotline: (0734) 310003



**1 Welltris**  
Alexey Pajitov may not be as famous or have as much of a pop star image as, say, the Bitmaps: but he's written one game to rival anything they've produced – the phenomenal *Tetris*. Alexey's been hard at work over the last few months on the sequel, due out shortly from **Infogrames**.

As in *Tetris*, the object is to manipulate shapes and get them to lock together. *Welltris* almost literally adds a new dimension, however, in that the pieces are falling down a well which you view from above. Lines of fitted shapes can now be made vertically and horizontally. Eggheads and frustration players, this is what you've been waiting for.

**2 Murder in Space**  
Amateur detectives out there will soon be able to exercise their skills in this one from **Infogrames**, which sends you to the year 2005 on board an orbiting space station to save the lives of eight crew members.

# COMING ATTRACTIONS

Summer at last, and a heap-and-a-half of new releases storms onto your screens soon!

**3 Metal Masters**  
If you'd rather be at the controls of a skyscraper-sized robot, then there's always **Infogrames'** *Metal Masters*. This is an arcade game where you first have to buy and assemble your 'bot before entering it into either a combat arena or a sports track to take on other robots. This hi-tech mayhem is due around September time, so look out for it.

**4 Final Countdown**  
As a beautiful female spaceship commander (with a propensity for wearing bizarre jumpsuits and only one stocking) it's your job in this

arcade adventure to penetrate the hull of a large spacecraft disguised as an asteroid on a collision course with Earth.

This **Demonware** game has a huge game area and a real *Impossible Mission* feel about it as you troll around the ship hacking into its computers and solving puzzles as you go. *Final Countdown* should be around even as you read this.

**5 Oops Up!**  
**Demonware** have also been beavering away on a wacky mix of platform, puzzle and shoot-em-up called *Oops Up!* The scenario (apparently) has you buzzing round the galaxy trying to

procure parts of a large spaceship. *Oops Up!* promises to be one of those very simple but very addictive games. You'll be able to find out very soon.

**6 Hagar the Horrible**  
Coming from **Kingsoft** through the very same publishers is the conversion (from the cartoons) of that loveable rogue Hagar the Horrible. Details of the game are sketchy at the moment, but it's believed the game will be some sort of humorous arcade adventure. More details as soon as they come in, but in the meantime here's a picture to keep you going.

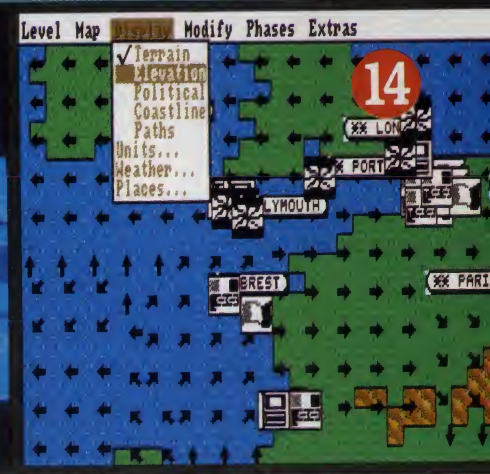
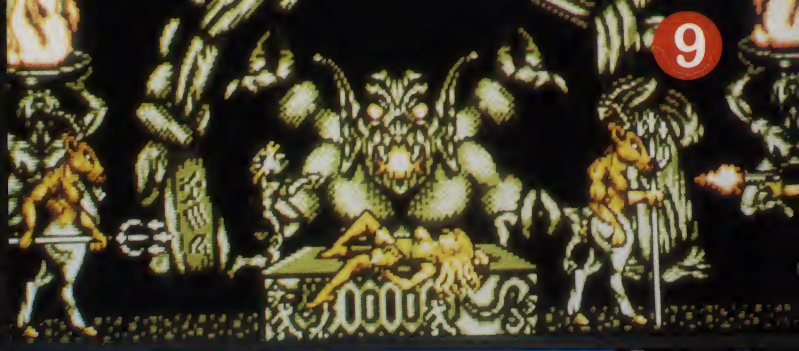

**7 Time Machine**  
The team behind the great game *Hammerfist*, Vivid Image, have been working on another game to come out on the **Activision** label. *Time Machine* is billed as a 4D fantasy role-playing arcade adventure. There are puzzles to solve as the player takes on the persona of Prof Potts, who must manipulate history and create the future by interfering with evolution. August should see the release of this 'deeper than your average' game.

**8 Yolanda Millennium** will shortly be following up the superb *Resolution 101* with a new Steve Bak game. It's a platform game, with the player becoming the daughter of Hercules and having to undergo the famous Twelve Tasks in order to lift a curse from her father. This is a re-working of a C64 game (imaginatively called *Hercules*) and features some 50 levels with a special beginners' training level.

**9 The Gold Of The Aztecs**  
That's the prize for any brave adventurer who can work his way through 80 screens of puzzles and traps which will test not only your mind, but your joystick reactions as well. There promises to be a surprise round every corner in the jungle world of this latest **US Gold** game!

**10 Snow Strike**  
For those who fancy their fun a bit further off the ground, **US Gold** are also gearing up to release a combat flight sim called *Snow Strike*. In the game you'll be flying specially converted F14s on 10 top-secret missions to destroy drug barons.

**11 The Spy Who Loved Me**  
Bond makes another appearance on the small screen in an escapade based on one of his earlier films. The game is due in September and promises to be an action-packed thriller which follows the plot of the film closely. As Bond your mission will

be to liaise with the beautiful Soviet agent Anya Amasova... pay attention, 007!... and put a stop to the evil genius Stromberg who's captured a couple of nuclear submarines and is threatening to take over the world.

**12 Neuromancer**  
**Electronic Arts** have decided it's high time us Amiga-owning Science Fiction fans should have *Neuromancer* to play with. The game's a role-playing affair based on the best-selling book by William Gibson, king of Cyberpunk (*Cyberpunk n. adj. genre of writing involving humans at conflict with a decaying high-technology society*). The game's set in 21st Century Japan and the player plays the part of a hacker out to survive on the tough streets of the future world.

**13 Magic Fly**  
Also set in the future is **Electronic Arts'** *Magic Fly*, a vast search and destroy game which sees the player pilot-

ing the ultimate confined-space fighter in a bid to bring a bunch of future crims to their knees. Get ready for plenty of blasting action as you battle against over 30 different alien craft all beautifully rendered in yer 3D solid vector graphics (whatever they are...)

**14 UMS II**  
After much umming and aahing it seems the follow-up to one of the best 16-bit wargames ever to appear is almost ready to be unleashed on a world of megalomaniacs.

*UMS II* is a global strategic warfare simulator (as opposed to the tactical simulator *UMS*). The player will have armies from all time periods to fight with, across the whole world - a world the player can design, alter and play about with as much as is wanted.

*UMS II* will feature so many options and choices we simply don't have the space to even start to go into them, so watch for the definitive review in next month's action-packed *Amiga Format*.

SCHWARZENEGGER • BOND • BARBARIAN • SKYWALKER

# HEROES

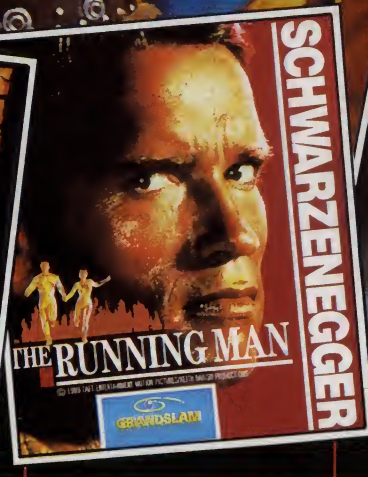

## 4 LEGENDARY HEROES • 1 BLOCKBUSTING COMPILATION

**LICENCE TO KILL**  
Bond is back to take revenge on Sanchez, the evil, double dealing drugs baron. Can you beat the odds and deliver the goods?  
"... excellent graphics and sound make this by far the best Bond game to date... a brilliant game in its own right." Computer & Video Games



**BARBARIAN II**  
Hack 'n slay action. Grisly traps and hideous monsters await in the Dungeons of Drax. The most successful hero ever created for home computers.  
"By far the best (and goriest) beat 'em up..." Zap! 64



**THE RUNNING MAN**  
It's Showtime! Face death in the most dangerous game show of all time!  
"... a perfect computer game... Stirling stuff!" Your Sinclair



**STAR WARS**  
Join the ultimate Sci-fi hero Luke Skywalker in a death-defying last ditch attempt to blow up Darth Vader's stronghold, the Deathstar.  
"Classic film, classic coin-op, classic game" Computer & Video Games



Amiga & Atari ST Screenshots



The Running Man: © 1989 Taft Entertainment Motion Pictures/Keith Barish Productions.  
© 1989 Grandslam Entertainments Ltd.  
Barbarian II: © Palace Software 1988  
Star Wars: ® & © 1987 Lucasfilm Ltd & Atari Games  
Licence to Kill: Distributed by MGM/UA Distribution Co.  
Gun Logo Symbol © 1962 Danjaq, S.A. and United Artists Company. All Rights Reserved.

Published by  
Domark Ltd, Ferry House, 51-57 Lacy Road,  
London SW15 1PR Tel: 081-780 2224

Available on: Atari ST,  
Amiga, Commodore 64  
(cassette, disk) Amstrad  
(cassette, disk)  
Spectrum +3,  
Spectrum 48/128



# Moviedrome

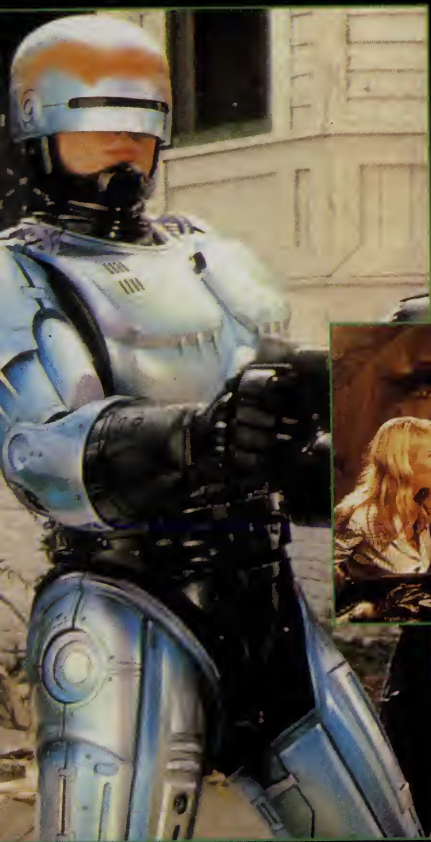

Films and television have long exerted an influence on computer games. **GORDON HOUGHTON** attempts to divine the reasons...

If you thought that the cinema was the only place you could rustle up enough blood to satisfy Dracula, or that TV was the natural home of quiz and puzzle games, then think again! The chances are that the classics of the silver screen and the inimitable gems spawned by television have already influenced games on your Amiga.

There's a constant, unacknowledged flow of information and ideas that filters down from the cinema to

“Implant a subconscious set of film references into a game and it gains a mystical quality which gives it the edge”

the programmer; whether it's the visual impact of an individual scene or the basis for a whole game scenario. It's a source of inspiration that never runs dry – games borrow concepts and images from the same films time and time again.

Science fiction and fantasy tales are natural targets because of the computer industry's emphasis on a synthetic world – whether it's set in an escapist 'alternative' present (like simulators), an invented past (like

many arcade adventures), a mythical environment (like most role-playing games) or a distant galaxy (like most shoot-em-ups).

If a world is synthetic and original, it has no common background to which people can refer, and so the audience isn't likely to respond as well as it would to something it shares. So implant a subconscious set of film references into a game and it gains a mystical quality which gives it the edge over its opponents.



### Stealing the Scene

Some programmers make direct and 'honest' conversions containing snippets of the original film plots and a sprinkling of licensed character names, their work benefitting from the association – *Star Wars* would be a pretty mediocre vector graphics shoot-em-up without the aura of the film behind it. Most games, however, rely on a shared set of experiences with the public to give them a kick in the right direction.

From shoot-em-ups to adventure games, there's a high chance you'll find a sneaky film influence lurking in there somewhere. It could be a Gigeresque visual display, a sampled sound effect, or a familiar storyline. It could be one character who you might recognise from a cartoon or an episode of *Star Trek*, or a name drawn from some obscure 50s B-movie. Whatever source it dribbles from, programmers lap up inspiration without a second thought.

The obvious case is the direct licence, where a software publisher buys the rights to convert film scenes into computer action sequences. Whether it's fleeing from a rolling boulder, biffing drug barons on the tops of oil tankers or busting ghosts that happen to step out of line, computer games grab the vital scenes and try to recreate them as an interactive experience.

Sometimes this leads to disaster: direct film influences used to be dead certs for 'Turkey of the Year' awards, and even now the odd gobbler shuffles its three-toed way onto our monitors. Nowadays, though, games licensed from cinema extravaganzas are just as likely to be a triumph – look at the success of *RoboCop*.

### The Real Thing

If you've bought a licence, you're allowed to cross-translate its thematic ideas and visual images unashamedly – as a result these ideas and images tend to centre on extremes of violence or conflict. Trying to emulate long philosophical discussions is a good tonic for insomniacs.

Last year, in particular, saw the transformation of dramatic scenes from box office blockbusters (*Licence to Kill*, *Batman*, *Ghostbusters 2* and *Indy III*) into eponymous games. And what did they all have in common? Action directly taken from the film.

*Licence to Kill* featured some macho oil tanker sequence, *Batman* emulated its inspiration's dramatic car chase scenes, *Ghostbusters 2*

featured the 'busters putting the willies up spooks inside the Art Gallery, and the *Indy III* Adventure game followed the film's plot almost to the letter.

Making money from games based on cinema licences often involves a crisis of confidence, since the processes of developing a game and finishing off the film are becoming more and more coincidental. Game production walks hand-in-hand with the making of the film – but if one of the hands in question is covered in something runny and smelly, no one benefits.

### More Subtlety

Direct film conversions form only a small slice of the influence pie: programmers get their teeth round subtler forms of inspiration. Films often have an indirect and unaccountable influence – it's a way of getting some of the effect of a big name licence without forking out the moolah.

Anyone who's played *Rick Dangerous*, while realising that it capitalises on the atmosphere of forties screen and serial heroes, also recognises that the rolling boulder at the start of the game bears strong similarities to *Indy I*'s rolling stone. *Tusker* treads a similarly sticky path – his cool bush outfit, nifty hat and daredevil escapades in uncharted territories would make him a fair bet in an *Indy* lookalike competition. No one minds, since imitation really is the sincerest form of flattery.

And what about storylines? Games programmers stuck for a plot have often plundered popular media for 'inspiration'. Shoot-em-ups eagerly guzzle and regurgitate 50s 'Them and Us' sci-fi scenarios. How many times have you read a tale which runs something like 'the five-headed Splarg monster from the planet Xiuuuhrr is threatening sensible life as we know it. Only you (on your own as usual) have the adequately inflated gonads and correctly proportioned joystick to save civilisation.'

Probably one reason why no one's bothered with a licence of the *War of the Worlds* is that the Martian invaders died out of their own accord – it wouldn't make much of a game if all you had to do was sit back and watch as some invisible bacteria did all the dirty work.

### Xenophobia

The fear of invasion or the promise of rebellion dominates blasters as much as it infiltrates SF plots from *Flash Gordon* to *The Return of the Jedi*. This kind of thematic influence is the next stage down from a direct licence: it often can't be quantified because you can't draw an accurate line between a game which follows a trend or one which transposes a plot. Even so, you know that shoot-em-ups

The name's Bond. James Bond. He may be shaken by some of his encounters with SMERSH and he is occasionally stirred by even closer encounters with long-legged women, but he never seems to lose his cool when it comes to the computer screen. The latest Bond movie to hit the Amiga is the somewhat dated *The Spy Who Loved Me*.



"The five-headed Splarg monster from the planet Xiuuuhrr is threatening sensible life as we know it. Only you, on your own as usual, have the adequately inflated gonads and correctly proportioned joystick to save civilisation"

have smart bombs, and you know that the *Death Blossom* in *The Last Starfighter* is a smart bomb, too.

When the parallel is obvious, the games tend to benefit from the comparison. Having the *Tron* light cycles sequence in the back of your mind when playing Pandora's *Tron 5000* doesn't do the latter any harm.

In fact, Pandora seem to occasionally indulge in paying unidentified homage to screen classics: their *Eagle's Nest* evokes images of Clint Eastwood complete with designer three-day stubble biffing Nazis in *Where Eagles Dare*.

But does anyone really care? It's a lot better having your enjoyment of a game increased by its association to other media than being poked in the eye with a pointed stick. *Interphase* and *Neuromancer* would both be good games without their respective 'cyberpunk' influences – but they might never have come about without it, and they certainly wouldn't have the same impact.



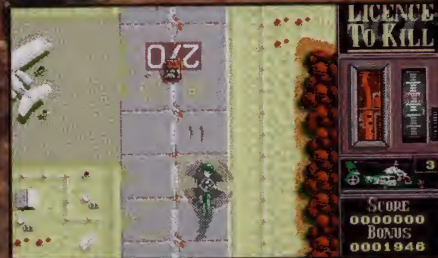

### Graphic Experience

Visual influence is often the most striking area of casual imitation, particularly when the game is being subtly compared to a cult movie. Look at *Speedball's* introductory screen, featuring a player tapping a metallic glove against his thigh – it directly echoes a similar scene in *Rollerball*. This means that the whole context of *Rollerball*, with its strong emphasis on violence, skill and lack of rules, is quietly transferred to *Speedball*, arguably giving it more impact as a game than it would have had if it was truly original.

Other games mirror cinematic images in this way. *Accolade's Gunboat* steaming up a Vietnam river resembles a similar scene in *Apocalypse Now*; the skeletons in *Myth* owe a good deal to the famous animator Ray Harryhausen and *Jason and the Argonauts*; *Weird Dreams'* surreal sense of humour and crazy animation could come straight from a *Tom and Jerry* cartoon.

With some games the link isn't so obvious. Take *The Sentinel*, for example: a mysterious entity, conqueror of 10,000 worlds, monolithic – you could easily draw parallels between that and the monolith in *2001: A Space Odyssey*. The link is particularly strong when you realise that the film itself was based on a book by Arthur C. Clarke called – you guessed it – *The Sentinel*.

### Musical Link

Cinematic scores are different, in that they don't often leap the barrier into Game City. This makes computer music mostly unique – wibbling ditties to match cute games, powerful scores for serious space epics – but even here you can find the mark of the movies. When you're docked in the space station at the beginning of *Elite*, for example, you can hear the faint strains of *The Blue Danube*. The most famous cinematic example using the same score was *2001* (again), in the context of a spacecraft

“Computer music is mostly unique – wibbling ditties to match cute games, powerful scores for serious space epics”

approaching a space station. Sound effects are similarly little copied, but they're fast catching up. Some games rely almost entirely on their special effects, whether they are visual or aural – and there's no better way of subconsciously evoking a positive response than by utilising already established ideas.

As John Hurt explored the pod chamber in *Alien* the action was shown from a first-person viewpoint from within his helmet, the sound effects consisting almost entirely of a kind of hollow, metallic breathing. The brilliant sound effects in *Infestation* echo this: the most striking impressions come in the moments when your helmet is down – a first-person viewpoint accompanied by a hollow, metallic breathing.

### Alien Invasion

*Alien* is one of the most successful science fiction movies of all time, and one of the most highly prized sources for programmers. The crew of a

# ATARI ST and AMIGA

## Sixteen Bit Superdeals from the Sixteen Bit Specialists!

**CUSTOMERS PLEASE NOTE! When comparing prices remember ours include fast delivery by courier.**

**NEW!** **520STE Power Pack** **£349.00** **NOW INC HYPERPACK**  
*Inc. VAT and Next Day Delivery*

**Power Pack includes:**

- ★ 520STE 512K Keyboard with Built-in 1 Megabyte disk drive and TV Modulator
- ★ Over £550 worth of games software, including OutRun, Gauntlet 2, R-Type, Space Harrier, Super HangOn and 16 more Top Games
- ★ Organiser Business Software including WORDPROCESSOR, SPREADSHEET and DATABASE
- ★ First BASIC and First Music Utility Software
- ★ FREE JOYSTICK AND FREE MOUSE MAT WORTH £4.95
- ★ All leads, manuals PLUS MOUSE and free mains plug!
- ★ Hyper Pack S/W inc Hyper Draw, Hyper Paint and Borodino Battlescape War Game worth over £70.00

**520STFM DISCOVERY PACK** **£279.00** **NEW**

**NEW! fantastic value for money pack includes:**

- ★ 520 STE 512K memory keyboard with built in 1 megabyte double sided disk drive and TV modulator
- ★ Game Pack including OTRUN, SPACE HARRIER, CARRIER COMMAND and BOMB JACK
- ★ UTILITY PROGRAMMES inc STOS GAME CREATOR, NEOCHROME painting package and FIRST BASIC programming language
- ★ ST tutorial programme and 'DISCOVER YOUR ST' beginners guide to the ST computer
- ★ PLUS MOUSE, MOUSE MAT, MANUALS, ALL LEADS, METACOMCO BASIC AND MAINS PLUG!

**1040STE BUSINESS PACK** **£449.00**

- ★ Includes the new 1 megabyte 1040STE keyboard plus over £200 worth of business software including WORD UP wordprocessing software, featuring glossary and mail merge, K-Spread 3.0 spread sheet and SUPERBASE PERSONAL Database software Also includes Metacomco BASIC, Mouse Pad, all Leads, Manuals and Mouse.

**MEGA 1 BUSINESS Pack** **£529.00**

**Features:**

- ★ Separate Keyboard and System Unit
- ★ Inc. all software supplied with 1040 STE Business Pack
- ★ Blitter chip installed for faster graphics

*Inc SM124 Mono Monitor.....£628.00*

**ACCESSORIES**

Quickshot II Turbo Joystick .....£9.95	Branded Memorex 3.5" DSDD Disks
Competition Pro 5000 Joystick .....£13.95	Box of 10 .....£13.95
Competition Pro with Autofire .....£14.95	Memorex Disk Box
Konix Speedking Joystick.....£11.95	For 40 3.5" Disks .....£8.95
Red Mouse Mat with Amiga logo ....£5.95	Amiga 1/2 Meg Expansion.....£99.95
Plain blue Mouse Mat .....£4.95	Control Centre Atari or Amiga .£44.95
Naksha Mouse for ST, Amiga or PC.....£29.95	
Contriver Amiga and ST Mouse with FREE Holder and Mouse Pad £20.95	

**PRINTERS**

Star LC10 including interface lead for ST/Amiga.....	£169.00
Star LC10 colour including interface lead for ST/Amiga.....	£219.00
Star LC24-10 24 pin including lead for ST/Amiga .....	£249.00
Citizen 120D + NLQ including interface lead for ST/Amiga.....	£139.00
Citizen Swift 24 pin letter quality including lead for ST/Amiga.....	£309.00
Colour Version of Swift 24 pin .....	£349.00

**AMIGA A500 GAMES PACK** **£399.00** **NEW!**  
*Inc. VAT and Next Day Delivery*

**featuring BAT PACK or the new FLIGHT OF FANTASY PACK**

**BAT Games Pack includes:**

- ★ Amiga A500 512K Keyboard with Built-in 1 Megabyte disk drive.
- ★ Free TV modulator worth £24.99 allowing you to use the Amiga with a normal TV.
- ★ DELUXE PAINT II GRAPHICS PACKAGE.
- ★ FREE HOLIDAY 14 days accommodation
- ★ FREE, only-just-released BATMAN - THE MOVIE games software.
- ★ NEW ZEALAND STORY arcade games software.
- ★ F18-INTERCEPTOR - amazing 3D flight simulator software.
- ★ A further £230 worth of Games Software, including BUGGY BOY, MERCENARY, BARBARIAN, WIZBALL & six more games.
- ★ FREE JOYSTICK, MOUSE MAT AND 10 BLANK DISKS.
- ★ Amiga BASIC, Amiga EXTRAS 1.3, Workbench 1.3 PLUS the Amiga Step by Step Tutorial.
- ★ All leads, manuals PLUS MOUSE and mains plug!

**FLIGHT OF FANTASY Pack Includes:**

- ★ F29 RETALIATOR - fantastic NEW flight simulator - replaces Batman
- ★ RAINBOW ISLANDS - smashing new arcade game - replaces New Zealand Story
- ★ ESCAPE FROM THE PLANET OF THE ROBOT MONSTERS - replaces F18
- ★ Everything else listed for BAT Games Pack.

**AMIGA 1 MEG BAT GAME PACK** **£499.00** **NEW!**

**1 Meg Bat Games Pack includes:**

- ★ Fitted 1 Megabyte Memory Expansion + Real Time Clock Card
- ★ Everything listed for the A500 Bat Game Pack
- ★ DRAGON'S LAIR 1 MEG MEGAGAME!

**AMIGA A500 CLASS OF THE 1990'S BUSINESS + EDUCATIONAL PACK** **£549.00**

**FEATURES:**

- ★ Amiga A500 + TV Modulator
- ★ Midi Interface + Software
- ★ Kind Words II word processor
- ★ Page Setter DTP
- ★ Super Base Personal Database
- ★ Maxiplan 500 Spreadsheet
- ★ Amiga Logo, BBC Emulator, Deluxe Paint II
- ★ Mouse mat, 10 blank disks and disk wallet

**EXTERNAL DISK DRIVES**

Cumana 1 Megabyte Atari or Amiga .....	£89.95
NEC 1 Megabyte Atari or Amiga .....	£79.95
Atari SF314 1 Megabyte.....	£139.00
Amiga A1010 1 Megabyte .....	£99.95
Atari Megafile 30 Hard Disk.....	£439.00
New! Commodore A590 20 meg hard disk.....	£369.00
A590 Hard Disk + Memory Upgrade installed .....	Phone

**MONITORS**

Commodore Amiga A1084 stereo Monitor inc lead .....	£259.00
Atari SC1224 Colour Monitor inc lead.....	£259.00
Atari SM124 Mono Monitor including lead.....	£119.00
Philips CM8833 stereo colour monitor inc. lead for ST or Amiga .....	£249.00

**24 HOUR CREDIT CARD HOTLINE ☎ 0908 378008**

To order either call the orderline above with your Credit Card details OR make a cheque or P.O. payable to: Digicom Computer Services Ltd and send it with your order to the address below. Showroom open at the address below Mon-Sat 10.00am - 6.00pm.

**DIGICOM**

**Unit 36, Wharfside, Fenny Stratford, MILTON KEYNES, MK2 2AZ.**

*All prices include VAT and delivery by courier*

Licensed Credit Brokers \* Written quotations available on request APR 34.5% Variable.



commercial spaceship is brought out of cryogenic freezing to investigate an unidentified signal on an unknown planet in a distant star system.

Before you can say Nostromo, they've unleashed an alien which likes nothing better than guzzling its way through any carbon-based life form, occasionally secreting deadly acid all over the place. As it mutates it becomes stronger, pursuing its quarry with increasing intelligence and strength until only one character (Ripley) survives by fleeing in an escape shuttle.

Most of the games which have snatched snippets from *Alien* have done so visually. The eggs in *Infestation* bear more than a passing resemblance to *Alien's* pods; and the between-level vector graphics routine in *Dan Dare III* has overtones of the film's own landing sequence.

Add to this a whole collection of Giger-influenced graphics knocking about in games such as *Project Firestart*, *Purple Saturn Day* and *Captain Blood*, and you have a film which has done the inspiration rounds more than any other. With an *Aliens* coin-op just released, isn't it about time someone did a direct conversion to 16-bit computers?

### To B Or Not To B

B-movies are part of a tradition stretching back to the '30s and '40s: Hollywood churned out thousands of quick and cheap supports to the main feature – most of them knockabout westerns. In the age of the Atom Bomb and a new scientific awareness, science fiction and the concept of progress out of control was a natural successor – and it's this era that provides the most rewarding stream of inspiration tapped by many contemporary games designers.

Lucasfilm's *Maniac Mansion* and *Zak McKracken* owe a lot to 50s ham acting and tongue-in-cheek horror schlock movies; *Lurking Horror* epitomised the perfect high school melodrama; and what's *Space Quest* but a classic swashbuckler movie dressed in futuristic clothes?

Cinemaware seem to be making a habit of resurrecting B-movie and serial themes, images and sounds: *It Came From The Desert* (loosely based around the black-and-white creature feature, *Them!*) is just the latest in a long list which also incorporates *Rocket Ranger* (loosely associated with *King of the Rocket Men*), and *Sinbad*.

The number of cheap movie themes which would make silly game designs is practically endless: could the next game on Cinemaware's list be a faithful recreation of *Night of The Lepus*, a film which highlighted the perils of mutant rabbits terrorising innocent farmers? Let's hope so. No-one in these ecologically sensitive

times has much bothered with killer animals, despite their popularity in cinematic history – which is probably why no one even thinks about converting tacky classics like *Swarm* (allowing you to play Michael Caine as he gains revenge on those killer bees) or *The Birds* (allowing you to play one of the killer birds as it gets its own back on Tippi Hedren).

### Horror Scope

Horror films are currently undergoing a long-anticipated revival, having completed the transition from the mild Victorian-style ghost stories of the '50s and '60s into the modern day domain of personal body space plots and utterly convincing special effects.

Today's modern shock movie examines intimate issues – John Carpenter studies bodily invasion in *The Thing*, David Cronenberg addresses some pretty repulsive skin problems in *The Fly*. Horror software is a bit more conservative and tends to shy away from the new-fangled modernist approach: it prefers to nestle quietly somewhere between mythical fantasy and tame, old-style themes of vampires, evil robots and mysterious castles.

Take a look at *Ghosts and Goblins* or its successor, *Ghouls 'n' Ghosts*; lots of big enemies and weird landscapes but not much scare factor. *Space Invaders* was about as frightening and exciting as a season ticket to Rochdale United. *Shadow of the Beast* looked wonderful but didn't have anyone changing their trousers.

However, some games have managed to capture small-screen drama in a similar way to their big-screen counterparts: take *Dungeon Master*, for example. If you've been woken up by a gang of screaming mummies or you stumbled upon the dragon for the first time, you know what it feels like to have to peel yourself off the ceiling. It worked so well partly because the graphics (you could never see more than two blocks ahead) and the sound effects (minimal but very effective) combined to create a very tense atmosphere. *FTL* didn't go in for sonic and visual overkill – they knew how to make use of silence and suspense.

The future of horror software looks bright – it's a largely unexploited area with real potential for a new style of game. As it is, there are plenty of good cheap thrills being promised – two games to watch out for in particular are *Elvira*, (if it ever appears, because rumours abound that Tynesoft are no more) and Ocean's *Nightbreed*, a game with a higher mutation factor than a life-time at Sellafield.

### Small Screen Heroes

Alternative are currently mopping up just about every kids' TV licence



**Speedball, Above, gains much of its fearsome atmosphere by a close association with the hard-hitting Rollerball film, Right.**

**Enter the Dragon. Bruce Lee (Below) was the real originator of martial arts popularity in the west and his influence has lingered in games like Budokan.**

**The man with the hat (Bottom) has stamped his mark on some of the closest conversions ever. Is he now past it?**



Photos: Kobal





going on 8-bit (although *Grandslam* got their paws on *Thunderbirds*), but television as a whole has a much more indirect influence on games, particularly cult series. The hairy carpets that pass for rock monsters in Episode 26 of *Star Trek* look suspiciously like the rock monsters in *Dungeon Master*, and there's an obvious link between *Impossible Mission* and *Mission Impossible*.

At least computers are getting their own back on TV: the latest compulsive Saturday night viewing is *Steal*, which features simplistic arcade-style games and is most worth watching to see how people react to that most mysterious of tools, the joystick.

Television stars may be already well established in games (David Coleman and Emyln Hughes to name but two), but there's still a long way to go. No one's captured the quick wit and charisma of Roy Walker in code, nor has anyone realised the potential offered by *You Bet* (with its winning combination of Bruce Forsyth, ridiculous scrapes, memory feats, etc). Too expensive? Then how about converting those '70s series which encapsulated heroism (*Man From Atlantis*) or non-stop adventure and intrigue (*The Love Boat*)?

### Sock it to 'em

Chopsocky films and oriental fighting techniques were introduced to the west mainly by Bruce Lee, so they've only proved popular in the last two decades. The on-screen enigmatic efficiency of disciplines such as kung fu and taekwondo hasn't taken long to filter through into machine code, bringing with it a greater emphasis on fighting than on the philosophical postures of defence.

**Batman (Above) was converted to a game that followed the film with extreme accuracy. Alien (Right) has, by contrast, had an indirect influence on space games such as Infestation (Below).**



Photo: Kobal

Photo: Kobal



**Again, *The Sentinel* (Above) is subtly influenced by the monolithic image around which *2001* centred; but *Star Wars* (Below) has given rise to a whole troop of direct conversions.**



From the simple arcade style action of *IK+* to the complex and rewarding *Budokan*, credit is awarded as much for turning opponents into jelly as for nodding politely to them before a bout.

### Monster munch

Monster movies aren't the most popular source of inspiration, but they do occasionally rise from the slime to expose their warty green heads and hairy bodies in computer games. There's plenty of dinosaur B-movie blood in Melbourne House's *Aaargh!* (but no Doug McClure, alas), and monsters make shy, fleeting appearances elsewhere.

Text adventures harbour insidious reptiles and eldritch beasts, a Godzilla-style lizard appears in *SimCity*, and (the monsters' finest hour), the werewolf in *Altered Beast* bears a striking resemblance to Oliver Reed in *Curse of the Werewolf*.

And what about *Rampage*, which was promoted by giving away free Chewits sweets because of the high television profile of a particular rampaging lizard? Tastier than Barrow-in-Furness bus depot...

### Pumping Iron

Palace's *Barbarian* and its sequel are in a class of their own. Featuring chunky portions of rippling muscle, unscrupulous monsters and moustache-twiddling bad guys, they fondly imitate the exploits of Arnie Schwarzenegger in *Conan the Barbarian*. Gore, big swords and loose-fitting underpants – what more could you want from a game?

### And for the Future?

Despite the currently widespread influence of films and TV shows on computer games, there's still great scope for novel translations from one medium to the other. No one has yet explored the method of drifting away from the spirit of an original idea – bringing out the beat-em-up aspects of *Bambi*, for example; or the high shoot-em-up quotient of *The Flumps*.

And there are plenty of ignored possibilities – how about a game based on the wacky happy-go-lucky scrapes indulged in by those loveable, cheeky *Double Deckers*? *The Elephant Man* is asking for a conversion because of the opportunities for sampled speech – who could hold back a tear when they heard the line "I am not an elephant, I am a man!" in the comfort of their own Amiga?

Maybe Cinemaware have plans to concentrate on games with strong emotional content, such as *The Sound of Music* – and surely it's only a matter of time before someone incorporates Richard Whiteley, quiz master extraordinaire, outrageously talented comic genius and literary giant, into their game design. ■

**STOP PRESS**  
Limited offer only  
Available only while stocks last,

**Superbase Personal**  
Great database programme with extensive features  
**Only £19.95**



# MERLIN

**NEW! AMIGA FLIGHT OF FANTASY PACK**

ESCAPE REALITY WITH THE ALL NEW 'FLIGHT OF FANTASY' GAMES PACK!  
Amiga A500 with Modulator, Mouse, 1 Meg Internal Disk Drive, 512KRAM, All Connecting Leads, Kickstart 1.3, 4096 Colours, Built-in Speech Synthesis, Multi Tasking, Workbench 1.3 System Disk, & Operation Manuals.  
Plus... **FOUR GREAT SOFTWARE TITLES**  
F29 Retaliator, Rainbow Island, Escape from the Planet of the Robot Monsters, Deluxe Paint II



Fantasy at a Truly Realistic Price of **£369**

## MONITORS

Including FREE Amiga Leads!

- COMMODORE 1084S**  
14" Stereo High Res. Colour
- COMMODORE 1084P**  
Mono Sound Version of 1084S
- PHILIPS CM8833**  
14" Medium Res. Colour

PHONE FOR NEW LOWER PRICE!  
**£225**  
**£249**

CHECK FOR LATEST PRICES & AVAILABILITY ON ALL MONITORS

FREE... 12 Months on site Maintenance with CM8833's

## DISK DRIVES

- VORTEX 40Mb Hard Disk** £499
- CUMANA CAX 354** £89
- 1 MEG. 3.5" Single**
- CUMANA CAX 1000** £129
- 1 Meg. 5.25" Single**

NEW! Rarier 3.5" Drive Only...£85!

## PRINTERS

Including FREE Amiga Leads!

- STAR LC 10 Mono** £169
- STAR LC 10 Colour** £209
- STAR LC 24 10** £249
- STAR LC 10 MkII** £185

Genuine Star Ribbons now Available!

## ACCESSORIES

- 10 - CBM OR TDK 3.5" DISKS** £14.95
- DISK STORAGE 40 Capacity** £6.95
- BOXES... 80 Capacity** £8.95
- MOUSE MATS** £4.95
- AMIGA KEYBOARD DUST COVERS** £5.95
- STAR PRINTER DUST COVERS** £5.95
- CM 8833 DUST COVERS** £5.95

## MORE AMIGAS

- AMIGA Class of the 90's Pack** £529
- AMIGA Comp. Pack\* + CM8833** £608
- AMIGA Comp. Pack\* + CM8833** £809
- +Star LC10 Colour Printer**

\*Either Flight of Fantasy or Batman Pack

## AMIGA BATMAN PACK

Amiga A500 with Modulator, Mouse, 1 Meg Internal Disk Drive, 512KRAM, All Connecting Leads, Kickstart 1.3, 4096 Colours, Built-in Speech Synthesis, Multi Tasking, Workbench 1.3 System Disk, & Operation Manuals.

Plus... **FOUR GREAT SOFTWARE TITLES**  
Batman, F18 Interceptor, New Zealand Story and Deluxe Paint II



The Ultimate Movie, The Ultimate Game, The Ultimate Price... **£369**

## CHOOSE ONE OF OUR 3 SORCERORS PACKS!

**ORDER SC-Ma**

**MOUSE MAT, DUST COVER, LOCKABLE 80 CAPACITY DISK STORAGE BOX 10 BLANK DISKS & JOYSTICK**

**ORDER SC-Mb**

**COMMODORE BARREL BAG & DISKETTE HOLDER, + COMMODORE KEYRING.**

**ORDER SC-Mc**

**COMMODORE - QUARTZ ANALOGUE SPORTS WATCH, MUG, KEYRING, BALLPEN AND SOLAR POWERED CALCULATOR**

## CHOOSE AN AMIGA FLIGHT OF FANTASY OR BATMAN PACK (As listed above)...

Your pick of any 1 Sorcerors Pack from the three detailed here for Only...

**£394**

(Individual Sorcerors Packs [ie without the A500] are available to purchase depending on our stocks, phone for prices and further details quoting the relevant SC number)

Inclusive of VAT and Postage!

### ALL OUR PRICES INCLUDE V.A.T. AND POSTAGE (UK Mainland)

Whilst every effort is made to ensure that the information shown on our advertisements is correct, you should ALWAYS confirm any Offers, Prices, Availability etc. prior to placing orders. Because our advertising is booked so far in advance, Merlin reserve the right to alter equipment specifications, withdraw any product/offer or update prices (either up OR down), without prior notice. ALWAYS CHECK DETAILS PRIOR TO ORDER. Merlin will NOT supply anything that has been subject to change without the customers prior permission.

**ORDERING:** Just phone our 24 hour order line using your Access/Visa card, OR, send a cheque/postal order with your requirement details. (Cheques need clearance prior to despatch)

**DELIVERY:** You choose either, by post at no extra cost, or simply add £5 per large item for next working day courier service. (UK Mainland)

**WARRANTY:** Goods that prove faulty within 30 days will be exchanged for NEW. After 30 days, & within 12 months, faults repaired at our expense.

# MERLIN

**EXPRESS LIMITED**

DEPARTMENT AMF/T5, UNIT D9. THE ROPE WALK INDUSTRIAL CENTRE, OFF STATION ROAD, ILKESTON, DERBYSHIRE, DE7 5HX. TELEPHONE: 0602 441442

**24 HOUR**  
Access  
**0602 42-44-44**  
HOTLINE  
VISA

GREAT VALUE, THAT'S THE MAGIC OF MERLIN

# HARWOODS

YOUR FIRST CHOICE FOR AMIGA

POWERPLAY

## HARWOODS LEGENDARY *Amiga* POWERPLAY PACKS

ALL OUR AMIGA POWERPLAY PACKS INCLUDE AN AMIGA A500 WITH...

- 512K RAM
- 1Mb Disk Drive
- 4096 Colours
- Multi-Tasking
- Built-in Speech Synthesis
- Mouse
- 3 Operation Manuals
- Workbench 1.3 System Disks
- Kickstart 1.3 Built-in
- All Connecting Cables

ALL OUR PRICES INCLUDE VAT AND STANDARD POSTAL DELIVERY SERVICE

*Plus you can now choose either Flight of Fantasy or Batman Software to go with Packs 1, 2 & 3 Absolutely Free!*

AND WITH PACKS 1, 2, 3 & 5 YOU GET AN EXTRA...

**BRILLIANT BONUS BUNDLE**

ONLY FROM GORDON HARWOOD COMPUTERS!!!

- Microprose Soccer
- Nebulus
- Menace
- Chessmaster 2000
- Trivial Pursuit
- Stryx
- Commando
- Phobia
- Voyager
- Archipelagos
- Deluxe Paint II
- Mouse Mat
- Microswitched Joystick
- Tailored Amiga Dust Cover
- Tutorial Disk
- TV Modulator (Packs 1&5 ONLY)

AND NOW... You get a Great Mystery Software Title FREE too!!!

### Amiga POWERPLAY

PACK 1

**'The' Games Pack**

Probably the Best Games Pack around. You won't need to buy anything else for ages and you'll be able to start to use your Amiga the moment it's out of the box!

Amiga A500 + Bonus Bundle

Only... **£399\***

Or spread the cost with our Finance Facilities

### Amiga POWERPLAY

PACK 2

**The Games 'Plus' Pack**

Containing the super Powerplay Pack 1 & a Philips CM 8833 Stereo Colour Monitor plus a Free Tailored Monitor Dust Cover!

Amiga A500 + Bonus Bundle + CBM 1084S Colour Monitor

Only... **£619\***

*See those Games even more clearly...*

### Amiga POWERPLAY

PACK 3

**The 'Extra' Plus Pack**

Take our 'Powerplay' Pack 2 and add Star's fantastic LC10 Colour Printer to give you the Ultimate Colour home entertainment computer system!

(If you prefer another printer simply deduct £209.95 and add the price of the alternative you require, choose from our lists)

Amiga A500 + Bonus Bundle + 1084S + Star LC10 Printer

Only... **£819\***

### Amiga POWERPLAY

PACK 4

**'Powerpro' Pack**

Amiga A500, Star LC10 Colour Printer, CM8833 Stereo Colour Monitor, 'Protex' Version 4.2 Word Processor, 'Superbase II' Database, 'Maxiplan 500' Spreadsheet, Tutorial Disk, and Deluxe Paint II' + Mouse Mat, Ten 3.5" Blank Disks with Library Case, Three Great Quality Dust Covers Tailored for Amiga, Monitor and Star Printer!

Amiga A500 + Bonus Bundle + 1084S + Star LC10 Printer + CM8833 + Star LC10 Printer + Mouse Mat + 10 3.5" Disks + 3 Dust Covers + 3 Quality Dust Covers + 3 Quality Dust Covers

Only... **£849\***

Remember you can choose alternative printers too!

### Amiga HARWOODS COMPLETE STUDENTS PACK

PACK 5

AMIGA A500 PLUS... Publishers Choice (DTP-Includes Kindwords Vers. 2), Midi-Master 1/Face, Dr. T's Midi Rec. Studio, BBC Basic Emulator, Maxiplan 500 S/Sheet, Superbase Personal D/Base, Amiga Logo, F18 Interceptor, Ten Blank 3.5" Disks with Disk Wallet,

PLUS OUR 'BRILLIANT BONUS BUNDLE' FREE!

Only... **£549\***

REMEMBER TO CHOOSE EITHER YOUR FREE 'BATMAN' OR FREE 'FLIGHT OF FANTASY' SOFTWARE COLLECTION A OR B WHEN YOU BUY YOUR HARWOODS POWERPLAY PACK 1, 2 OR 3

BATMAN THE MOVIE *Collection A*

Batman The Movie  
New Zealand Story  
F18 Interceptor



FLIGHT OF FANTASY *Collection B*

Escape from the Planet of the Robot Monster  
Rainbow Island  
F29 Retaliator

## HARWOODS THE NAME YOU CAN TRUST



### FINANCE FACILITIES

Gordon Harwood Computers offer facilities to pay by our budget account scheme for most items. APR 36.8% (Variable). Credit sale terms are available to most adults of eighteen years or over, subject to status. Simply phone or write and we will send written details along with an application form. Applications are required in advance and are available to full time U.K. mainland residents only. Written quotations available on request.

\* Credit sale terms with or without a deposit, can be tailored to suit your needs.

### ORDERING MADE EASY - COMPARE OUR SERVICE

- ORDER BY PHONE:** Phone our Order Hotline with your Mastercard, Access, Visa or Lombard Charge Card quoting number & expiry date.
- ORDER BY POST:** Make cheques, bankers building society drafts or postal orders payable to GORDON HARWOOD COMPUTERS. (Personal or business cheques take 7 days to clear from day of receipt before your order is despatched) Please send Name, Address, and most importantly if possible, a Daytime Telephone Number along with your order requirements.
- TO PAY BY GIRO TRANSFER:** at your own bank, simply phone us for details (Transfers normally take 3-5 working days).
- FREE POSTAL DELIVERY:** Goods in UK Mainland (5-7 day delivery).
- OR COURIER SERVICE:** Add £5 per major item for next working day delivery, UK Mainland most regions. (Goods normally despatched on day of ordering or payment clearance)

**EXPORT ORDERS:** Most items are available at TAX FREE PRICES to non UK residents when visiting us or for export shipment. Please contact us for ordering information.

REMEMBER AFTER YOU'VE BOUGHT FROM HARWOODS, WE'LL STILL BE HERE...

**TECHNICAL SUPPORT:** You will be given our Exclusive Technical Support Phone Number to call should you require any help or advice on any aspect of the system you have purchased.

**12 MONTH WARRANTY:** New items proving faulty within 30 days of purchase are replaced with NEW UNITS unless otherwise stated. For the whole guarantee period, all warranty service will be completely FREE OF CHARGE and a FAST turnaround is GUARANTEED by our OWN ENGINEERS!

**COLLECTION FACILITY:** Any computer, monitor or printer requiring warranty service can be collected from your home FREE OF CHARGE during the guarantee period (UK Mainland only)

**FULL TESTING PROCEDURE:** All computers are tested prior to despatch, and all items are supplied with mains plug and leads as required - just connect up and use straight away.

# RPLAY

folio

## MONITORS

### PHILIPS CM 8833 STEREO

Full 14" Stereo High Resolution Colour Monitor

- SCART Euro-connector fitted as standard
- RGB/Al, TTL, Comp. Video & stereo audio inputs
- Can also be used as a TV with tuner or VCR
- Features fold down tilt-stand  Twin Speakers
- FREE lead for computer of your choice
- FREE 12 Month on site service warranty. \*

Plus a Free Tailored Dust Cover...

**£249**

### COMMODORE 1084 S

Full 14" Stereo High Resolution Colour Monitor

- RGB/Al, TTL, Composite Video & Audio Inputs
- Can also be used as a TV with a tuner or VCR
- Twin Speakers
- Supplied with cables for A500, CGA PC, C16-64-12B

With Free Tailored Dust Cover... \*

**£259**

## STORAGE DEVICES

### HARD DRIVES

**COMMODORE A590 20Mb HARD DISK DRIVE FOR AMIGA A500, WITH FREE 0.5 Mb MEMORY**  
Commodore's own hard drive for the A500

- Autoboot with Kickstart 1.3
- Sockets for up to 2Mb RAM expansion
- DMA access  External SCSI port
- SUPPLIED WITH A FREE... 0.5Mb MEMORY EXPANSION

Super Low Price...  
**£399** \*

**A590 HARD DISK (As Above) WITH 2Mb MEMORY**

- Expansion fitted and ready to use straight away

**NEW LOW PRICE ONLY...£499.00\***

**40Mb VORTEX HARD DRIVE FOR BOTH AMIGA A500 AND AMIGA A1000**

- For both A500 and A1000 as supplied
- Autoboots on ANY Amiga

**GREAT VALUE AT ONLY...£499.00\***

### FLOPPY DRIVES

#### EXTERNAL FLOPPY DISK DRIVES

The drives listed below have the following features...

- Enable/Disable switch
- Throughport
- LED Access light, super quiet
- Suitable for A500, A1000, A2000

**CUMANA CAX 354 3.5" SECOND DRIVE**

- 25mm Super slimline 3.5" drive

**A REAL BARGAIN AT ONLY...£89.95**

**CUMANA CAX 1000S 5.25" SECOND DRIVE**

- Amiga DOS and MS DOS compatible

**SAVE MORE THAN EVER...£129.95**

**HARWOODS SUPERSLIM 3.5" SECOND DRIVE**

- Extra storage and great value too!

**'SUPERSLIM PRICE' ONLY...£64.95**

Free Tailored Dust Cover With Every Star Printer Bought!

## PRINTERS

All printers in our range are Dot-Matrix and include the following features...

Standard Centronics parallel port for direct connection to Amiga, PC's, ST etc. and come with...FREE CONNECTOR CABLES!

**STAR LC10 - 120/25 cps**

Our most popular Mono Dot-Matrix printer and at a super low price

- Multiple font options from front panel
- Excellent paper handling
- Simultaneous, continuous and single sheet stationery
- 240 x 240 dpi Graphics

**£159.95\***

**STAR LC10 MkII - 150/30 cps**

Brand new superfast MkII version of the ever popular LC10 printer.

**£179.95\***

**STAR LC10 COLOUR - 120/25 cps**

Colour version of the LC10

- Same font & paper handling as LC10/LC10II
- Allows full colour dumps from Amiga
- Superb text quality
- 240 x 240 dpi Graphics
- Can use black LC10 ribbons
- Our most popular colour printer!

**£209.95\***

**STAR LC 24 10 - 180/60 cps**

24 Pin version of the Star LC Series with

- Exceptional letter print quality
- 360 x 360 dpi Graphics
- Additional font cartridges available
- 8 resident fonts

**£239.95\***

**STAR XB24 10 COLOUR - 240/80 cps**

Very fast LQ 24Pin Colour Printer

- Exceptional print quality
- 4 x 48Pin super letter quality fonts
- 24 x 24Pin near letter quality fonts
- Huge 27K buffer expandable to 187K
- 360 x 360 dpi Colour Graphics
- Our best colour printer
- 12mths on site warranty (UK Mainland)

**£479.95\***

**STARSCRIPT - 8ppm POSTSCRIPT LASER**

- 300 DPI, 2Mb. Memory upgradable to 5Mb.
- Emulations include: HP Series II, Epson EX800, IBM Proprinter and Diablo 630
- Serial/Parallel printer interface built-in
- Includes 12mths on site warranty (UK Mainland)
- Every desktop publishers dream

**£1995.00\***

**CITIZEN SWIFT 24 PIN COLOUR - 160/50 cps**

Most competitive 24 Pin Colour Printer available Today!!!

- Push and pull tractor built-in
- Additional bottom feed for labels/multi-part stationery
- 360 x 360 dpi Colour Graphics
- 2Year Citizen warranty (UK Mainland)

**£339.95\***

**CITIZEN SWIFT 9PIN COLOUR - 160/40cps**

New super high spec 9Pin colour printer

- 8K Buffer
- 4 Fonts
- Push and pull tractor built-in
- Additional bottom feed for labels/multi part stationery
- 240 x 240 dpi Colour Graphics
- Best text quality in our 9Pin range

**£249.95\***

**CITIZEN 120D - 120/25 cps**

Very reliable low cost printer

- Interchangeable interfaces for Centronics RS 232 or Serial type for CBM 64 etc
- 2Year Citizen warranty (UK Mainland)

**£149.95\***

Characters Per Second speeds quoted are Draft/LQ at 10cps

A FULL RANGE OF PRINTER RIBBONS ALWAYS AVAILABLE

We are proud to announce that Star have appointed Gordon Harwood Computers as both a Star Corporate Preferred Reseller and Star Gold Dealer in recognition of our commitment to their products and the levels of service and support we provide...  
**MAKE HARWOODS YOUR FIRST CHOICE FOR STAR PRINTERS**

### SUMMER CLEARANCE SALE

PRODUCTS AT LESS THAN ADVERTISED PRICES!!!  
PHONE NOW for details of our EX-DEMO and REFURBISHED STOCK;  
Just about every product we sell at VERY SPECIAL PRICES and...  
ALL with a WATERTIGHT GUARANTEE now available!

**SAVE £££'s...SAVE £££'s...SAVE £££'s**

## ACCESSORIES

### COMMODORE

**A501 RAM PACK** £99.95

GENUINE CBM ram pack with real time battery backed clock. This add-on DOES NOT invalidate Commodore's warranty.

**A520 TV MODULATOR** £19.95

**QUALITY ACCESSORIES**

**NAKSHA Microswitched Mouse** £29.45

**FLOPPY DISKETTES**

**10 GENUINE COMMODORE 3.5" BLANK DISKS** £9.95

**QUALITY CERTIFIED 3.5" BULK DISKS (supplied with labels)**

Ten, with library case **£9.49**

Ten, uncased **£8.49**

Eighty, uncased **£49.95**

Hundred, uncased **£59.95**

Eighty with LOCKABLE storage case **£54.95**

PHONE FOR LARGER QUANTITY DISCOUNTS!

## Amiga SUNDRIES

DIEGO'S SPECIAL OFFERS...DIEGO'S SPECIAL OFFERS

**MUSIC X - FULL VERSION-SOFTWARE** £79.95

**512K RAM UPGRADE** £64.95

Including... 'It Came from the Desert' and FREE...

Mystery Major Amiga software title and Utility Software Disable Disk.

## GRAPHICS HARDWARE

**DIGIVIEW GOLD 4.0 VERS. 4.0**

Digitises static images in Black and White or FULL COLOUR (using filters provided) and all resolutions supported (memory permitting).

Creates IFF and HAM files. Uses B&W (or colour with B&W mode) video cameras.

**NEW LOWER PRICE... £119.95**

**HITACHI VIDEO CAMERA**

Mono, 650 scan lines. For photographic quality digitising with Digiview!

**£284.95\***

**COLOUR PIC REAL TIME FRAME GRABBER**

Instant colour frame grabber from moving video. Capture superb digitised video images in a range of resolutions from standard composite video source such as domestic TV video recorder or camera in 50th of a second.

**Super Price...£439.95\***

**RENDALE GENLOCKS**

**8809 SEMI-PROFESSIONAL £189.95**

Complete with SOFTWARE CONTROL CABLE & BNC to PHONO CABLE!!!

**8806 PROFESSIONAL £749.00\***

**FASTORDER HOTLINE-0773 836781**



### VISIT OUR SHOWROOM

Please pay us a visit where our full range of advertised products, AND MORE, is on sale. Come and see for yourself amazing Amigas and a whole host of peripherals, software and accessories.

REMEMBER, WE ARE NOT JUST ANOTHER MAIL ORDER COMPANY

**STOP PRESS...STOP PRESS...STOP PRESS**

During Aug/Sept we'll be moving to our new purpose built showroom and warehouse facility in Alfreton. We'll then be able to offer an even more extensive service, but, don't worry if you need to contact us quickly our phone numbers will stay the same. Watch our future ads.

All listed prices are what YOU PAY, and there are NO HIDDEN EXTRAS! VAT and postage are included and prices are correct at time of going to press (Pack details may vary from time to time). E & O.E. Offers are subject to availability and are currently advertised prices.

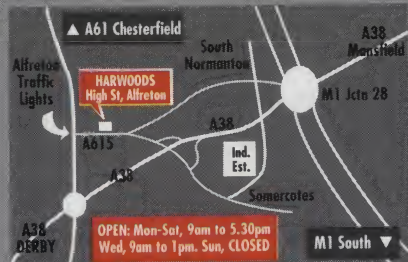

OPEN: Mon-Sat, 9am to 5.30pm  
Wed, 9am to 1pm. Sun, CLOSED

# GORDON HARWOOD HARWOOD HARWOOD Computers

**GORDON HARWOOD COMPUTERS**  
DEPT. /B9, 69-71 HIGH STREET  
ALFRETON, DERBYSHIRE, DE5 7DP  
TEL:0773 836781 FAX:0773 831040

*First we destroyed you with Battle Squadron!  
Now only you can purge the planet from...*

# The Plague



**A**s a deadly plague slowly expands through an enormous experimental breeding ground, the genetically malleable inhabitants degenerate into hideous mutants. If the plague is not contained, the entire planet will be lost to a seething whirl of lawless acts and monstrous beings! Only by your laser-sharp surgery can the plague be stopped!!

***It's Arcade!  
It's Action!  
It's Amiga!***

- Sensational soundtrack and spectacular sound effects.
- 42 colors on a full screen for beautifully detailed 3D graphics.
- Four different long playing levels of game-play.
- A unique High Score System which allows you to write your own signature in the Hall of Fame.

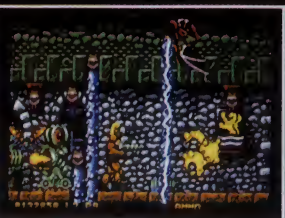

The  
*Software*  
Business

**NOW AVAILABLE FOR AMIGA**

**RRP £24.95**

**INNERPRISE**  
SOFTWARE, INC.

Marketed by The Software Business Ltd, Brooklands, New Road, St Ives, Cambridge, PE17 4GB. Tel: 0480 496497



# Special Effects:

**H**ow often do you come across a juggling mono-cycle at the bus-stop or a marble leopard leaping across your garden? Never? Me neither, but thanks to computer graphics these and many other impossible realities are rapidly encroaching on the ordinary in our lives. Indeed, they are becoming ordinary themselves, at least within the pseudo-reality of the TV screen.

Over the next couple of issues, *Amiga Format* Graphics will be concentrating on the contribution that the Amiga is making to this weird, transformed reality. In particular we will be looking at the special effects capabilities of the Amiga – starting with 3D surface mapping.

As usual, the subject will be covered in our thorough way with details of all the techniques and where to find them, explanations of all the jargon and tips on how to get the best results:



Quite surprisingly, considering that our beloved computer is so completely suited to graphics techniques, only a few graphics packages offer any sort of surface mapping facilities. The reason is not very difficult to deduce – time. Almost any form of mapping technique takes an awful lot of computing power to complete, and some of the time-scales involved are almost geological.

Nevertheless, if a modelling package is to be taken seriously as a means of representing realistic objects and scenes it must be capable of displaying a variety of surface

textures, even if you do have to be very patient to actually see them. The packages used in this article are *Photon Paint 2* (Micröllusions), *SculptAnimate 4D Professional* (Byte By Byte), *Turbo Silver* (Impulse), and *Forms In Flight II* (Micro Magic). Other packages do give some choices of surface effects, but only these four provide any real control.

## Why Surface Mapping?

As computer-generated images have become more commonplace, one of the main criticisms leveled at them has been their uniform, unnaturally plastic appearance – those smooth, shiny, snooker-ball surfaces.



# Mapping THE World

In the first of a series on special effects in computer graphics, **BRIAN LARKMAN** concentrates on surface texture mapping.

This smooth surface is, of course, a product of the algorithms used to give angular, faceted objects a rounded look without using thousands of memory-hungry points and lines in the model. (See the *Sculpt-Animate* tutorial in *Amiga Format 5*.) These algorithms are relatively simple, idealised models of the world, whereas the real thing is much more complex, having texture and imperfections that would require millions of points and facets to render.

To overcome this surface perfection without increasing the complexity of the model a number of strategies have been evolved. Most of them involve mapping details onto the

# AMIGA FORMAT

## PRO DRAW REVIEW

actual donut itself, this should make things clearer. As always, such operations are considerably easier to do than to actually explain.

### A New Blend

Another new feature is the colour blending operation. This is a little bit like the colour spread function to found within *DPaint*. Simply by creating two objects, one containing the start colour and one containing the end colour, *ProDraw* will create a spread of colours between the first and second objects. Used properly, this blend operation can create some breathtaking shading effects. For an example, check out the illustration on the previous page.

In true DTP style, the number of colours available for colour blending isn't restricted by the colours available from the computer. Using Postscript colour separation, you can define as many steps between one colour and another as you require. *ProDraw* displays these colours on-screen using dithering.

The blend function isn't just restricted to producing colour spreads. It can also be used to create transformations between two objects. For example, if you created two objects, one in the shape of a caterpillar, and one the shape of a butterfly, *ProDraw* is capable of creating a series of objects depicting the transformation between the first object and the second.

### Text Control

Text within *ProDraw 2* is no different from any other object. Every letter of every word that you place on the screen is built up from smaller graphic objects. Each letter can therefore be edited in the same manner as any other object within *ProDraw 2* - you can resize, colour, distort and rotate letters, and even 'hook' any of the individual points that make up a letter.

*ProDraw 2* uses the same Compugraphic outline fonts as used by Gold Disk's other DTP products, *Professional Draw* (Version 1.3) and *PageSetter 2*. Rumour has it that Commodore may build direct support for these outline fonts into a future release of the Amiga operating system, so obtaining additional fonts shouldn't be too much of a problem. The package comes complete with two outline fonts, Times and Triumvirate, but the company plan to release a whole series of Outline Fonts themselves which are available separately at a price of £139.95.

Once you've plonked your text onto the page the fun really starts. Using *ProDraw's* powerful text distortion tool, it is possible to manipulate the text in ways that were previously thought impossible on an Amiga. Text can be sheared in either the X or Y axis, moved in 3 dimension perspective (just like in *DPaint*), twisted and distorted beyond belief.

*ProDraw 2* also allows any string of text to follow a defined path. Simply by creating a path using the freehand pen tool, text can be made to follow a path of any shape or size across (or even around) the page, as shown on the left. *ProDraw 2* includes an extensive range of options to allow you to specify how this text curve alignment should take place.

### Output Options

Although *ProDraw 2* was designed to complement Gold Disk's own DTP system, *Professional Page*, it can also be used with other page layout and illustration packages on both the Amiga and other systems. This is achieved using EPSF (Encapsulated Postscript Format) files. As long as the DTP system you are using supports EPSF, then chances are that your *ProDraw 2* images can be pulled in and used without modification. *ProDraw* can also read EPSF files, therefore making it possible to edit structured drawings produced by similar programs such as those to be found in abundance on the Macintosh.

Once you've created your image, you'll may wish to print it straight out without bothering to pull it into a DTP

package first. *ProDraw 2* supports both HPGL plotters and Postscript printers, as well as the more common preference-supported dot matrix printers. For postscript users, *ProDraw 2* includes extensive colour separation facilities. Unlike a bitmapped image, the quality of the final printout is dictated only by the quality of your printer.

### Draw to a Conclusion

The only real thing that holds *ProDraw 2* back is the Amiga itself. Even if you're lucky enough to have an Amiga with something like 9 megabytes of RAM, those dreaded Chip RAM warnings still manage to pop up all too frequently. The addition of a 1 Mb Agnus goes some way to solving this problem, but even then the chip RAM bottle-neck still proves to be a problem. *ProDraw 2* only really becomes usable for larger projects if you run it in medium resolution, which unfortunately has the adverse effect of removing much of the on-screen detail.

Gripes aside, *ProDraw 2* is simply breathtaking. Previous Gold Disk products have unfortunately suffered from operation speed problems, but *ProDraw 2* is fast both in use and in rendering. Although initially daunting, creating stunning artwork soon becomes a doddle, which is helped still further by its impressive range of editing features. If you're serious about your desktop publishing, *ProDraw 2* is a must.

**PROFESSIONAL DRAW 2**  
£199.95 ■ 1 Mb Amigas ■  
HB Marketing 0753 686000

CURVED TEXT IS EASY WITH PROFESSIONAL DRAW 2...

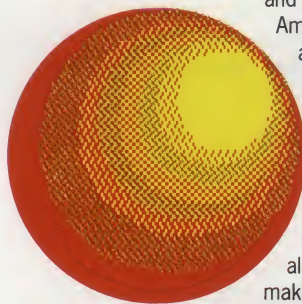

## FROM BITMAP TO VECTOR...



If you already have a large collection of bitmapped clip art, then you certainly won't want to scrap them when you start to use *ProDraw 2*. Thankfully, the program provides two different methods of converting bitmapped artwork to IFF. The first involves loading the bitmap straight into *ProDraw* and then manually tracing over the top of the image. Although this can produce some very good results, it can be very time consuming.

A more favourable solution comes in the form of *ProDraw's* Auto-Trace facility. Included on the *ProDraw* disks is a separate utility that can be used to automatically convert IFF bitmaps to structured objects. Using a digitiser such as *Digi-View*, it is perfectly possible to pull structured images of real-life objects straight into *ProDraw*. This utility alone makes *ProDraw 2* the best structured drawing tool available on the Amiga.

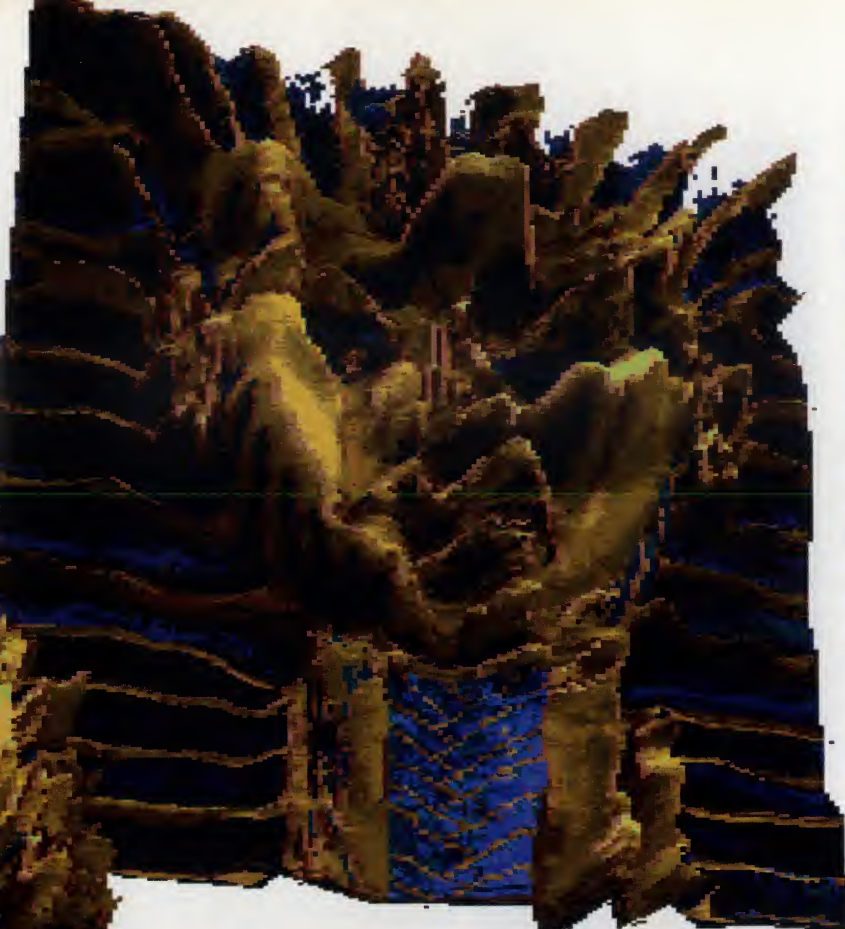

## CONTOUR MAPPING

The contour mapping facility in *Photon Paint* produces this sort of remarkable effect. Comparison with the original of KINGTUT shows that the highpoints of the contoured picture correspond to the brightest areas and the low points with the darkest. *Turbo Silver* has a 'Terrain Module' that should produce a similar effect. See *Amiga Format 14* for examples of this remarkable effect.



## TEXTURE WRAPPING

Texture mapping can be achieved using a picture of the required texture wrapped onto an object (as in the case of the *Photon Paint* picture of a brick pattern below right) or using a procedural description of the texture that is used to construct the object during rendering.

This is the method used for the *Silver* brick pattern shown lower right.

The final effect is, once again, much more convincing with *Silver* (although one of the parameters concerned with the number of layers of bricks going back into the picture produces the curious circular patterns of mortar. This effect will be explored in the tutorial in the next issue of *AF*.)



Contour Mapping in *Photon Paint 2* is also unique in that it involves converting a 2D picture into a 3D contour map before mapping another picture onto it. The contours are determined by assuming that the Value of each pixel (as in HSV - Hue, Saturation, and Value) represents its relative height. In other words the lighter the pixel the higher it is, the darker the pixel the lower it is. When it comes to mapping textures onto the folds of plain cloth or a face, this method is amazing - ideal for textile designers.

If a 3D model is to be animated, bitmapped textures wrapped onto it must cover the surface uniformly, front and back. Both *Turbo Silver* and *Forms In Flight II* (FiFiI) do this but they use different methods.

*Silver* wraps about each axis in several ways that are obvious when you see them but difficult to describe - so I won't. *Forms In Flight II* maps IFF pictures onto 'QSURFs' (normally known as SURFACE PATCHES). Again, these are difficult to describe - but I will.

A surface patch is a four-sided object that, in its simplest form is square and flat. If each of the sides is distorted, the patch can be made to occupy a 3D space. It is easiest to imagine as the patch on the knee of a pair of jeans. it starts out flat and squarish but once the legs arrive in them and the knee is bent the patch distorts into a 3D shape - a surface patch. In FiFiI, an object can be made up of many QSURFs, each of which can have a different IFF texture attached to it.♦

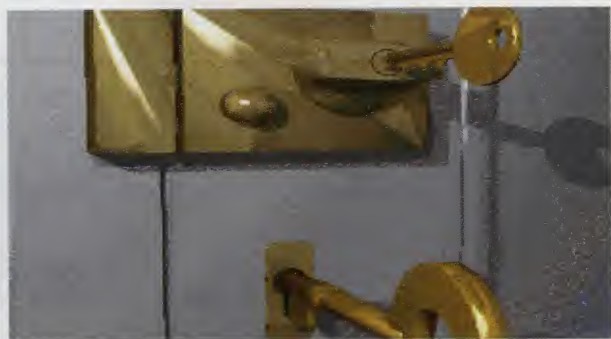

## SCULPT-ANIMATE SURFACE TEXTURES

Although *Sculpt-Animate 4D* has no texture mapping facilities, it does have some 'Coded' textures that work very effectively when used with some imagination and skill - as in this illustration produced by Paul Cowan of Electric Pictures in York.

The Metallic texture applied to the lock is about 50% reflective so some of the key and the surrounding environment can be seen. The art of using reflective surfaces is to provide something to be reflected. We will discuss this problem and some very effective solutions that Paul has devised in a future issue of the graphics section.



## PICTURE MAPPING

The basic process of texture mapping is wrapping a bit-mapped picture onto an illuminated 3D object so that the original palette (in this case the 32 colours of the Tutankhamun picture) is transformed to give the effect of shading and highlights.

surface in one way or another. Natural-looking imperfections and textures can now be added quite effectively and, as a bonus, bizarre and unnatural images and textures can be wrapped around objects and animated – hence the marble leopard.

Some of these strategies and the degree to which they can be achieved with the software available on an Amiga, are described below and in the boxes on these pages.

Another widespread criticism of computer generated images involves the use of the now totally clichéd checkerboard pattern. This standard background is used mostly to provide perspective clues to give the picture a sense of depth. Surface mapping tends to give a much more realistic feeling with its subtler variations of detail, enlarged near the viewer and reduced with increased depth into the scene.



**Photon Paint offers some control over illumination with its intensity, contrast and dithering sliders, plus light direction selector. Nevertheless, the final effect can be difficult to get right.**

### Surface Mapping Techniques

A certain amount of confusion has arisen in this subject because of the jargon. The methods used are often variations on the same theme and the terms used to describe them have been applied in different ways, especially by the manual writers for the various Amiga software packages. In an attempt to clear things up a little we shall examine the various techniques and attempt to define them. These definitions are not universal – but are those most often used and seem the most logical.

**TEXTURE MAPPING** is the most commonly-used term (and seems to be synonymous with 'Surface Mapping') to describe the general action of applying a texture or picture to an apparently 3D object or surface in perspective. Sometimes Texture Mapping is distinguished from Contour Mapping and Bump Mapping (described below) but generally these can be thought of as variations of the basic technique.

The texture to be applied can be constructed in one of two forms...

**BITMAPPED TEXTURES** are usually normal IFF picture or brush files that could represent textures – marble, wood, metal, grass etc – or any other image, such as a face, a machine, a landscape or the like. **CODED TEXTURES** are defined by an

algorithm that controls their basic nature – the flow of grain in wood or marble, the size and distribution of speckles in stone, the distribution of mosaic tiles, the colour and reflectiveness of metal etc.

In some packages (such as *Sculpt-Animate*) the choice of coded textures may be quite general with pre-defined characteristics – dull, shiny, reflective, metal, glass. In others (like *Turbo Silver*) the nature of these properties is under the user's control with sliders – the degree of reflectiveness and the refractive index, for example, define how much light is reflected, absorbed or transmitted by an object.

Some coded textures allow even more control. Each of the special 'plug in' textures of *Turbo Silver* have a set of parameters that can be changed to completely alter their nature. Bricks, for example, can have their mortar colour and thickness defined as well as the offset of the bricks and the axis of the courses.

In general, surface mapped textures create the illusion of detail on the surfaces they cover but closer inspection reveals that they are flat and without irregularities, rather like brick-effect or wood-effect wallpaper...

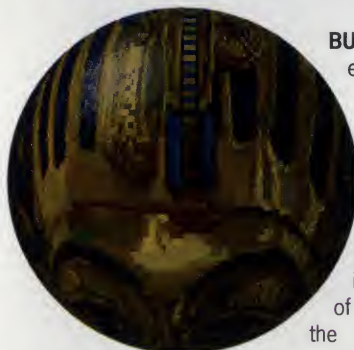
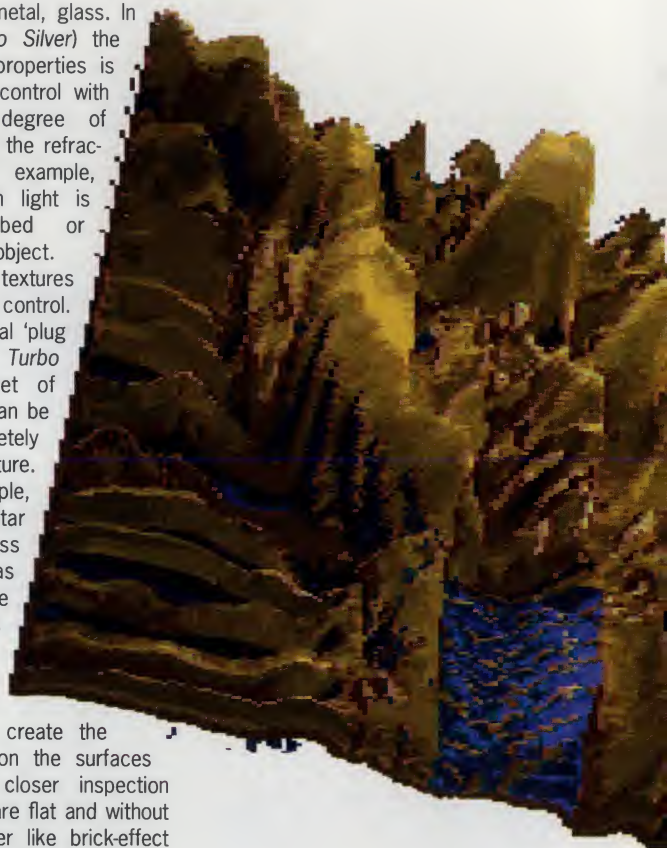

**Silver has a similar range of controls but they are easier to use and the final effect is very much more realistic and 3D looking. The blend of shades and highlight is beautifully smooth and the distortion of the original picture is much more convincing.**

**BUMP MAPPING** creates the even more realistic illusion that the texture is embossed into the surface, casting shadows depending on the light sources set up in the model scene. This is achieved by uniformly varying the detailed illumination of the surface while calculating the shading effects created during ray-tracing.

Perhaps the most famous example is the 'golf-ball' texture used in the opening credits of *Tomorrow's World*, but anything from leather to bark or fish-scales can be simulated over any object. So far, no Amiga software package offers bump mapping but it is probably only a matter of time, now that O20 and O30 accelerator boards are becoming cheaper and more widely available. Bump Mapping in particular is very time intensive.

The way that textures are wrapped onto surfaces varies from program to program. Most coded textures are applied to 3D objects face-by-face so that a rotating sphere, for instance, would have a continuous

texture of completely unbroken detail mapped across its surface.

Bitmapped textures can be applied in several ways. The most straightforward technique is to imagine that the original IFF picture or brush were projected onto the object like a slide transparency. If the object is a simple 'primitive' shape such as a sphere or cube, the illusion is created by simply distorting the picture, shrinking some areas and enlarging others. This technique is used by *Photon Paint* for its basic texture mapped effects, and *Deluxe Paint III* for its Wrap effect.

More sophisticated wrapping effects can be achieved by mapping the texture onto the contours of objects...

**CONTOUR MAPPING** of this sort is employed by *Photon Paint 2* for Wrap On Contour and by *Turbo Silver* for Brush Illumination. By allowing the 2D picture to be re-oriented in 3D space and treated as a source of illumination, this works exactly like slide projection, wrapping the picture directly onto every object that it illuminates – a unique effect.

# G.T.S.

## GEORGE THOMPSON SERVICES

### SOFTWARE EXCELLENCE

*Presents Their All New! "Summer Holiday Special!"*

**\*\* GTS CLUB \*\* GTS CLUB \*\* GTS CLUB \*\* GTS CLUB \*\***  
**"HAVE YOU JOINED THE LEADING PUBLIC DOMAIN CLUB FOR AMIGA ENTHUSIASTS? CONSIDER THE ADVANTAGES"**



- ★ RECEIVE THE LATEST AND THE FINEST PD FROM THE U.S.A., EUROPE AND AUSTRALASIA
- ★ PAY LESS FOR HARDWARE AND SOFTWARE
- ★ TALK TO 'AMIGA ONLY' ENTHUSIASTS

Since the early days of the Amiga, George Thompson Services have made available to Amiga Owners all over the world the latest PD disks from the U.S.A. and Europe. Couriers deliver material each week to our offices where we first carefully check them for virus. They are then catalogued and released to the duplicating rooms for labelling and copying onto top quality branded TDK disks. As a member of this very Special Club you will not only benefit from lower PD Software prices but also discounts on specialized hardware. Send only £15.00 annual subscription now and you'll receive by return:

- ★ Our Double Disk Library Pack detailing the contents of 100's of PD disks.
- ★ The "Birthday Issue of JUMPDISK as advertised.
- ★ The latest issue of MEGADISK as advertised.
- ★ £5.00 PD Discount Voucher for use against the purchase of 10 or more individual PD disks at £2.75 each. You can also choose one free!
- ★ A copy of the bi-monthly publication 'PD News'.

To become a member of the "GTS CLUB" just send a cheque, P.O or place a credit card order using Access/Visa and we will send this pack to you immediately!

**●● NEW...NEW ..."FAMILY COMPUTING"...NEW...NEW ●●**

*New Additions to this Popular Series - Only from GTS*



**"HOME MANAGEMENT" £5.99 (£5.49 Members)**

Two Disks packed with programs for the busy housewife. Prepare shopping lists, keep track of your finances, make a note of all those important names, addresses and telephone numbers, etc. Includes full instructions on disk.

**"IN THE KITCHEN - PART 1" £5.99 (£5.49 Members)**

Need to keep an eye on the calorie intake? Having problems with the Metric Conversion? Looking for that favourite recipe? This very useful two disks set will prove an invaluable kitchen aid.

**"CATALOGUE WORKSHOP" £5.99 (£5.49 Members)**

How many times have you wanted to catalogue your Video Cassette Labels? Print Disks Labels? Catalogue your GTS PD collection? Search for that PD program you know is somewhere? This two disk pack enables you to do this and much more!

**"A CLASSICAL EXPERIENCE" £5.99 (£5.49 Members)**

Two disk packed full of Sonix Classical Music Compositions. Features individual track mode as well as continuous play. Includes works of well known classical composers in full Stereo. A listening experience!

**STILL AVAILABLE! "LEARN & PLAY" £5.99 (£5.49 Members)**

This two disk set features programs for ages up to 7/8 years old. Easy to use and ideal for children who are just starting to use the computer. Includes Simple Maths, Colouring Book, Word Puzzles, Spell Test and much more!

**●● HAPPY 4TH BIRTHDAY TO JUMPDISK ●●**

The 48<sup>th</sup> Issue of the "Best Selling Magazine on a Disk" is the best yet! Packed with Eleven Top Quality Programs, Tutorials, the Latest News and so much more. Program highlights include the latest and best Virus Killer "Zero Virus III". "WonderSound" creates your own instruments for use with your music programs. Display art while playing music with "Music". Teach the Amiga to pronounce words correctly with "SayRight" and follow the new tutorial "Art Course". Relax with the arcade game "PowerHitter" and attempt to solve the Graphic Puzzle Game "Hotspots". A cornerstone in Amiga Computing for only £8.50 (£6.99 Members).

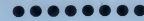

**●● NEW...NEW... "MEGADISK" ...NEW...NEW ●●**

It's available in the U.K. at last! Australia's own Top Selling Magazine on a Disk. Full of Reviews, Technical Tips, Hardware Projects, Tutorials, Useful Programs, Art, Readers' Letters...the list goes on! Like to know how to put Kickstart in ROM? Make a real Monitor from a TV? Learn about Synthesizers, Accelerator Boards, Spreadsheets and Skypix Coms. Read about a Cordless Mouse, Hard Disk Interfaces and Taking Care of your Amiga. Add a generous helping of programs and you have Issue 16 of MEGADISK! At just £8.50 (£6.99 Members) ONLY FROM GTS!

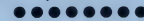

**"THE COMPLETE DESKTOP VIDEO PRESENTATION PACK"**

New to the GTS stable of Quality Software at realistic prices, is a collection of programs that have been professionally presented by the Los Angeles Amiga User Group on four disks. They contain a wealth of useful programs that should solve all of your video and slideshow presentation problems. This unique pack costs only £10.99 (£9.99 Members).

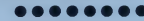

**●● NEW...FOR ROLE PLAYERS ONLY" £10.99 (£9.99 Members)**

If you enjoy Role Playing Graphical Adventures, this pack is for you! Our Librarian has picked the "cream of the crop" for this four disk set. And if you order before the end of July we will include Germany's top-selling RPG game absolutely FREE! (Most programs require 1 Meg).

**●● NEW... "PLAYING CARDS WITH THE AMIGA" £5.99 (£5.49 Members)**

Two disks packed with the very best card games to appear on PD. Includes all of the well known games plus variations of Patience.

**●● NEW... "BEST OF MEGA GAMES" £10.99 (£9.99 Members)**

During the past 2 years GTS have released quality PD Games in 3 packs. For those that missed them we have chosen the very best for this 4 disk pack. What better way to spend the Summer holidays with your Amiga?

**●● NEW... "MINI GAMES PACK VOL 1" £5.99 (£5.49 Members)**

During the past few weeks GTS have received the latest PD/Shareware games releases. The best are included on this very special two disk set.

**●● NEW...SPACE ODDYSEY" £5.99 (£5.49 Members)**

A database containing data for all 368 man related Space Missions of the USA and USSR from the beginning of the Space Age plus many superb HAM pics on 2 disks.

Our Promise to you, the customer, is to provide top quality programs, professionally presented, on the best media TDK DS/DD branded disks - at value for money prices.

We send all software in "bubble envelope" by first class post.



Our keyword is "Customer Service" with a smile  
**WE ARE GEORGE THOMPSON SERVICES**



Our address is:

**DIPPEN, BRODICK, ARRAN, SCOTLAND, KA27 8RN. (077082) 234.**  
 Please send a cheque (with your Bank Card No. Expiry Date on Reverse), a PO or just telephone your Access or Visa Card details to us before 1pm and we will despatch your order immediately.

**"Lou, hold page one! PUBLIC DOMAIN NEWS IS HERE!"**

*This new bi-monthly publication is full of Reviews, Details of the Latest PD and Shareware Releases, Letters, Hints & Tips, Pilots Lounge, Tutorials, How to get the most out of PD plus much, much, more!*

*What Lou? I got no time to fill you in. Best you take out a £4.99 Annual Subscription for the full story. And say Lou, did you know if you subscribe before the end of July, GTS will include a PD SURPRISE absolutely FREE!"*

If you would like to receive PD NEWS on a regular basis why not follow our "Ace Reporter's" advice and complete this coupon. By return you will receive the latest issue of PD NEWS and the Software Surprise (RRP £4.99) plus Issue One FREE!

We are George Thompson Services, Unit 1, Dippen, Brodick, Arran, Scotland, KA27 8RN. Tel: 077 082 234.



To: GTS  
 I would like to subscribe to PD NEWS for 6 issues (one year)

NAME.....

ADDRESS.....

CITY.....

POSTCODE.....

Please find enclosed payment of £4.99



### Which Software Can Do What?

**FORMS IN FLIGHT II** provides a range of sophisticated tools, many of which are not available in any other Amiga graphics package. It is a full 3D modelling and rendering system using up to 32 colours in lo-res. HAM is not supported.

The interface relies on a rather clumsy set of menus with no iconic controls. Objects are manipulated on a single screen that can view in any direction and are moved and rotated by movements of the mouse similar to, but much less sensitive than, those used by *Caligari*.

The lack of HAM and ray tracing plus the awful interface are almost made up for by the wonderful QSURF system which allows objects to be constructed by simple angular box sections. These can easily be smoothed and curved into some of the most organic shapes possible on the Amiga. Added to this is Phong shading (a smoothing algorithm that removes the faceted effect of the models), and texture mapping onto the surface patches.

Animation is possible but objects can only be moved along paths, not transformed. Nevertheless the ability to map different textures onto each patch means that objects with complex surface detail can be rotated convincingly.

**FORMS IN FLIGHT II**  
MicroMagic, £79.00

From Amiga Centre Scotland

**TURBO SILVER** is a 3D modelling, rendering and animation package with the most sophisticated set of surface mapping facilities in any program so far for the Amiga. It has been poorly marketed in Europe until now, but that is apparently set to change.

It has a good logical interface and the usual set of modelling tools (though a good deal of manual work moving individual points is required to produce subtle shapes other than pure extrude or spun).

Animation relies on 'paths' to move each object, but hierarchies can be set up and objects can be set to automatically rotate and/or align themselves with the path.

When rendering, each object (or face) can be any HAM colour and smoothed. It can also be a light source or a shaded object, matt or glossy, wrapped in an IFF picture or a coded texture with user definable parameters, or even fuzzy in the misty distance or sharp in close-up. If it is a light source and has an IFF

## TEXTURE MAPPING AND SURFACE PATCHES

**Forms In Flight II** will allow any 32 or 16 colour IFF picture to be mapped onto any surface patch (QSURF).

The Dolphin in this picture has all its surface colour provided by a simple drawing of the skin texture of a Spotted Dolphin.

The program is limited by its inability to use light sources so that rendered objects tend to look rather flat.

Nevertheless, the main picture wrapped onto a single patch illustrates that it is a 3D object.

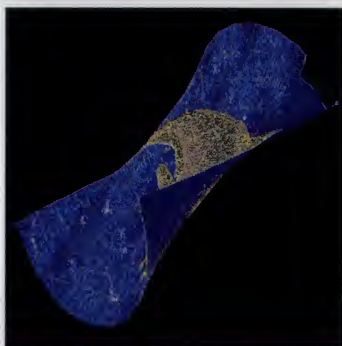
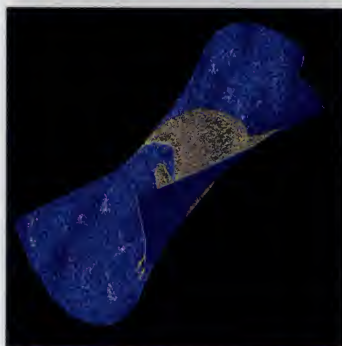

picture attached to it, the picture will be projected like a slide. Its orientation can be rotated around any axis.

Specular reflections can be controlled by varying their size and hardness. In effect this controls how shiny or matt the surface looks, distinguishing between rubber, glossy plastic, painted metal and other subtle variations. At present the 'plug-in' coded textures include: brick, check, grid, marble, wood, angular and disturb, but only the bricks and checks are available in Europe. (WHY WHY WHY?) These are illustrated to some degree

on these pages, together with some other examples of texture mapping.

The power of *Turbo Silver* speaks for itself via these pictures. A much fuller review of *Turbo Silver* and the Terrain Module which goes with it will be included with a tutorial on special effects in the next issue of *AF*.

**TURBO SILVER**  
Impulse, £119.95

From The Software Business

**PHOTON PAINT 2** is a 2D HAM paint and animation package. It includes extensive Surface Mapping tools and other special effects that can all be used to create excellent illusions of 3D objects.

Any flat brush can be wrapped onto a tube, cone, ball, ellipsoid, freehand shape, cube (all faces or each face) and the contour map described elsewhere. A light source can be set so that the wrapped object will have highlights and shading to enhance the 3D effect.

The ability to animate a series of *Photon Paint* frames means that objects can be moved about the screen, but the basic 2D nature of the program constrains this animation so that rotating texture mapped objects is very difficult.

**PHOTON PAINT 2**

MicroIllusions £89.99

From The Software Business

**SCULPT-ANIMATE 4D PROFESSIONAL** is probably the most powerful modelling, rendering and animation system available on the Amiga. It has a wide range of versatile modelling tools, an excellent interface, the fullest selection of rendering modes from wireframe to full ray-tracing, and a powerful range of animation tools (including a unique key-frame transformation system).

Nevertheless, with regard to texture effects it is the least powerful of the systems described here. Any facet can be any HAM colour and smoothing can be applied.

Dull, Shiny, Mirror, Luminous, Metal, and Glass surface textures are provided in a coded form so that they appear consistent from any view. There are no facilities for modifying any of them, and IFF brushes cannot be mapped. This is a great pity as it is the only weakness in an otherwise excellent system.

It seems unlikely that the situation will change because the developer of the *Sculpt* series, Eric Graham, has moved over to programming for the Mac. In spite of the lack of texture mapping and of control over the coded textures, some excellent effects can be achieved and these will be described in more detail in a future tutorial article on special effects.

**SCULPT-ANIMATE 4D PROFESSIONAL**  
Byte-By-Byte, £368

From Amiga Centre Scotland

To most people, importing their illustrations into a desktop publishing program can mean only one thing – bitmap graphics. If they need to plonk a picture onto the page, most people will reach for the old paint package and start daubing the pixels. Once complete, you save it out to disk, load your DTP program and pull it in.

It seems to look OK on screen, but what happens when you print out your document using a high-quality printer such as a laser or even a linotronic? You suffer from bitmapping. Even though your text may come out beautifully smooth, your graphics can look chunky and unprofessional. Surely there's a better solution than the old bitmap graphic?

### Object of Attention

The answer lies in structured graphics. Instead of representing the image as thousands of individual dots of colour, structured drawings organise the picture into basic structures based on geometric elements such as lines, curves, ellipses and rectangles. This produces a description of an image rather than the image itself, leaving it to the output device to draw the image from this description. Using this system, the only limit to picture resolution lies in the quality of the output device.

Another advantage of structured graphics is their flexibility. If you've ever picked up a brush within a pixel-based package such as *DPaint* and then enlarged it, you'll already know what happens – the brush becomes chunky. However, carry out a similar operation within a structured package and the image stays smooth and free from the dreaded pixel chunkies. Such operations aren't limited to simple resizing, either, as will be revealed later.

Although a pixel-based package may arguably be easier to use, the results that it can produce can never match those that are to be obtained from a structure-based package when it comes to printing the image to paper. As the Chinese say, 'A Picture tells a thousand words'. It's very important that your illustrations are of the best quality possible.

### Introducing ProDraw

Gold Disk are no strangers to the Amiga Desktop Publishing scene. Their DTP package *Professional Page* is undoubtedly the number one package of its type on the Amiga. To complement that product Gold Disk have now released *Professional Draw 2*, a powerful structured drawing package that could finally put the Amiga on the DTP map.

At first, using *ProDraw* is a little bit like using a pixel-based package. You can draw lines, circles and boxes just like you would in *DPaint*.

# DRAW FOR ALL



Gold Disk, leaders in Amiga desktop publishing for a number of years, also know about structured drawing. **JASON HOLBORN** draws some of his own conclusions about *Professional Draw 2*.

However, the difference with *ProDraw* is that the objects you draw aren't stuck where you first put them. You can easily pick up any object (regardless of how long ago you may have drawn it), move it around to your heart's delight and then plonk it down somewhere else. Even if the object obscured a large area, *ProDraw* will display what lay beneath the object before it was moved. It's almost as if images are layered – whenever you remove the top layer, the layers below are automatically displayed.

*ProDraw* provides a whole host of basic structured tools that you'd expect from such a package. As well as basic shapes such as boxes and circles, *ProDraw* includes the structured equivalent of the freehand draw tool. Once selected, you can use the

mouse to draw a complex object on the screen. As soon as you let go of the mouse button, *ProDraw* converts your squiggle into a structured object by converting it into a series of bezier (pronounced bez-ee-ay) curves.

Objects can be cloned (duplicated), grouped, locked in place and depth arranged with other overlapping objects. New to Version 2 of *ProDraw* is the 'Create Compound Object' option which allows you to create a 'donut'-like object (as the manual describes it). Put simply, this allows a object within another object to become transparent, therefore creating a hole the shape of the smaller object within the larger object. If you imagine the small object to be the shape of the hole in a donut, and the larger object to be the

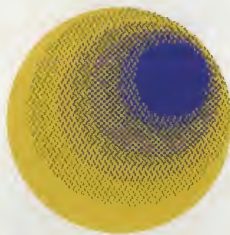

**RIGHT: Colour blending allows a great range of shading effects to be applied. The results can be breathtaking.**

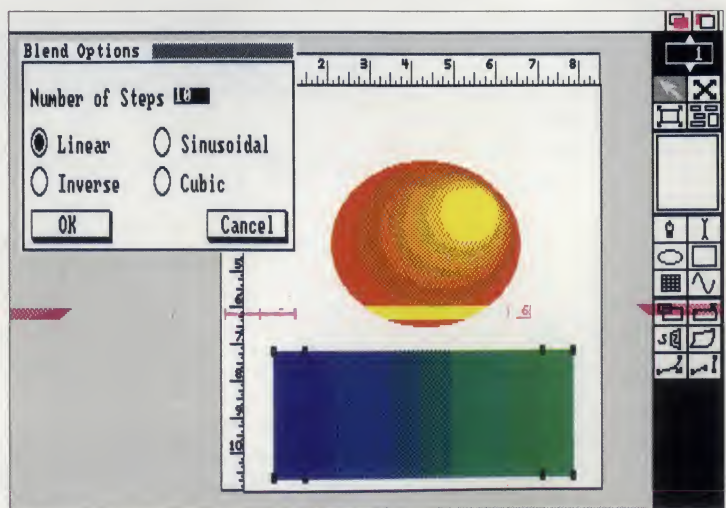

THE OXFORD  
SOFTWARES

# CHESS CHAMPION

2175

ATARI ST ■ AMIGA ■ PC

**POWER ■ STRENGTH ■ INTUITION ■ FLEXIBILITY**

- World's strongest chess play
- Infinite number of play levels
- Massive 300K opening library
- State-of-the-art graphics
- Variety of different piece sets
- Many easy levels for beginners
- Improved play with increased memory
- User friendly controls
- Intelligent – learns as it plays
- The only chess programme you need to buy

£29.95

European distribution by The Software Business

Brooklands, New Road, St. Ives, Huntingdon, Cambridgeshire PE17 4BG Telephone: (0480) 496497



# SNOWSTRIKE™

MISSION ZONE COLOMBIA-MISSION TARGET DRUGS!



.... U.S. CONGRESS IN EMERGENCY SESSION -  
MOTION TO DECLARE WAR ON COLOMBIAN  
DRUG BARONS NARROWLY DEFEATED ....

.... COVERT OPERATION PLANNED BY  
MILITARY. U.S. CARRIER SETS SAIL FOR GULF  
OF PANAMA.

.... DRUG BARONS READY TO SHIP THEIR  
LARGEST EVER CONSIGNMENT OF THE DEADLY  
COCAINE OR 'SNOW'.

.... DAWN. SQUADRON OF F14 JETS TAKE OFF  
FOR COLOMBIAN COAST. THE TIME FOR  
TALKING IS OVER - AND YOU WILL MAKE THE  
FIRST SOLO ATTACK!



Screen shots from ATARI ST version

**EPYX®**

© 1990 Epyx Inc. All rights reserved.  
EPYX is a registered trademark. No. 1195270.

Available on:  
CBM 64/128 & AMSTRAD Cassette & Disk  
SPECTRUM Cassette  
ATARI ST - AMIGA  
IBM PC & COMPATIBLES.

**U.S. GOLD®**

U.S. GOLD LTD, Units 2/3 Holford Way, Holford,  
Birmingham B6 7AX. Tel: 021 625 3388.

# THIRD COAST

UNIT 8 BRADLEY HALL TRADING  
ESTATE, STANDISH, WIGAN,  
WN60XQ TEL 0257 472444  
FAX 0257 426577

## XETEC

HIGH SPEED HARD DRIVE  
PERFORMANCE FOR YOUR  
A500 & A2000

## ICD

**FASTER THAN ANY OTHER "AMIGA COMPUTING"**



XETEC HARD DRIVES OFFER THE ULTIMATE IN TERMS OF PERFORMANCE FOR THE AMIGA A500.

**FASTER THAN ANY OTHER COMPETITOR**

TRANSFER RATES UP TO 800K/S

SUPPORT OF UPTO 9 MEGABYTES OF AUTO-CONFIGURING RAM

COMPACT HOST ADAPTER WITH 1 METRE CONNECTION CABLE

SUPPORTS TAPE BACKUP & NETWORKING UNDER SCSI

SUPIED WITH CACHE BUFFERING SOFTWARE

COMES COMPLETE WITH 40 MANAGEMENT UTILITIES & MANUAL

### XETEC A500 HARD DRIVES & RAM EXPANSION

XETEC 50 MEG 25 MILLI HEAD PARK £599.99	XETEC RAM £129.99
XETEC 65 MEG 25 MILLI HEAD PARK £699.99	1.5MB RAM £229.99
XETEC 85 MEG 25 MILLI HEAD PARK £799.99	2MB RAM £349.99
XETEC 106MEG 15 MILLI HEAD PARK £999.99	4MB RAM £499.99
XETEC 330 MEG 15 MILLI HEAD PARK £1999	8MB RAM £999.99

ADVANTAGE 2000 SCSI PERFORMANCE HARD DRIVE CONTROLLER. SUPPORTS TRANSFER RATES UP TO 900K/S. FULLY AUTOBOOTING SUPPORTING ALL EMBEDDED SCSI DRIVES & SCSI/ST506 CONTROLLERS

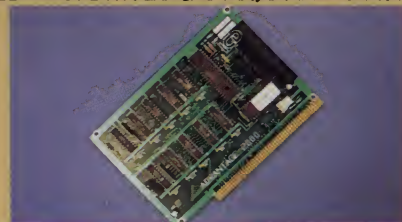

ADV CONTROLLER ALSO SUPPORTS OPTICAL DRIVES, TAPE STRAEMERS & REMOVABLE MEDIA DRIVES. CACHE BUFFERING & 20 NANOSECOND GAL LOGIC MAKE THIS THE FASTEST CONTROLLER COMMERCIALY AVAILABLE FOR THE AMIGA 2000 SERIES. PROGRAMMABLE MEMORY CACHE BUFFERING IS ALSO AVAILABLE. ADV WILL SUPPORT A DRIVE IN THE LANDING BAY OR ON THE SIDE OF THE CARD.

ADV 2000 PERFORMANCE SCSI CONTROLLER £129.99

ADV 22 MEG 25 MILLI AUTO HEAD PARK & LOCK £349.99

ADV 32 MEG 25 MILLI AUTO HEAD PARK & LOCK £399.99

ADV 50 MEG 25 MILLI AUTO HEAD PARK & LOCK £449.99

ADV 65 MEG 25 MILLI AUTO HEAD PARK & LOCK £549.99

ADV 85 MEG 25 MILLI AUTO HEAD PAK & LOCK £599.99

ADV 106 MEG 15 MILLI AUTO HEAD PARK & LOCK £699

ADV 330 MEG 15 MILLI AUTO HEAD PARK & LOCK £1999

ADV CONTROLLER & PC ST506 DRIVE CONTROLLER TO CONTROL ANY ST506 PC TYPE DRIVE £229.99

## IVS TRUMPCARD

## ALF



22MEG 25 MILLI AUTO PARK A500 £349.99

32MEG 25MILLI AUTO PARK A500 £399.99

50MEG 25 MILLI AUTO PARK A500 £449.99

106MEG 15 MILLI AUTO PARK A500 £799.99

META4 RAM 2 MEGS 80 NANOSECOND £299.99

META4 RAM 4 MEGS 4.5 ON A500 £499.99

TRUMPCARD WITHOUT DRIVE A500 £199.99

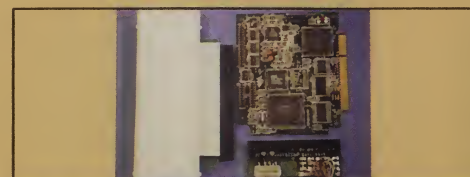

### ALF INTERFACE FEATURES

ALLOWS ST506 PC TYPE DRIVES TO BE ADDED ONTO THE A500. SUPPORTS TRANSFER RATES UP TO 600 K/S & WILL SUPPORT ANY PC TYPE DRIVE. COMPLETE WITH HOUSED COMPACT INTERFACE & LONG CONNECTION LEAD SUPPLIED ITH OVER 40 UTILITIES & COMPREHENSIVE MANUAL. ALSO AVAILABLE ALF KIT FOR AMIGA A2000

SUPPORTS ALL EMBEDDED SCSI HARD DRIVES

SUPPORTS UPTO 4 MEGS OF FAST RAM

AUTO-BOOT ROMS AS STANDARD USES FASTFILE

COMPACT DESIGN CLIPS INTO SIDE OF AMIGA A500

MEMORY EXPANDABLE IN 512K, 1MEG, 2MEG STEPS

2-3 TIMES FASTER THAN THE A590

UNIQUE DESIGN ALLOWS CONTROLLER & DRIVE TO BE USED WITH AMIGA A2000 SHOULD YOU EVER UPGRADE

### XT BOARD ACCELORATOR



£199

XT BRIDGE BOARD TURBO ACCELORATOR. INCREASES THE SPEED OF THE BOARD BY 50% ON ALL PROGRAMS.

ALF A500 COMPLETE KIT MFM £229 ALF A500 COMPLETE KIT RLL £249.99 ALF A2000 PC DRIVE KIT RLL £199 ALF A2000 PC DRIVE KIT MFM £199

# PERFORMANCE ENHANCEMENTS FOR THE AMIGA

## ACCELERATORS

## PRO-GENLOCKS



£299

16MHZ 68000 TURBO ACCELERATOR FOR THE A500 & A2000. OFFERS MINIMUM 95% SPEED INCREASE ACROSS THE BOARD ON ALL APPLICATIONS. FULLY COMPATIBLE & UNLIKE A 68020 A FRACTION OF THE COST.

HARD DRIVE UPGRADES FOR THE A590 OFFER 50% MORE SPEED & WHATEVER CAPACITY YOU REQUIRE.



A590 50MEG UPGRADE £299.  
A590 106MEG UPGRADE £599  
A590 1MEG UPGRADE £79.99  
A590 2MEG UPGRADE £147.99



£249.

PRO-GENLOCK OFFERING VIDEO IN & OUT. RGB & PAL OUR. BUILT IN FADER. EXTERNAL COLOUR & CONTRAST CONTROLS. SUPPLIED WITH A COMPREHENSIVE MANUAL & FEATURES THAT LEAVE THE RENDALE STANDING.

## RAM EXPANSIONS

A500 1M/BYTE RAM EXPANSION INCLUDING BATTERY BACKED CLOCK

£49.99

ICD ADVANTAGE RAM FOR THE A500 OFFERS ADAM (UNPOP) £99.99 MEMORY EXPANSION FROM 512K TO 1 MEG. THEN ADAM 512K POP £119 BY ADDING 4 CHIPS IT EXPANDS TO 1.5MEGS. BY ADAM 1MEG POP £159 ADDING FOUR MORE IT GOES TO 2.0MEGS. IT CAN ADAM 1.5MEG POP £199 THEN EXPAND TO 2.5,3.0,3.5,4.0 & 5.0 MEGABYTES. ADAM 2MEG POP £249 SUPPLIES WITHA COMPREHENSIVE MANUAL AND ADAM 2.5MEG POP £299 BATTERY BACKED CLOCK. IT TAKES ONLY 5 ADAM 3.5 MEG POP £399 MINUTES TO INSTALL & REQUIRES NO SOLDERING. ADAM 4.5 MEG POP £499 AVAILABLE IN ANY CONFIGURATION . PLUGS IN A501 EXPANSION SLOT UNDERNEATH A500. AUTO CONFIGURING!!!



EXP 8000 OFFERS UPTO 9 MEGS OF RAM EXPANSION FOR THE A500. IT USES STANDARD 1\*1 D-RAM & ALSO HAS A CO-PROCESSOR SLOT. FULLY AUTO-CONFIGURING REQUIRING NO SOLDERING.

EXP-8000 (UNPOPULATED NO RAM) £249.99  
EXP-8000 (2.5MEGS INSTALLED) £339.99  
EXP-8000 (4.5 MEGS INSTALLED) £499.99  
EXP-8000 (8.5MEGS INSTALLED) £899.99



ICD ADAM A2000 OFFERING SUPPORT OF UTO 8 MEGS FULLY AUTO-CONFIGURING RAM. UPGRADABLE IN STAGES 2,4,6 & 8 MEGABYTES USES STANDARD 1\*1 D-RAMS. SLOTS SIMPLY INTO ANY A2000 CARD. SUPPLIED WITH RAM CHECKER & MANUAL.

ADAM A2000 UNPOULATED (NO RAM) £149.99  
ADAM A2000 2 MEGS INSTALLED £299.99  
ADAM A2000 4 MEGS INSTALLED £449.99  
ADAM A2000 6 MEGS INSTALLED £699.99  
ADAM A2000 8 MEGS INSTALLED £899.99

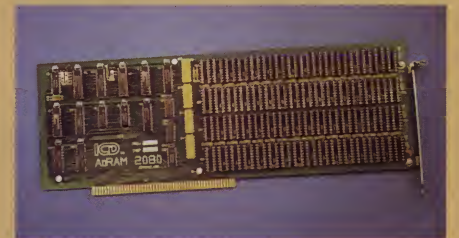

£149

X-PEGS 3D GLASSES. ALLOWING 3 D IMAGES ON YOUR A500. SUPPLIED WITH SOFTWARE TO MODIFY EXISTING GAMES & APPLICATIONS. A MUST FOR CAD & DIGITISING APPLICATION

HIGH QUALITY EXTERNAL FLOPPY 86 TRACK COUNT WITH PASS THROUGH & LONG CONNECTION LEED.



£59.99

INTERNAL 86TRACK 1MB FLOPPY. NO CASE MODS



£249

EUROTIZER FULL COLOUR DIGITIZER WITH BUILT IN RGB SPLITTER. SUPPLIED WITH SOFTWARE AND COMPATIBLE WITH DIGI-PAINT. NO MORE COLOUR WHEELS JUST THE BEST POSSIBLE RESULTS FROM CAMERA OR VIDEO RECORDER.

400 D.P.I HAND SCANNER OFFERING 1.5 INCHES X-TRA WIDTH OVER ANY OTHER SCANNER IN ITS CLASS SUPPLIED WITH MANUAL & SOFTWARE



£169



£99

IVS PRINTER INTERFACE ALLOWS CONNECTION OF A DIGITISER & PRINTER TO THE AMIGA AT THE SAME TIME ACTS ALSO LIKE BUFFER



£99

DIGITAL RGB SPLITTER ALLOWS IMAGES TO BE DIGITISED IN FULL COLOUR WITHOUT LOSS FROM A CAMERA OR RECORDER COMPATIBLE WITH ALL DIGITISERS

# THERE'S ONLY ONE

NOW AVAILABLE FOR  
ATARI ST & AMIGA

*Emlyn Hughes*



## INTERNATIONAL



*Audiogenic*



### OVER A YEAR IN THE CHARTS ...OVER 100,000 SOLD!

The 8-bit soccer game of the 80's becomes the 16-bit sensation of the 90's with the release of the long-awaited Atari ST and Amiga versions.

When EMLYN HUGHES INTERNATIONAL SOCCER was released for C64, Spectrum and Amstrad, reviewers were amazed. It rated 90% in ZZAP, 91% in Sinclair User, 88% in Games Machine, 91% in Amstrad Computer User, 94% in Computer & Video Games, 887 in ACE, Game of the Year in CCI - we could go on for ever!

Now, with the release of the Atari and Amiga versions reviewers are reaching for their dictionaries to find new superlatives. ZERO described the game as 'totally excellent', the sound as 'absolutely brilliant' 89%; Your Amiga rated it 'the best soccer simulation to date - 95%'; YC World Cup Winner 97%.

Forget the rest - there's only one EMLYN HUGHES INTERNATIONAL SOCCER!

AUDIOGENIC SOFTWARE LTD

Winchester House, Canning Rd, Wealdstone, Harrow, Middlesex HA3 7SJ. Tel: 081-861-1166.

MORE THAN A MATCH FOR THE BEST IN THE WORLD

# SCREENPLAY

## THE RATINGS EXPLAINED

### GRAPHICS

Good graphics are an important part of any game: if the power is there, it should be used to the full. Both static and moving graphics come under scrutiny in this rating, but remember, graphic wonders alone do not a great game make...

### SOUND

With stereo capabilities the last thing you want to hear are Spectrumsque beeps, right? Title tunes and effects all add to the atmosphere of a game and good sound can greatly increase your enjoyment.

### INTELLECT

How much real thought do you have to put in to play the game? Just because a game is mindless doesn't necessarily mean it's bad, but a game with a high intellect rating says immediately that you'll need to think to gain maximum enjoyment.

### ADDICTION

How easy is a game to pick up and play? How much sheer fun will you get from it? Will you keep coming back? Important questions, all answered by a quick look at the Addiction rating.

### OVERALL

A percentage mark that takes into account all the ratings, plus extras like lasting interest, documentation and packaging.

### THE TEAM

There are two main Amiga Format reviewers: Andy Smith is an ex-Spectrum owner who's been playing computer games for many years now and writing about them for almost as long, cutting his teeth on ACE before moving onto Amiga Format. Andy likes any type of game, from shoot-em-up to strategy game, from adventure to arcade conversion.

Maff joined AF after doing sterling service on ZZAP! 64. Recently he's been splitting his time between us and our sister mag ST Format, but after seeing the light has come out of the cupboard under the stairs and joined us full time. Maff's a solid all-rounder with a very nifty trigger finger and more than a match for most would-be high score challengers.

## KICK OFF TOO!

Get in on the action with Anco's sequel P.38

**Projectyle**  
Electronic Arts  
pucker up and score P.46

**Imperium**  
Galactic politics and  
megalomania P.50

**Turrican**  
Germanic destruction,  
causing a ruction? P.54

**Hero's Quest**  
Sierra make a man of you P.57

**International 3D Tennis**  
Palace ready to serve an ace? P.45



Playing as Italy against Austria on a plastic pitch you now have a corner and can decide on the direction and strength of the kick.



Fancy yourself as a fashion designer? Here you can pick the style and colour scheme of your fave team's kit - having them play all in pink can be a laff!

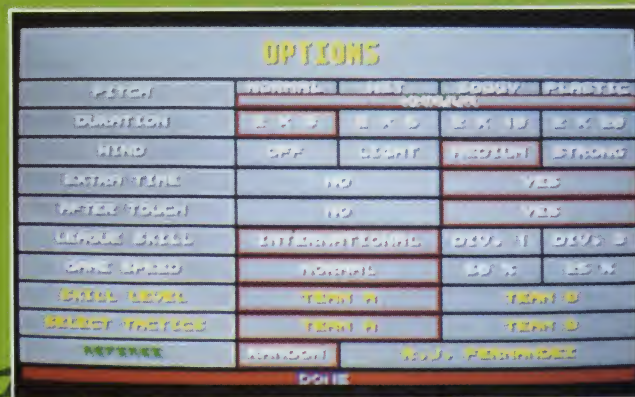

The options screen where you can alter any outside influences and decide game length, amongst a myriad of others.



The World Cup league table shows each team's positions within their group.



The second half - Austria are threatening with a free kick near the box.

# KICK OFF

**ANCO £19.95 ■ Joystick**

One year after an original that set the games-playing world alight, the much-anticipated and much talked-about sequel has made its appearance. *Kick Off 2* looks set to follow on from *Kick Off*, but with a host of new features to enhance the superb gameplay. Question is, has Dino Dini been too ambitious? Has he screwed up?

To start with, up to four players can play simultaneously (two players against two players). There's a league competition so loads of you can all compete together. There's a cup tournament, so you can knock your friends out and grab the glory, and there's also the World Cup tournament so you can persuade 23 other people to take a team each.

The gameplay enhancements include a new spotted ball, different match surfaces (including plas-

tic and soggy) the ability to change the team strip, the choice of long or short throw-ins and - possibly one of the biggest differences - the introduction of defence walls during free kicks.

There is also a new control touch added to the ball, called aftertouch. The player is now able to bend the ball slightly after it's been kicked by holding the joystick in a certain position, which can be very effective but does take a lot of practice.

The other main improvements include the ability to load in teams from *Player Manager* (the first real follow-up to *Kick Off*, for one player, which contained a whole management game) so you can play your lovingly-created team in the league against another team that someone else has spent blood, sweat, tears and lots of money building up. Now the player



**GRAPHICS AND SOUND**

Spot effects, such as the ball thuds and the crowd cheers, are excellent. The graphics are great too. The action is all viewed from above, which works very well for a game of this nature. The sprites are well defined and wonderfully animated and the pitch graphics are highly detailed including observations such as muddy areas in the goalmouth on soggy pitches and a squeaky-clean surface on plastic pitches. The graphics and sound mix together extremely well and compliment play brilliantly.

**LASTING INTEREST**

Well, Brian, this will run and run. It's perfect for 'booting up' (groan!) whenever you fancy either a quick 10 minutes or a good hour or three. In years to come this won't be sitting on your shelf collecting dust, because you'll still be playing it.

**JUDGEMENT**

If you don't own *Kick Off*, go for this instead. If you do already own it or own *Player Manager* it's still well worth considering. This is the best footy game to have appeared on any machine and the beauty of the game is the fact that it just plays so damn well. Novices will enjoy it right from the start and it's surprising just how skilful a player can become after just a few short weeks.

Last year, here at Future Publishing, *Kick Off* inspired us to start a league which grew into a four-division affair with 32 players taking part - even people who'd never played any game before! The league grew into a Cup tournament and hardly any work was done for months - the game actually became officially banned during working hours. Now there's talk of re-starting the whole thing again with *Kick Off 2*. You can't get a much higher recommendation than that.

<b>GRAPHICS</b>	<b>9</b>
<b>SOUND</b>	<b>6</b>
<b>INTELLECT</b>	<b>4</b>
<b>ADDICTION</b>	<b>9</b>
<b>OVERALL</b>	<b>94%</b>



# FF 2

can also have control over the strength and direction of corner and goal kicks.

The majority of play is much the same as before. Each team contains - of course - 11 players and the player you are controlling is highlighted by a line beneath his feet. As in *Player Manager* you have a choice between controlling the whole team, in which case control switches constantly to the player nearest the ball, or playing in one position.

Once you've gained possession of the ball your man automatically dribbles it and passes and shots are made by pressing the fire button and holding the joystick in various positions. Controlling your team takes a while to get used to, but practice really does make perfect and after a while your handling of the player improves significantly. **Andy Smith**



The Italians are getting heated and have given another free kick away. The Austrians float the ball into the box...



...the keeper has dived and missed the ball, the Austrians have a golden opportunity...



...as their striker nods the ball towards the other side of the goal...



... but, oooohh! How unlucky, the ball's hit the post and will be collected by the keeper. Italy breath a sigh of relief.

# A THOUSAND WAYS TO DIE...



More than 300 men have suffered terrible fates in pursuit of the untold wealth hidden in the Aztec Tomb of Quetzalcoatl. For 400 years no-one has dared to take up the toughest challenge man has ever known, despite the promise of riches beyond imagination. The ancient Mexican treasures are protected by the most evil forces in an underground world of hostile creatures and traps.

Your name is Bret Conrad, and you're not like other men. Your Special Forces training and Vietnam combat duty have made danger a way of life. But this time the odds really are stacked against you. If you succeed in stealing the greatest undiscovered treasure of them all, it'll be a miracle. But be realistic - in the Land of the Aztecs, gold is the passion .... but death is the probability!

## ...BUT ONLY ONE WAY TO STEAL...

AVAILABLE  
ON  
ATARI ST

•  
AMIGA

•  
IBM PC &  
COMPATIBLES



U.S. Gold Ltd, Units 2/3 Holford Way,  
Holford, Birmingham B6 7AX.  
Tel: 021 625 3388.

# THE Gold

## OF THE AZTECS

### VISIT THE LAND OF THE AZTECS!

We think this game is one of the toughest action adventures ever devised. That's why we're giving away the trip of a lifetime to visit the Land of the Aztecs in Mexico next Summer.

To win you have to beat all-comers in

### THE GREAT AZTEC GOLD RUN!

SEE BOX REVERSE FOR DETAILS





Before starting each wave you're left in no doubt as to what you're supposed to be doing.

Frankly, it comes as a nice change to play a game in which you don't have to save the world from aliens, run about kicking seven shades out of baddies, or race round a maze collecting keys or pieces of puzzles. In *Klax* the only objective is to survive as long as possible and score points.

The game is very easy to play. A horizontal platform five lanes wide sits pointing towards you. Coloured tiles start at the end furthest away from you and roll towards you. There are five bins at the near end of the platform that the tiles fall into. Each bin holds five tiles, but should all the bins fill up then you lose a life.

How do you stop them filling up? You can't really, but you can buy yourself time by using a small tile catcher at the end of the platform, which you can move left and right to catch tiles as they fall off. Then you can decide which tiles to drop in which bin by hitting a key and flipping them off the catcher into the bin. And here's the key to winning the game - any line of three or more tiles of the same colour, either vertically, horizontally or diagonally, makes a Klax. The Klaxed tiles then disappear, leaving more room for more tiles in the bin.

The game is played in waves, with a specific objective given for each wave. For example, you may just have to get three Klaxes, or maybe three diagonal Klaxes, or score 10,000 points. The points system is based on difficulty. Anyone can get a vertical Klax, so you only get 50 points for each one. Horizontal Klaxes are harder, so score 1,000, while diagonal ones are harder still and score even more points. Once a wave is completed points are awarded and you move onto the next wave.

That's basically it. Oh yes, the catcher at the end can hold up to five tiles at any one time, so you can organise Klaxes slightly more easily and you can also flip a tile



Errm... the catcher is completely full, and there's no where to drop them and ...help!



A Klax will be created when you tip off the white tiles from the paddle onto the white one in the bin.

# KLAX

DOMARK £14.99 ■ Joystick or Keyboard



In simultaneous two player mode where things can get very confusing (and heated!).

back half-way back up the platform to gain yourself a couple of seconds while you go for another tile. Any tile that falls off the end uncollected by the catcher scores one on the drop meter - once you've filled that up you lose a life. Plus, of course, the tiles speed up and more colours appear as you progress through the levels, making it even harder to get the particular Klax you're after. **Andy Smith**

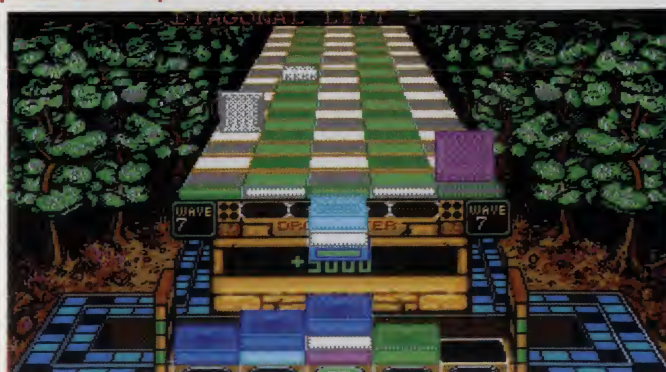

The next wave. That blue diagonal earns a massive 5,000 points.

## GRAPHICS AND SOUND

The sound effects are nothing to shout about, but at least you know when your catcher is full and when you've made a Klax. The graphics are nothing special either, though the diminishing perspective is quite pleasing. The viewing angle does make it a little difficult to tell when a bin is full, for example, but the thudding sound effect lets you know if you try to put more tiles in it.

## LASTING INTEREST

A game to last for years. It's a 'quick 10 minutes' when you feel like it and it's also a 'good three hour session' when you've got time. A timeless game that you'll come back to again and again.

## JUDGEMENT

Look at that! Right the way through the review and not a mention of *Tetris*! Comparisons have to be made simply because they are both very simple space-filling games that play remarkably well. *Tetris* is a slightly better game, but *Klax* gives it a damn good run for its money and it really should be in your library.

GRAPHICS	6
SOUND	6
INTELLECT	7
ADDICTION	9
OVERALL	88%



Things start to get hot, as fire arrows reign in on Level Two.

# DYNASTY WARS

US GOLD £19.99 ■ Joystick

China in 184 AD. A group of soldiers murder wave after wave of weaker opponents. In response, the remnants of the Han clan lead this horizontally-scrolling quest for revenge through ancient China, splatting anything in sight.

The horseback heroes can either fire fast, stabbing short-range shots or store them up into one massively mean megablast.

The evil General's minions aren't tough; one quick poke in the head and they're history. Save up a big shot, by holding the fire button down, and a single blast can bag three at once. The end-of-level Generals are a different kettle of foe, though. They've mounts, decent armour and extremely large weapons. They'd pose no real problem if you could face them one on one, but they pop up when the screen's already undergone a population explosion.

This is where the Dynasty Warriors play their trump card – tactics! Rather like a medieval air strike, with rocks or fireballs instead of Napalm, magic cleanses the area. Tactics kill all

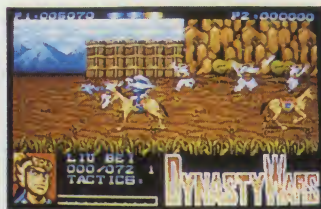

An evil general gets wicked at the expense of Liu Beh.



Don't mess with Shang Fei, especially on bridges!

normal folk and weaken the Generals, but leave you unharmed.

The four Han clan warriors who are on offer vary in ability, with the amount of damage they can take balanced inversely with the amount they dish out. A real big hitter is needed to waste the Generals, but a durable weak-weaponed guy has the advantage

of surviving long enough to actually meet them. And of course famous warriors like these can't wander round with a wimp's weapon all their lives, so en route there are more powerful blades to collect and keep, as well as extra hit points which help to cure any warrior who is careless enough to get sliced. **Trenton Webb**

## GRAPHICS AND SOUND

The introductory screens create an atmosphere of legend and these pictures are echoed on the playing screen with animated faces that contort in anger and pain, but this level of detail isn't carried into the battle. The backgrounds are excellent, but the playing area is too small to cram in the detail, especially at the end-of-level showdown: there are so many people on screen it's hard to know who you're killing. All very realistic, but not helpful.

Annoyingly, the music plays throughout the game. Not that the music is bad - it's atmospheric, if a tad up-tempo. The irritant is simply the fact that there are no sound effects. All the obvious opportunities for blood-curdling martial arts battle cries and the crisp swish of blades have been missed, which is sad.

## LASTING INTEREST

*Dynasty Wars'* core problem is that there isn't an awful lot to do! With only two modes of attack you either have to use spear power to spike enemies or call in magical tactics. And with only tiny guys on horseback to look at – some of whom apparently ride side saddle! – there's not much to keep you rivetted to the screen. The similarity of foes too, makes the game easy, with the higher levels reachable in the first few attempts. The war, it seems, will definitely be over before Christmas, maybe even August!

In spite these factors and the deliberately slow pace *Dynasty Wars* has an undefinable charm. There's a sense of tension, while the sheer number of opponents makes life awkward. The levels, while similar in concept, are very different in design, ranging from burning bridges to snow-swept wastes. It's worth getting to each new level just to have a look at the scenery.



The killer snowballs perpetrate an attack on Level Four.

## JUDGEMENT

A reasonable chop-em-up which has the distinction of horse-riding heroes, enough original elements and is bound together with a certain slick style. Once it's finished – which shouldn't take long – it's unlikely you'll ever play *Dynasty Wars* again. But while you're still trying to top the big nasty who ruined the Han Clan, *Dynasty Wars* should prove an enjoyable diversion.

GRAPHICS	8
SOUND	5
INTELLECT	2
ADDICTION	6
OVERALL	69%

CLASSIC GAMES  
FROM SYSTEM 3

*Now Available on Amiga, Atari ST and MS-DOS*

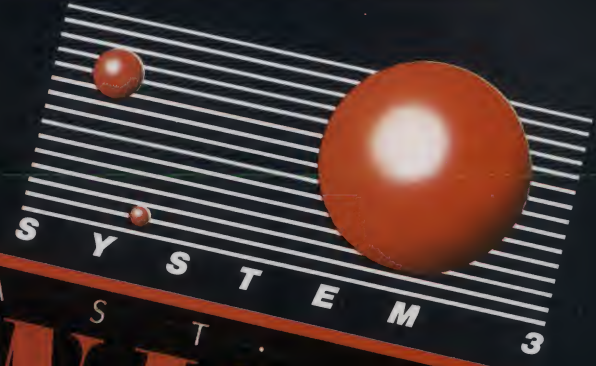

LAST

# NINJA

BACK WITH A VENGEANCE

SYSTEM 3



# BACK WITH A VENGEANCE



Mail Order: Intermediates Ltd., P.O. Box 847, Harlow CM21 9PH Tel: 0279 600197  
Consumer/Technical Enquiries: 081 866 5692

COMING SOON...

# BACK TO THE FUTURE II

PART II





Serving is automatic on the easier levels, so at least you're not going to give games away double faulting.

# INTERNATIONAL 3D TENNIS

**PALACE £24.99 ■ Joystick**

Just as art can occasionally attempt to imitate life, so computer games programmers attempt to do the same thing, but usually with very differing results. One of the biggest hurdles the programmers have to jump is getting human-like figures into games and then getting them to move with human smoothness and fluidity. That's why Palace and Sensible Software have spent nine months developing this 3D tennis game.

There are three distinct sections to the game: single match, Tournament and Season. The single match is obvious enough; you play against either a friend or the computer for a defined number of sets. The Tournament is slightly more complicated, in that there are 72 tournaments to pick from, each with a different amount of prize money to be won, and again the number of sets can be defined. Then there's the Season, which allows you to make a living by playing in various tournaments

throughout the year.

There are several skill levels, but the one you'll want to get some practice in on is the 'Amateur' level. Here the computer takes serves for you, moves your character around the court to get him in the best position to return the ball and then flashes your character to inform you that he's in range to return a shot. You can influence things slightly by moving your man closer to or further away from the net if you wish and also by holding the joystick in any one of nine positions after you've made a hit, which will influence the direction of your return.

Step up a skill level and you can then start directing serves, but you still get the flashing. Go up another skill level and the flashing disappears. Go to the top level ('Ace') and you can then start adding spin (top and back) to the ball by hitting the firebutton again and moving the joystick forwards or backwards. **Andy Smith**

## GRAPHICS AND SOUND

The sound effects, including a digitised score keeper and umpire, are excellent, giving real atmosphere to the game - atmosphere which the graphics unfortunately take away. The programmers have substituted reality for triangular racquets and triangular players in the search for speed and fluid movement. This works to some degree. If you don't like the viewing angle of the matches you have a choice of nine others and there's even one that allows you to position the camera just where you want it



A long distance view of the game.



It's not all lawn stuff, here you're on cement.

## LASTING INTEREST

The graduation of skill levels has been well judged and although it still takes a while to get to grips with amateur level, once you have you'll be wanting more control so can step up a level (the computer players get better as you step up the levels too). One to keep you coming back whenever you fancy a game.

## JUDGEMENT

It's got some hot competition from the likes of Ubi Soft's *Pro Tennis Tour* which, it has to be

said, is altogether a better game. *International 3D Tennis* is good, but the graphics let it down and, although it plays well, it doesn't play as well as Ubi Soft's game. A nice attempt but not good enough to steal *Pro Tennis Tour's* crown.

GRAPHICS	5
SOUND	8
INTELLECT	5
ADDICTION	7
OVERALL	79%



Your races across to return a shot. Inset: next stop Auckland.



The Vector player has made a mistake and put the projectile into his own goal in the Frantic Zone (this is a regular occurrence for all teams!) The last opposing team to touch the projectile will be credited with the goal.

PROJECTYLE LEAGUE TABLE

TRIBE	P	W	D	L	F	A	PTS
ELDRITCH CATS	004	004	000	000	0053	0031	032
JOVIAN JELLO JUGGERNAUTS	003	002	000	001	0031	0017	020
DEVILS	003	001	000	002	0022	0024	016
MANIC MOOSE	004	000	001	003	0023	0032	014
SLEDGE HAMMERS	003	001	000	002	0023	0024	010
UZTERS	004	000	000	004	0025	0040	006
VECTORS	003	000	001	002	0015	0025	006
TERMINATORS	003	000	000	003	0015	0030	004

After every match the league table is updated. After three matches the Terminators are bottom of the league, so it must be time to stop messing around and start playing!

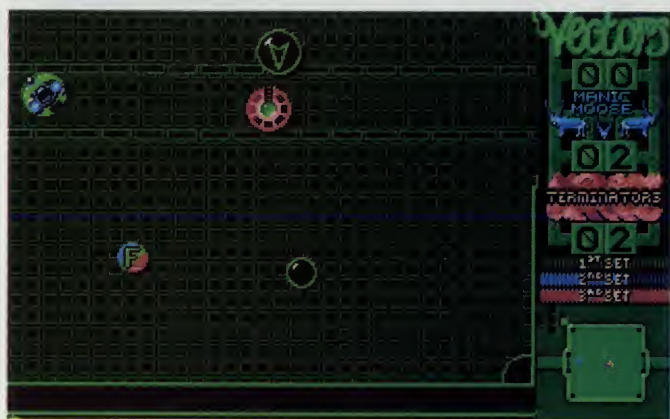

Collecting that 'F' symbol would be a good idea as it instantly freezes the other two players for 10 seconds which is plenty enough time for a skilled Projectyle player to get the thing away from his tunnel entrance and into one of the oppositions'. If someone gets there before you, though, you're in big trouble!



ABOVE: If the blue (Manic Moose) player can get to the 'DOSH' symbol he'll be able to spend the money on improving his team's statistics. BELOW: Kick-off at home to the Vectors. You start the game defending the goal on the right. Next set you'll defend the left and then the top. This also applies to goals in the Frantic Zone.

Most ball games are complicated enough. Football, basketball, hockey and the rest all have their own peculiar rules which can have even an aficionado scratching his head at times. And these games are all played on one single pitch – just imagine what a game that was played on five pitches would be like!

This game of three players, three halves and five square pitches is surprisingly simple: eight teams, each of eight players, make up a league. One, two or three human players take control of a team each and during a match attempt to score goals in either of the two opponents' goals. The team with the most goals at the end of the three periods wins.

The five pitches are all linked by tunnels, through which no players can pass. The centre pitch is where the kick-off takes place and on each wall there is a tunnel entrance leading to another pitch. Three of the four entrances are colour-coded to show that the pitch on the other side contains a goal belonging to the team with that colour. Send the ball – or projectile as it's known in the game – through the tunnel and it emerges onto another pitch that has that team's goal on the opposite wall.

The tunnel on the fourth wall however, which is the one always at the bottom, leads somewhere a bit special – the Frantic Zone. On

this pitch there are three goals, one for each team.

The rules of the game are terribly easy – anything goes! This means you can bump, bash and smash into the opposition as often as you like in your attempt to get to the ball and knock it around to keep it out of your pitch, then get it onto an opponent's where there's a goal.

Once a goal is scored the scoring team is credited and play begins again from the centre pitch (if an own goal is scored – which happens very often, especially in the Frantic Zone – the opposing player who touched the ball last is credited with the goal.

The match then continues in this fashion until the end of a set, at which point all the teams move one place to the right.

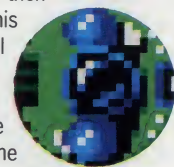

Suppose your goal was on the top pitch for the first set: once the second set starts, your goal will be on the right-hand pitch. No-one ever gets the bottom pitch because that's always the Frantic Zone. After three sets (about six minutes of real time) the match is over, the scores are logged and the points are dished out.

The players each have peculiar attributes and all remain in the same pitch that they start the

With training mode selected the player is given the opportunity to improve his side by spending money collected during the game.

TRAIN YOUR TRIBE

AMOROS	LEMANO	CICISBEG	ARGENT
Attack 1	Attack 1	Defend	Attack 2
Power: 44	Power: 45	Power: 54	Power: 51
Slide: 24	Slide: 25	Slide: 40	Slide: 31
Being: 40	Being: 39	Being: 46	Being: 34
Wear: 5	Wear: 4	Wear: 24	Wear: 72
Nour: 46	Nour: 4	Nour: 14	Nour: 51

THE TERMINATORS

NAME: EPRISE  
ZONE: CENTRE  
AGE: 42 SEX: M  
BORN: 20th, Jan, 2959  
PLAYED: 99 GOALS: 99

CREDITS REMAINING: 100

QUALITY	+	COST
Power	57 +	10
Slide	25 +	08
Being	52 +	05
Wear	75 +	02
Nour	51 +	07
Injury	00% -	00

DEPLOY SELECT



The first match of the season, away to the Jovian Jello Juggernauts and the Devils. The Juggers are the purple guys nearest the Projectyle and you're the pink guy near the extra stamina benefit.

# PROJECTYLE



Electronic Arts £24.99 Joystick



game in, so it's well worth checking out their stats before deciding where they should play – a fast chap on the start pitch is a must.

Before a match the players can be trained, and their attributes increased: however, not only do they then run the risk of injury but training costs money and the only way to get any money is to pick up the dosh symbols that appear on the pitch at random. These benefits appear regularly throughout the match on all the

pitches and can be collected by the first player to slide over them. The money can be used to finance your training program while all the other benefits – such as 'freeze opponents' or 'block exits' – only last on the pitch they were picked up on and only for a maximum of 10 seconds.

The closest the gameplay comes to a game in the real world is ice hockey. The players slide all over the shop in pursuit of the projectyle (your players automatically turn to face the ball wherever it moves) and you're able to move the player using the joystick with the fire button acting as the accelerator. **Andy Smith**

GRAPHICS	9
SOUND	7
INTELLECT	5
ADDICTION	8
OVERALL	90%



Away to the Devils and it's a tense moment as the projectyle leaves the start pitch and goes through the tunnel towards your goal pitch.

## GRAPHICS AND SOUND

The perspective, viewing from directly above, works very well and everything is smoothly animated. The effects are fine and so is the music – and you can toggle between the two at will. Games are played on different pitches belonging to different teams, which makes a welcome change during the game not only from the aesthetic viewpoint, but also because the different playing surfaces change the way the game's played. Looks great.

## LASTING INTEREST

Bags of it. The shortest league season requires you to play 18 matches, so get ready for some long playing sessions. The multi-player option and multiple skill levels mean you won't burn this out for a very considerable while: and fortunately there's always the save game option to fall back on.

## JUDGEMENT

The action is fast and furious – especially with a couple of friends – and though at first it seems as if too much of the gameplay is left to luck, a few hours of play will convince you that it is in fact very skilful. You need to use some sound tactics to beat the better of the computer-controlled teams. Cracking stuff that can be as exciting as *Kick Off* when you've got a few mates round.

## A GAME OF THREE HALVES...

### START PITCH.

The game re-starts here after every goal and at the beginning of each set

### TEAM PLAYERS.

One player per pitch; the players are unable to move through the tunnels

### GOAL MOUTHS.

One per pitch (except in the Frantic Zone)

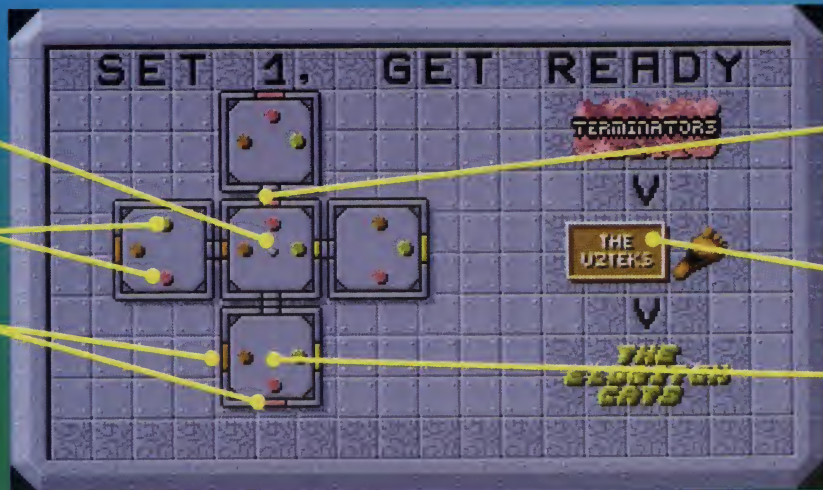

### CONNECTING TUNNELS

Join all the pitches together. Only the projectyle is allowed to pass through

### TEAM EMBLEMS

Show who's playing who. The top emblem indicates the match will be played on their home pitch

### THE FRANTIC ZONE

in which all three teams have a goal-mouth to protect



Snakes and bats attack our muscle-bound hero under a thunderous sky.



Don't miss the lift, but watch out for those deadly rising bubbles.

### GRAPHICS AND SOUND

*The Plague* has some extremely nice graphics, with well drawn and colourful backgrounds scrolling smoothly behind the impressively sized sprites – the animation could have been a touch more interesting, though. The real problem is the sound. The music sounds thin and incredibly dated and the sound effects are just too weak to be true. The powerful image invoked by the graphics is completely lost when the game is played with the volume on anything but 'off'.



Oh, look! How nice! Someone is keeping their eye out for you!

# THE PLAGUE

SOFTWARE BUSINESS £19.99 ■ Joystick

As Earth wars become more and more dangerous, costing the lives of an incredible number of people, scientists begin research into the development of 'enhanced' animal species capable of surviving nuclear attacks, thus eliminating the fear imposed by enemy warheads.

Research has been going well for a number of years – so well, in fact, that nuclear war has been discarded altogether and the governments are returning to traditional (and arguably less devastating) battlefield combat.

Unfortunately, as is the way with genetic experimentation, a biological demon has been found in our midst. Within the genetic breeding ground a deadly plague has broken out. The virus spreads quickly, affecting the bodies and minds of all its victims.

Once peaceful 'super-humans' have been transformed into evil, mutated warriors, hell-bent on causing death and destruction across the scientific complex. Some of the scientists are trapped within the complex, suffering from early symptoms of the disease.

You play a mighty soldier, your body adapted by laser surgery to protect you from the virulent



Megadeath-dealing caterpillar on the loose! Where's the 'Raid'?



Launch that beam skywards and take out those jet-pack flyers.

illness. Armed with the latest laser weaponry you must infiltrate the now-ruined complex and wipe out the mutants, rescuing any survivors who may yet still be saved by precision surgery. At the beginning of the game you are armed

with a laser rifle that can be powered to release a dangerous 'mega-blast' beam, destroying all in its path. Attackers may swoop in from all directions, however, so picking up extra weapons may come in useful for picking off jet-attackers and the more heavily armoured amongst the foe.

At the end of each stage is a grotesquely mutated being that will soak up a number of shots before it explodes, allowing you to gain access into the deeper regions where the effects of the plague are even more apparent. Just remember – they were all human once! **Maff Evans**

### LASTING INTEREST

The levels themselves aren't really that difficult to master. All that has to be learnt to romp straight through is the order in which the aliens appear. The difficulty starts when the end-of-level gaurdian is reached. A combination of vibrating trigger finger, luck and telepathy is needed to judge the timing of jumping and ducking while still piling the shots in. After dying a dozen times at the hands of the same alien, frustration and broken joysticks are a formality.

### JUDGEMENT

Despite the nice appearance, *The Plague* is nothing more than a run-jump-blast shoot-em-up in the mould of many arcade games circa 1985. Very little has been done to bring the game up to the level of gameplay expected in the Nineties.

GRAPHICS	8
SOUND	4
INTELLECT	2
ADDICTION	4
OVERALL	61%



ATARI®...THE POWER BEHIND



# THE POWER OF TIME & SPACE



JEFF MINTER'S  
**PHOTON STORM**

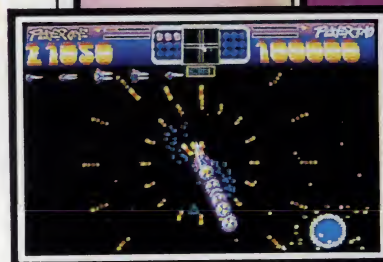
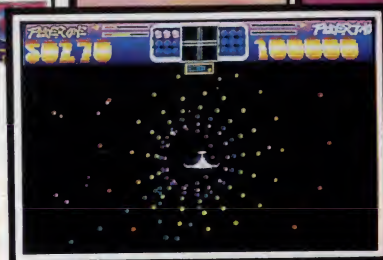

### PHOTON STORM

A classic space shoot-em-up from the master of addictive arcade classics - action, colour, excitement and mind boggling destruction make Photon Storm the definitive example of manic alien encounter. Patrolling outer space a desperate command suddenly orders you on a mission to seek an alien Battlestar, menacingly forming in a remote universe. Quickly you turn to your scanner and head-up display, desperate to locate the Stargates that will allow you to enter the time warp zones and speed across the galaxies. Instantaneously your attention is drawn to your lazer systems - their awesome power is immediately required - the Battlestar has released fleets of space fighters to halt your progress and return with the plutonium vital to its progress. If your skill lets you down or your nerve fails you in your encounter with the collisions, minetraps and fireballs released by the alien fighters, the Battlestar will grow in strength, activate and unleash hordes of reeking Ferrets that will not only bring to an end your mission, but the future of mankind as well. On with the navigator, out with the blasters and give those homicidal, psychopathic aliens pure hell!!

ATARI ST · AMIGA



Screen shots from various systems.



REACH OUT FOR THE POWER OF ARC  
ATARI ST · CBM · AMIGA · IBM P.C.

ARC P.O. Box 555, Slough SL2 5BZ.

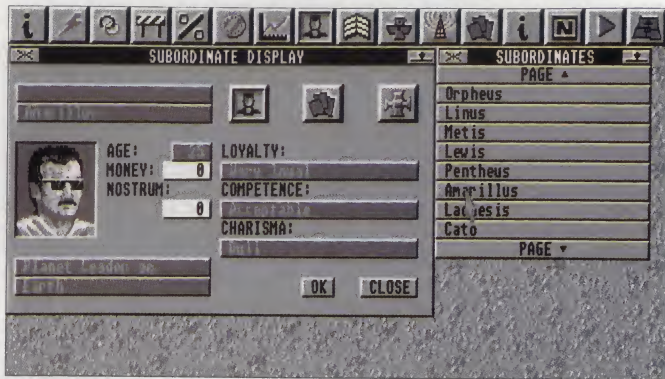

There's a large number of subordinates you can call on to run newly-conquered planets, or to head space fleets, but picking the right man for the job requires some thought.

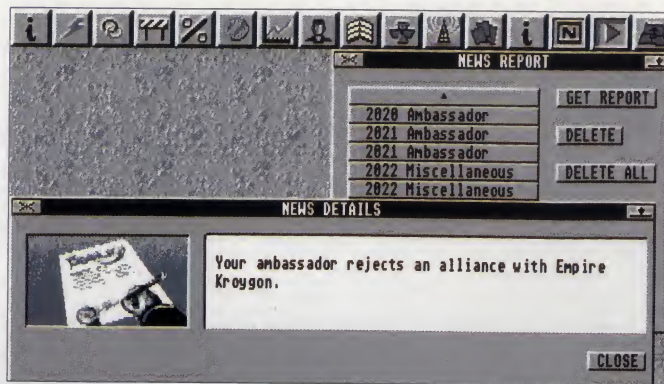

News reports come in at the start of each turn and by reading these you can catch up on galactic events and discover if any of the aliens are becoming a bit too ambitious.

For some of us, owning the world is just not enough. What we want is the whole galaxy. Fortunately for the rest of the galaxy, none of us will ever be able to achieve our ambition for real so we have to content ourselves with computer simulations.

*Imperium* is one such simulation, allowing a player to take command of an imaginary galactic power based on a planet called Earth (now there's someone using their imagination!) and, by skilful use of diplomacy, economics and military might, conquer and populate a small galaxy containing around 30 star systems.

Then again, if you're the more passive type and don't go in for this glory lark you can always try to win by just keeping your empire going and survive as leader for 1,000 years. How long! Yup, 1,000 years. Achieving that, though, will still require careful juggling of your empire and skilful manipulation of the other galactic inhabitants – the aliens.

Several other computer-controlled empires are also trying to expand their horizons and do much the same as you (though they're much more into conquering things rather than keeping their tentacles to themselves).

The game is completely menu-controlled, so all your decisions are made by selecting icons at the top of the screen which cause menus to appear. Then you can make decisions on what to do from the menus. The game is played in yearly cycles (the number of years being user defined), then once you've done enough for one year you simply click on 'next turn' and the game advances.

So what keeps you playing? Why not just skip a number of years and outlast the game? For a start, no-one lives for 1,000 years without taking steady quantities of the life-preserving drug Nostrum. Nostrum can be found throughout the galaxy and can be refined from the planets on which it occurs.

Taken in moderate doses it enables you and your subordinates to remain alive for a lot longer.

Of course, you first have to find the stuff, so you have to start thinking about moving beyond your own star system. And this is where you come to the crux of the game – economics. Money has to be generated through developing your planets, producing commodities (over 20 of them) which you can use to build ships or use to trade with the aliens. You can also buy things you can't produce from the aliens and to make things interesting you can set import and export taxes, put trade embargoes on certain items and all manner of other things.

Colonising other planets not only expands your empire, but also makes you popular with the electorate who go to the polls every 50 years to decide on the next leader (if it's not you, then it's game over). And as all good politicians know, money talks. A good deal of cash has to be stored as the years go past which can be called upon when you come to campaign for re-election.

There are loads of planets to discover and dealing with the aliens can be a very tricky business. Keep things ticking over, let the computer handle the economics and/or the diplomacy to start with while you concentrate on the military side of things until you become familiar with the game and gradually start taking things over yourself once you understand just how different things affect the game.

Don't be afraid to experiment, push taxes way up and see how it affects things, start censoring the press and see how it affects your popularity. Play around and after a few games you may find you have just the sort of qualities a galactic leader needs. You may even start calling yourself Emperor Ming... **Andy 'Not tonight Josephine, I've got an empire to run' Smith**

# IMPER

ELECTRONIC ARTS £24.99 ■

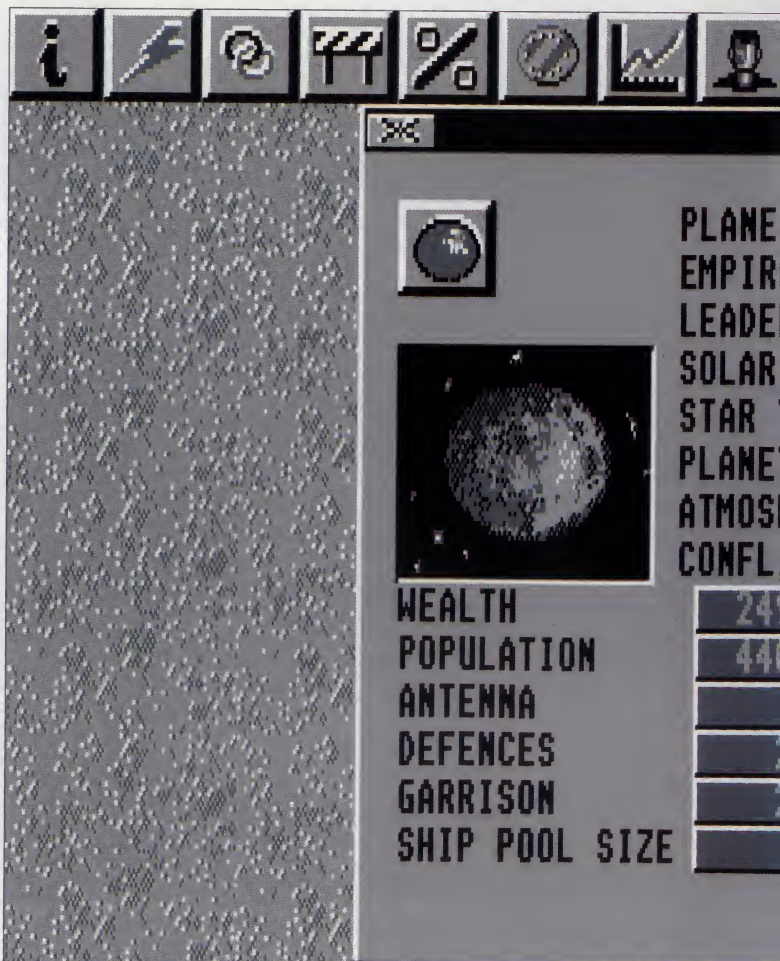

The planet menu gives you a whole list of statistics for each planet. You can decide whether to help the planet or start creaming off some of its wealth.

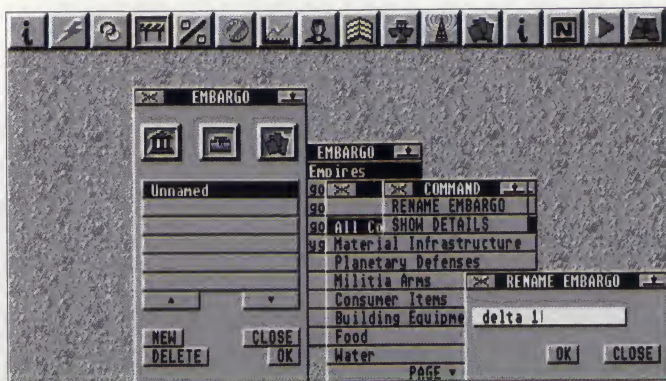

As you can see, doing a simple thing like placing a trade embargo on all commodities to aliens can become quite a complicated matter. Thankfully the system works much easier than the picture suggests.

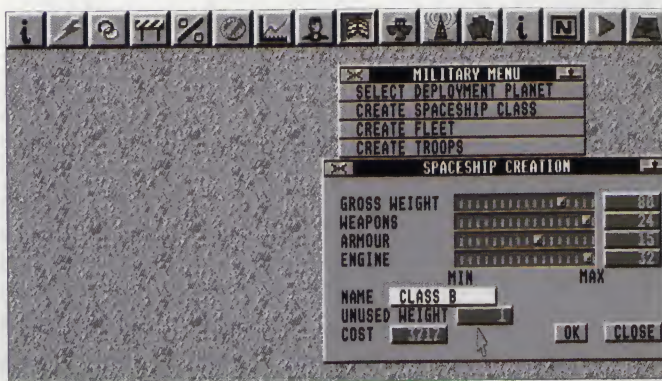

When you've got some money together it's time to start thinking about building up a fleet. Up to 20 spacecraft can be designed. The one above is a heavy attack craft.

# IUM

## Mouse

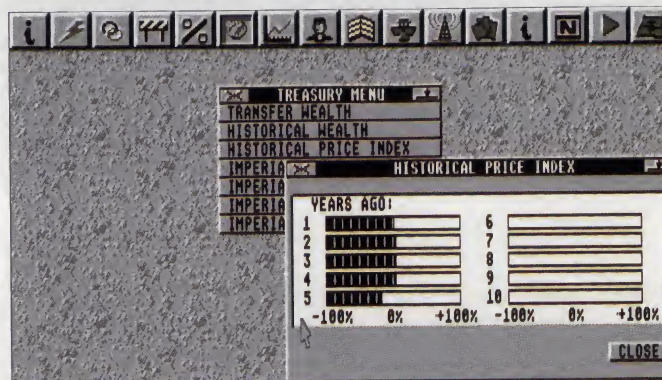
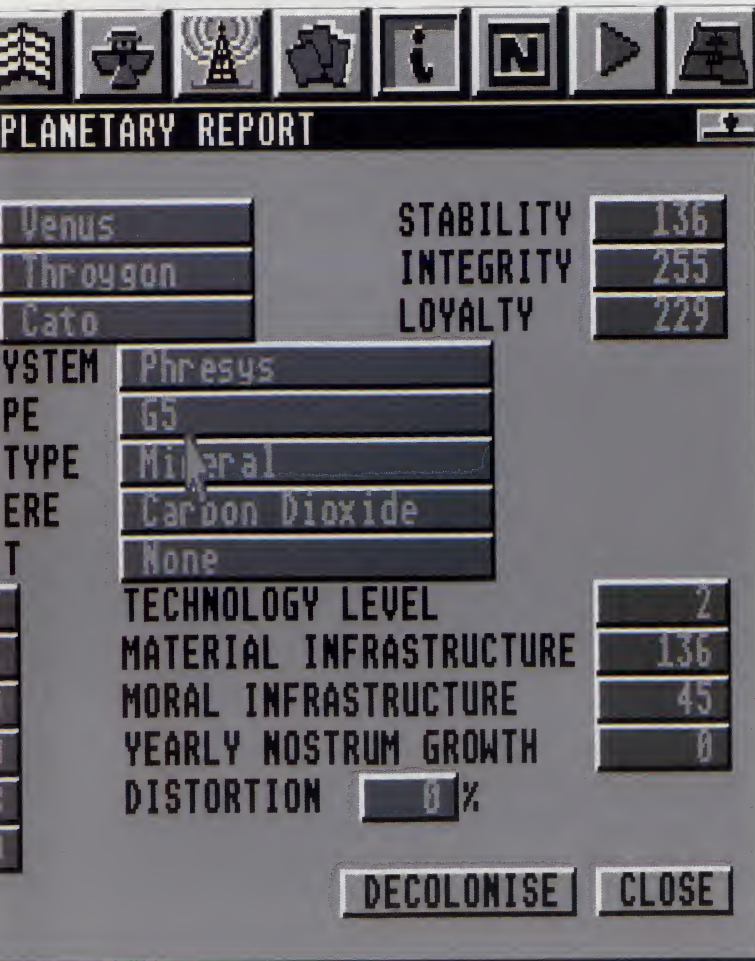

A quick look at how the economy has been going for the last few years gives a good indication of how sound your economic policies have been.

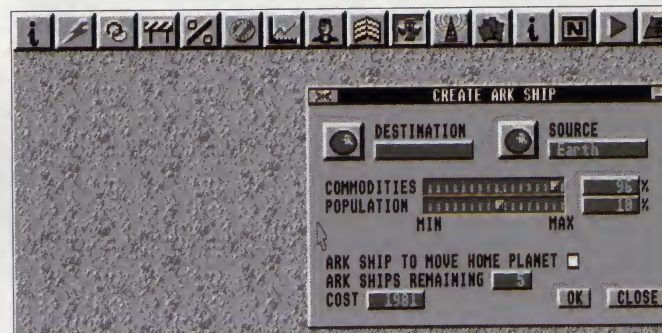

Ark Ships are used to shift people to a new planet and get it running for you. Evolution? Who needs it?

## GRAPHICS AND SOUND

There are a few sound effects, usually short bursts of music, which are fine but not special. The graphics of the game are also quite reasonable. Bear in mind that this is not meant to be a graphic stunner; it's a thinking person's game. That said, all the menus are nicely presented and are very clear.

## LASTING INTEREST

This is the game's strong point. It takes a long while to play a single game and it also requires a lot of concentration, but the nature of the game is such that it's easy to get caught up in the action and spend many an hour at the keyboard without getting bored. It's by no means the first of its type, but it has a lot more depth than some similar games.

## JUDGEMENT

*Imperium* is very well put together and the whole game interlinks with itself intricately, which makes it great fun to play. The aliens are an intelligent bunch, which makes for good interacting opportunities, and it's a game that also rewards smart thinking and punishes rash or ill thought out actions. Definitely a game for the solo player who likes reams of statistics to ponder over and who likes to juggle limited resources making them work to their best advantage.

GRAPHICS	6
SOUND	4
INTELLECT	7
ADDICTION	7
OVERALL	86%



Half past five on the 22nd and the Zulus make their first attack on the south wall. With 18 men on guard the situation is in hand.



The ordering menu. Private No 88 has been ordered to shoot.

## LASTING INTEREST

The game takes ages to play, so prepare yourself for some long games – there is a save option. Unfortunately the ability to play only one side and one scenario limits the game's lasting interest because once you've achieved the victory conditions (which shouldn't take a dedicated and competent player too long) it's doubtful you'll want to go through the whole thing all over again.

# RORKE'S DRIFT

IMPRESSIONS £19.99 ■ Mouse

Most computer wargames are based on the board wargame principle, with the computer handling all the mundane tasks and getting rid of the need for all those precariously-balanced cardboard counters.

There is another school of wargamers, though: the miniature wargamers. No, they're not really terribly small people; they're so called because they fight wargames on large table-tops using miniature soldiers to represent the forces of the battle. *Rorke's Drift* is Impression's attempt at recreating a table-top wargame on a computer.

If you're unfamiliar with the scenario (surely you must have seen the Stanley Baker movie *Zulu*?) it's the battle between 137 British soldiers and about 4,000 Zulu warriors during the period January 22-23 1879. The British are camped at a small group of buildings and have secured the area with biscuit boxes and mealie bags. As the commander of the British forces it's up to you to hold out against massive odds.

The game is played in two phases: orders and combat. Both are time based (in game time, that is). In the attempt to keep the game feeling as much like a table-top game as possible the ordering system means you have complete control of each and every man. That includes deciding the facing position of the man, whether he should walk, run or charge to a certain place, when to load and aim his rifle and when to rest.

Orders are issued to each man (there is a repeat order option

which comes in handy when ordering a large number of men to do the same thing) and then by selecting exit you enter the battle mode and each man follows his orders until either they fulfil them or you interrupt and re-issue orders again.

Controlling the play is the game clock. During the orders phase, the game clock stops and as soon as you enter battle mode the clock starts again. The victory conditions are simple enough – the British commander just has to survive through to the next day.

As the game progresses, survival involves re-issuing ammunition to your men, using the medics to tend to the wounded and various other ancillary operations. With the odds stacked against you the simple fact that you have rifles and the Zulu's don't is not going to save your skin. The ability to use your limited forces to their greatest advantage is of paramount importance. **Andy Smith**



The north wall. Things are hotting up as the Zulus start sending larger waves against the British.

## GRAPHICS AND SOUND

Forget the sound; there's only a short burst of Men of Harlech at the start and that's your lot. The graphics are much better using a good, if forced, 3D perspective. All the characters are well drawn and though the animation isn't the smoothest it doesn't impede the gameplay.

## JUDGEMENT

Impressions have really stuck to the rules in order to get this as much like a table-top game as possible. This doesn't always work to its advantage. The ordering system is unwieldy and awkward and can be very frustrating – it's so annoying to watch two soldiers walk into each other to reach different objectives and then both just keep colliding with each other until you interrupt and send them different ways.

Simple problems like this mean you often have to adopt unrealistic ordering sequences which just makes things unnecessarily tedious. It's tedious enough when you have to fire every man's rifle for him (especially when you have a line of 100 men and have to pick the target and fire for each one, every single time). It's the sum total of all these niggles that break the game and turn it into more of a chore than a pleasure for the average player.

Miniature fans and wargamers with a particular liking for the scenario only need apply for this one.



After every shot a report tells you if you hit or missed the target (corpses are instantly removed from the battlefield).



The report screen keeps a total of the sides' losses and injuries. Things look OK for the Brits.



The game area. Arrows indicate areas where the action's at.

GRAPHICS	7
SOUND	2
INTELLECT	6
ADDICTION	5
OVERALL	62%

ATARI®...THE POWER BEHIND



# THE POWER OF THE PYRAMIDS

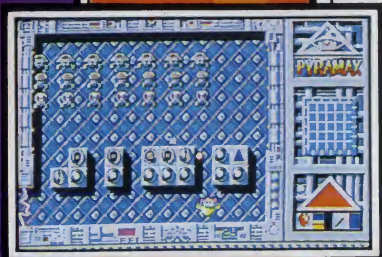
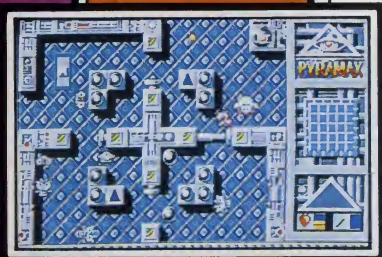
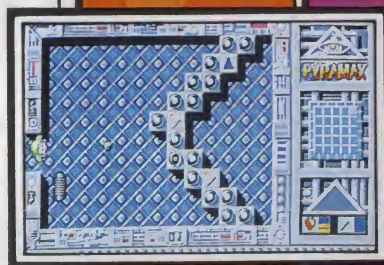

Screen shots from various systems.

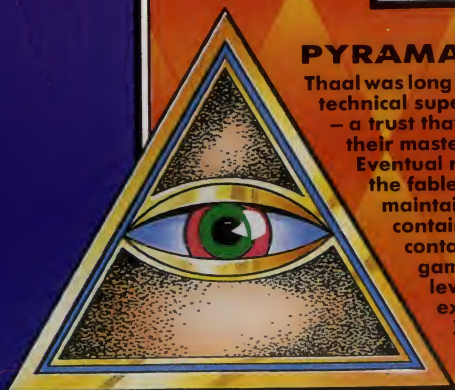

## PYRAMAX

Thaal was long inhabited by a race of intelligent humanoids who in a quest for technical superiority placed evermore trust in their Roboslave creations – a trust that was eventually misplaced as the slaves grew resentful of their masters. The rebellion was swift. The Thaalian defeat everlasting. Eventual remorse at their masters' downfall led the androids to create the fabled Pyramid of Thaal – a shrine in which the robotic devices maintained a perpetual vigil over the Thaalian Crystal – said to contain the total knowledge of this former race. The pyramid also contained fabulous recreations of the Thaalians favourite video games and immense riches were scattered throughout its six vast levels, held in secret until the day, you, Pyramax – intrepid explorer of the galaxies – finally penetrate the acid forests of Xandar and discover the long lost treasure hoarde of ancient Thaal.

ATARI ST · AMIGA



REACH OUT FOR THE POWER OF ARC  
ATARI ST · CBM AMIGA · IBM P.C.

ARC P.O. Box 555 Slough SL2 5BZ

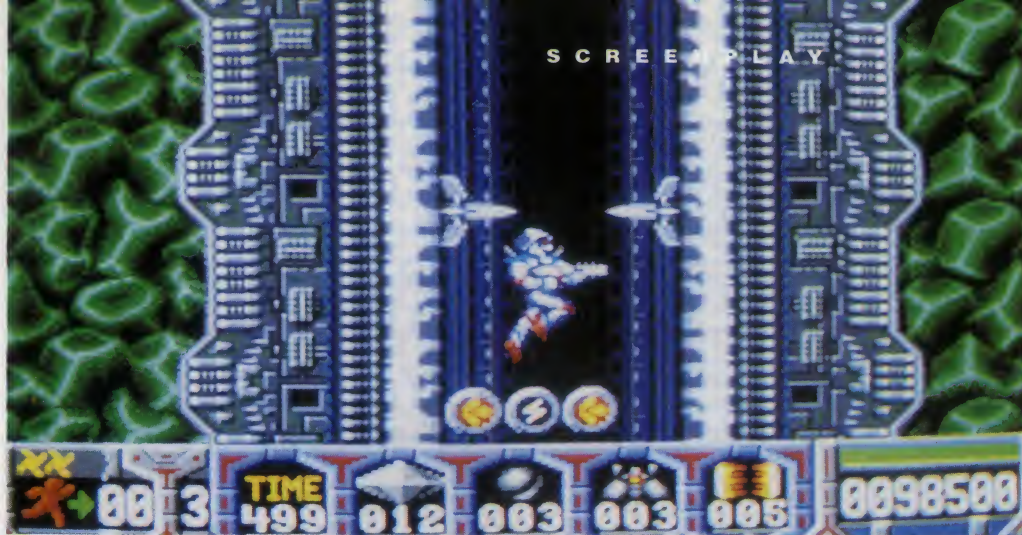

Collect the extra power ups as you drop into the complex.

# TURRICAN

RAINBOW ARTS £19.95 ■ Joystick

Everyone has nightmares at some time. But where do they come from? Legend tells of a creature with a highly-developed psyche, due to his three-headed mutant form. His influence was so powerful that everyone on Earth was touched by his evil thoughts. The human race was gripped with fear and worry and terrible nightmares made the dark a cold and frightening place. This creature was named Morgul.

A heroic warrior named Devolon managed to battle him and banish him to a hidden dimension inhabited by strange creatures incapable of emotion and therefore immune to the fears and dreams he instilled in mankind. Years have passed since this age, with humans still occasionally troubled by nightmares and worry. Even though Morgul has been trapped, his influence still breaks through.

However, mankind has once again begun to experience horrific dreams, worse than ever before. No-one will venture out onto the streets during the hours of darkness. One terrifying thought is lurking at the back of everyone's mind – Morgul has returned.

You are Turrigan – one of the few remaining people who have not lost all sense of courage. You have been kitted out with the latest state-of-the-art firepower ready for the mission ahead – to find Morgul and kill him.

You must travel through five areas of the realm that Morgul has created for himself, fighting off the



This one is a well mean mother. Get the beam on him!

creatures that he has warped to obey him. To begin with you are armed with a rapid-firing pulse rifle and a flash-beam which can project a directable stream of lightning to take out enemies at a distance. Extra energy packs can be picked up around Morgul's fortress and converted into weapons such as lasers, spray

rifle packs and energy shields. Some are freely available, but others are hidden and have to be carefully searched out before they can be collected.

At the end of the last area is the evil Morgul. Can you use the weaponry available to destroy him? Who knows... but it could give you dreams for a while! **Maff Evans**

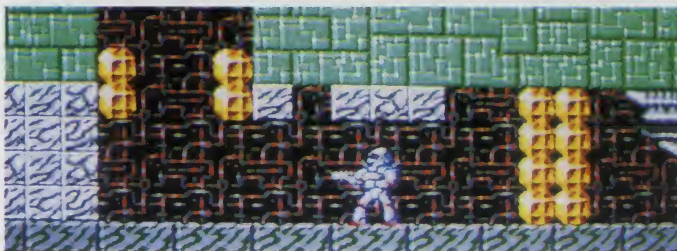

Ooh, look at all those lovely diamonds. Give them here...

## LASTING INTEREST

The feel of the weapons is easy to get to grips with and to begin with it's fairly easy to blast the living daylights out of all the attacking creatures. Things do get a lot tougher though, despite the extra pick-ups to help you on your way. A lot of playing practice will have to be put in before you get any distance into the game and it will be quite a while before all the levels have been conquered.

## GRAPHICS AND SOUND

Turrigan's appearance is very much in the mould of many coin-op machines. The graphics are colourful, smoothly animated and atmospheric and the sound backs the gameplay up superbly with a range of powerful effects. Even the music has been done well, using real chords – a point not often apparent in game soundtracks. In fact Turrigan could well be an arcade game – except you don't have to put money in all the time!

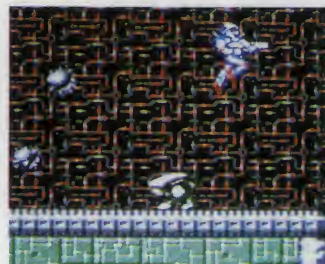

Turrigan is pursued by bouncing bombs as he jumps a robot.

## JUDGEMENT

Some people may argue that there are too many shoot-em-ups on the market already, and this would be a fair point. The problem is that a great deal of them are pretty half baked, pale representations of established coin-op machines. However with a game like Turrigan, not too many people could complain about the addition of another blast to the ever-increasing list. Rather than being a rip-off, Turrigan could well be in an arcade (in fact don't be surprised to see some of Turrigan's ideas finding their way into future coin-ops). The gameplay itself isn't particularly groundbreaking, but it is frantic fun and extremely well presented and should appeal immensely to fans of the old 'spraying bullets' genre.



Launch your flash-weapon to kill that evil 'orrible flying robot.

GRAPHICS	8
SOUND	8
INTELLECT	3
ADDICTION	8
OVERALL	88%



# FIGHTER BOMBER BOMBER BOMBER BOMBER BOMBER BOMBER

## ADVANCED MISSION DISC



Activision proudly presents the eagerly awaited Fighter Bomber Advanced Mission Disc

For those who have taken on the original challenges in Fighter Bomber, there are now sixteen more exciting and demanding missions, with new enemies and tougher artillery.

...A secret meeting of terrorist leaders is taking place aboard a submarine surrounded by heavy SAM defences – with quick wits and sharp reactions you must wipe out the enemy and destroy the whole flotilla without rearming or refueling...

...A civil airport is surrounded by enemy tanks, APCs and troops, with enemy reinforcements approaching from the North. It is likely to be over-run shortly unless swift action is taken. But with only one load of weapons will you be up to it?

**Special features:**

- Extra stunning graphics – submarines, radar towers, parked jets, windmills, trucks, mobile SAM launchers.
- This one mission disc doubles the enjoyment and thrill of the original Fighter Bomber



**ACTIVISION**  
SIMULATION SOFTWARE

© Computer Game Vektor Grafix 1990  
All Rights Reserved



Mail Order: Intermediates Ltd., P.O. Box 847, Harlow CM21 9PH Tel: 0279 600197  
Consumer/Technical Enquiries: 0734 310003





Reflections on the ethics of chopping up living beings...



# HERO'S QUEST

SIERRA ONLINE/ACTIVISION £34.99

■ Keyboard and Mouse

The people of Spielberg valley need a hero. A true champion of the weak, who is valiant in battle. Reckon you fit the bill?

*Hero's Quest* begins with a decision as to what sort of hero you want to be. Fighters are stereotypes with broadsword, shield and brain damage. Magic users are the intellectual types – they start off as wimps but build up a decent collection of spells and can swagger with confidence. Thieves are devious, skulking about shadows with a lockpick at the ready...

Rather than your Amiga randomly deciding the character's abilities – strength, intelligence, agility etc – you assign a meagre collection of points onto a standard profile (so fighters are always better than average in close combat, but you can stick some extra points on for overkill). This makes hero design much more satisfying: custom heroes!

Getting into the game is easy. Spielberg is located in Spielberg valley, a large playing area with plenty of spooky woods, caves and inhabitants. You move around the three dimensional on-screen scenery; press the key or move the mouse and your hero stomps off in that direction until an obstacle gets in the way.

Remember text adventure games? The computer gives a description, asks "What now?" and then you type in your responses. *Hero's Quest* lets you type in commands at any time, which



Want information? Check out your local Adventurer's Guild

freezes anything that's happening on the screen – even combat.

Therefore, you can stroll up to anyone or anything you see and try to start up a conversation. There's no need to hack everything you meet into quivering little lumps, unlike such games as *Bard's Tale*.

Monsters are classified into four categories: the Humanoids, the Inhumanoids, the Undead and the Unknown. The handbook lists a few little pointers that indicate it's a monster you're facing: if it oozes green ichor, eats people, collects half-eaten corpses, drools, gibbers or slavers, attacks without provocation, twitches tentacles or will not eat spinach – it's a monster!

The combat is simple in principle, but difficult to master. A view appears, from over your hero's shoulder. Depending whether the monster is at close range or dis-

tance you have six manoeuvres to choose from: thrust, swing, duck, dodge, shield block and parry.

Whenever the pointer symbol on the screen flashes, you must press the relevant key for the action you want. This introduces thought into combat, as you have to see what your opponent is doing before making your move. Blast-em-up fans like to hammer on all the buttons, and get confused when they end up dead. You have to think more about this combat system.

Combat is only a part of the game. At first, the player explores as much as possible, talks to people, meets the odd Dryad (that's a good bit) and can even take a job at a stables. Later, the quests have to be solved, adventures have to be completed – life in Spielberg valley is complicated.

Pat McDonald

"What can I do for you? I can sell you potions if you like. I also buy spell components if you are interested in gathering some for me."



The healer can patch you up – but will only do it for a price!

## GRAPHICS AND SOUND

The 3D locations look good. It's not just the quality; the number of scenes to explore is enormous. A few more frames of animation, in places, would have been the icing on the cake.

Sound is used more subtly, with birds twittering away, a couple of musical themes and the occasional din of battle – bit of a let down there but not enough to make the game less enjoyable.



Combat is sometimes simply unavoidable, but always fun.

## LASTING INTEREST

Loads of disk swapping is the only hassle. To see a world come to life is amazing: to play only a part of it and try to overcome all the problems and share the triumphs of becoming a hero is a long-term (and fun) way of spending time. Lots of puzzles, an adrenalin rush when a monster appears and a definite goal are what real adventurers need.

Name	Strength	Intelligence	Agility	Vitality	Luck	Weapon Use	Parry	Dodge	Stealth	Pick Locks	Throwing	Climbing	Magic
	45	10	15	25	10	30	25	10	0	0	10	0	0
Points Available	0 / 50												
Health Points	31 / 31												
Stamina Points	20 / 20												
Magic Points	0 / 0												
	TAB to move around. Arrows to adjust values.												
	Start Game												
	Cancel												

One kill-ready hero who is just about ready for a quest.

## JUDGEMENT

Just to call this a game is inadequate: it's a five-disc work of art, brimming with imagination, humour and thought.

Shame about the price, but for once it genuinely reflects the amount of effort that's gone into it. A lovely game.

GRAPHICS	8
SOUND	6
INTELLECT	7
ADDICTION	9
OVERALL	92%



A later level - it looks easy, but one mistake can make the whole thing impossible.

# TURN IT

**KINGSOFT/ THE SOFTWARE BUSINESS £19.99 ■ Mouse**

All the useful things in the world today were probably invented thousands of years ago by the Chinese - like gunpowder, chopsticks, bicycles and those little water bottles that fix on the side of hamsters' cages. They were also pretty adept at keeping themselves amused during those long, dark nights and invented almost all types of Patience and Solitaire including, erm... well, probably quite a few.

Another game they invented was Mah Jong, normally a two or more player tile game that's a weird cross between Dominoes and Rummy. They even managed to create a game of patience using the Mah Jong tiles - often

called *Shanghai* - and *Turn It* is a straightforward variation of that.

*Turn It* is a much simplified version that involves looking at a screen full of face-up tiles and then selecting identical pairs to remove them from the board. There are a couple of rules, however. First, you have a time limit for each screen (the length of time can be altered by selecting a different skill level at the start of the game).

Then you must remember that the two tiles in a pair must be connected by a line which is drawn along the edge of the playfield and/or across tiles that have already been turned. Life at this stage would be bearable, but what really makes it tough is the rule



The next level. A tougher this one - things can go very well for a while, but it's easy to get stuck and end up with a small group on the left and a small group on the right.

stating that the line connecting the two tiles to be turned can turn no more than twice (every turn of the line is through 90 degrees).

There are 50 levels to the game (a password is given after every 10 levels) and the levels increase in difficulty in a variety of ways. Usually the number and the complexity of the tiles increases, so you have more to manoeuvre around, but sometimes you're up against a crippling time limit. There are occasional pairs that can either be a help or a hindrance once they're turned, like the diamond tiles that give you an extra 10 seconds or the skulls that deduct points if you do have to turn them. **Andy Smith**

## GRAPHICS AND SOUND

Neither is outstanding, though the music is all right and the sound effects are fine. The tiles have all been well drawn and everything looks about as good as you would expect.

## LASTING INTEREST

The difficulty tuning on the screens has been set well and with 50 levels to complete this will keep you going for some time. The only disadvantage is that once you know a level you'll complete it every time.

## JUDGEMENT

A very nice game that's been well done and will entertain whenever you have a few minutes to yourself. This is a good variation of the classic, so if you don't own at least one already this is as worthy of consideration as the rest.

### THE ALL-IMPORTANT PATTERN OF PLAY



The easy first level. The tiles are simple and it's easy to recognise pairs.



Things are going well and here's another pair of tiles to turn - just click with the left button.



Near the end of this layout, now. Just turn this pair of faces for an extra four points.

<b>GRAPHICS</b>	<b>6</b>
<b>SOUND</b>	<b>4</b>
<b>INTELLECT</b>	<b>6</b>
<b>ADDICTION</b>	<b>7</b>
<b>OVERALL</b>	<b>83%</b>

# Quickjoy

## Joysticks



124-TURBO  
6 Microswitches.  
Autofire. £9-95



120-JUNIOR STICK  
Twin Fire Buttons.  
Hand Held. £6-95



119-JUNIOR  
Twin Fire Buttons.  
£5-95



125-SUPERBOARD  
10 Microswitches.  
Digital Stopwatch.  
Autofire. £19-95



126-JETFIGHTER  
6 Microswitches.  
New Pilot Grip.  
Autofire. £14-95



127-TOP STAR  
Steel Shaft.  
Microswitches.  
Autofire. £22-95



II PILOT

£7-95

122



SUPERCHARGER

£10-95

123



INFRARED

£39-95

130



M5 FOR IBM PC.

£19-95

201

QUICKJOY JOYSTICKS. Leading in design, technology and choice. Check out the range and features. Buy with confidence.

\*Now available from Larger Branches of....

WH SMITH

John Menzies

Selfridges

Hamleys

.... and all good computer dealers.

SPECTRAVIDEO

Unit 27 Northfield Industrial Estate, Beresford Avenue, Wembley, Middlesex HA0 1NU England.

Telephone: 01-900 0024

Facsimile: 01-903 6625

\*Subject to Availability



The brave Earth Commando takes a plunge back in time through the warp tunnel

# TIME SOLDIER

**ELECTROCOIN £24.99 ■ Joystick**

The Earth is in danger. The seven Earth Commandos responsible for the protection of the planet have been captured on a mission to attack the evil Gylend. Five of the Commandos have been enslaved and sent into the voids of time with little hope of rescue.

Only two of the commandos survived – Yohan and Ben – who must now battle through various time zones, from the Primitive Era through Medieval Japan to Future World, fighting off all manner of historic creatures and warriors in

an attempt to rescue their captured comrades. All the commandos must be freed before they can travel to Gylend's domain and put the tyrant to rest once and for all.

You control one of the Commandos on his perilous quest through time, starting off with a limited energy supply and a measly single-shot weapon.

Along the way you may find additional items such as speed-up devices, three-way cannons, missile launchers and laser weapons. You must use these

items to blast your way through Gylend's defences and rescue your friends. But take care, since once your energy runs out it's time for you to disappear off to the great big time machine in the sky.

**Maff Evans**

GRAPHICS	4
SOUND	3
INTELLECT	1
ADDICTION	3
OVERALL	49%



Gladiators come marching down to attack you when your guns are at their least powerful.

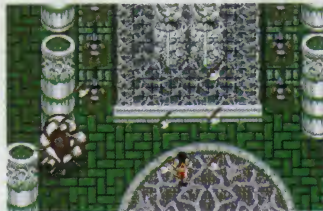

Let those Romans have it while their backs are turned and they present their 'vulnerable' side.



Don't stop to admire that pretty floor, because this dragon is a tough opponent!

## GRAPHICS AND SOUND

Despite being based on a well-presented coin-op, the Amiga version of *Time Soldier* is rather unimpressive in both graphics and sound departments. The scrolling is slow, the sprites small and scraggly animated and the sound is weak to say the least. If an arcade conversion is to be a hit nowadays, these are the things that most care has to be taken over, but Electrocoin have simply 'made do' with a rough interpretation of the original.

## LASTING INTEREST

From the outset *Time Soldier* is a difficult and frustrating game to play, but even if you do manage to get any significant distance into the game, the gameplay doesn't alter to any extent. This goes to make a game which is annoying and repetitive, which will undoubtedly cause even the most dedicated coin-op fans to give up in short order.

## JUDGEMENT

*Time Soldier* seems to be a throwback to the days when coin-op conversions first began to appear on home computers. Fans would simply go out and buy the game just for the name, regardless of the quality. However in this day and age of superb graphics, first-rate conversions and brilliant original games, a real effort has to be made to ensure that the translation stands up well as a game in its own right. Unfortunately *Time Soldier* doesn't really manage this, seeming much like a case of "let's get the name out, quick". Even if you are a fan of the original don't leap straight in, because this is a below-par implementation of a rather forgettable coin-op.

# GRID RUNNER

**LLAMASOFT £10.95 ■ Mouse**



Psychedelic mayhem in Minter's latest blast-em-up.

Anybody who missed out on Jeff Minter's 'alternative' games on 8-bit can try his psychedelic delights in *Grid Runner*.

The idea of the game is simple; you control a ship with detachable nose-cone. Holding down the right button drags the nose-cone around, otherwise it sits where it is and splits your shots into three bullets, dealing mayhem to swooping invaders. And what do you have to do? Avoid the railgun's shots from the sides of the grid, pick up the bonus tokens and blast the Bejesus out of everything else. Simple.

The flashing, cycling and pulsating psychedelic colours are the main feature of most, if

not all, of Jeff's games and indeed *Grid Runner* has cycling and pulsating colours at every opportunity. The effect is pretty – if a little disorientating – and provide a suitably ethereal backdrop to the gameplay.

The action itself is fast and frantic, so despite its age *Grid Runner* provides an enjoyable couple of days' blasting. The only fault is the sound. There is no music to speak of, and the effects are just obligatory beeps, whizzes and crunches. Not too good considering the power of the machine. Whinge aside, the game is – as pop hero Alan Freeman would say – 'A classic blast from the past, pop-pickers!' **Maff Evans**

**GRAPHICS 5 / SOUND 3 / INTELLECT 2 / ADDICTION 6 / OVERALL 71%**



Killing these monsters is easy! YIKES! Where's me trousers?

GRAPHICS AND SOUND

Given the time that Elite had to bring out this conversion, it's not surprising that the game is extremely close to the arcade original. In fact the only difference is that you aren't asked to put any money in! All the introduction and intermission scenes have been included, from the abduction of Sir Arthur's love to the map of the game before play. One thing that was missing from previous conversions was the grave spirit that emerges to turn Arthur into a frog, but a few blasts into a grave-stone on the Amiga version and hey presto! Out comes the spirit! A lot of care has been taken over both sound and graphics to recreate the feel of the coin-op, and it certainly shows. Both are superb.

LASTING INTEREST

Anyone who has played the arcade version to any extent will be able to quite easily get into the action, but this also means that they may complete it fairly quickly. However, even if you do get to the end, it's still great fun to pick up and have a bash at every now and then.

# GHOSTS 'N' GOBLINS

ELITE £19.99 ■ Joystick

After the success of US Gold's *Ghouls 'N' Ghosts* conversion, which received a Format Gold in these hallowed pages, it was inevitable that its predecessor would make its way to the 16-bit machines.

For the six people that have just landed from Mars and don't know anything about the game, the plot tells of brave Sir Arthur, valiant knight and bold warrior. While resting with his girlfriend after a particularly tough quest, an evil demon swooped down and swept away the fair maid to a dark and dangerous hiding place deep within a mountain.

Arthur quickly dons his magic armour and sets off to the rescue, passing through the various creature-infested sections of the demonic realm. He must fight off

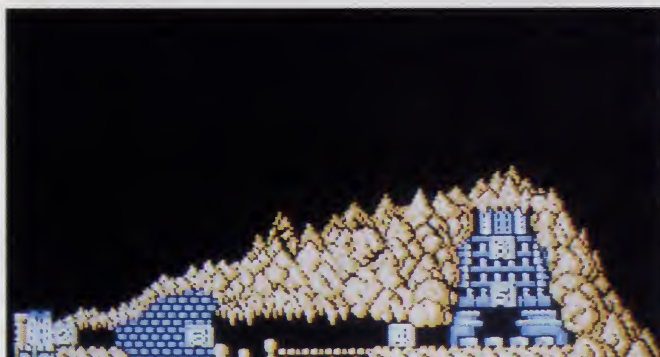

The map shows your objective - the demon's castle!

zombies in the graveyard, ghostly flying monks in the forest, tattooed ogres in the ghost town and bats in the caves.

Initially Arthur is armed with an endless supply of sawn-off lances to throw at foes, but occasionally a creature carries a pot containing

treasure or new weapons, such as torches, axes or daggers. If one of the creatures manages to land a hit on poor Sir Arthur he will lose the protection of his magic armour - one more hit and the brave hero turns into a bag of bones for the vultures to pick at. **Maff Evans**



That's a very strange creature. I wonder what he does...



Ah! That's what he does. Oh well... gribbit, gribbit.

JUDGEMENT

Despite its age, *Ghosts 'N' Goblins* is well presented, highly playable and an enjoyable romp. Techno-snobs shouldn't be put off simply because the follow-up is available, since the prequel has a feel and charm that *Ghouls 'N' Ghosts* somehow lacks. Veterans of the coin-op should get hold of a copy, even if it's just for nostalgia's sake, and newcomers to the tales of Arthur and his foes could do a lot worse than take a brief visit to this weird and wonderful world.



Arthur is chased around in his underwear by ghostly monks.



Arthur gets his tin trows back.

GRAPHICS	8
SOUND	7
INTELLECT	2
ADDICTION	7
OVERALL	80%



THE  
OFFICIAL



# Everton F.C. Intelligensia

Available for:—

Amiga £19.99

Amstrad Cassette £9.99

Atari ST £19.99

BBC Cassette £9.99

Commodore 64 £9.99

IBM PC 5.25" £19.99

IBM PC 3.5" £19.99

Spectrum Cassette £9.99



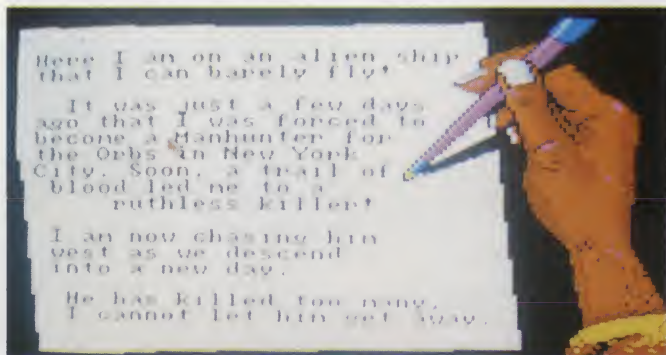

The start of the search. Forced by the Orbs to become a Manhunter, you set off into the streets of San Francisco.



# MANHUNTER 2

SIERRA ON-LINE/ACTIVISION £29.99

## ■ Mouse/Keys

It was one of those days. One minute you're minding your own business and the next, your home town is invaded by aliens. Everyone is forced into wearing rather fetching brown robes and you're offered the chance to be a Manhunter: an 'esteemed human'. As such, your aim in life is simple: find the villains, then kill them. What more could one ask?

*Manhunter 2 - San Francisco* begins where *Manhunter - New York* left off. You're on the hunt for a human murderer called Phil who has escaped into the heart of San Francisco. So your task is set. Unfortunately this task isn't as simple as it first seems. The more you investigate the more you uncover, from Genetic Engineering to major corruption, and your initial plans are changed as a more comprehensive understanding of the situation develops.

An interesting feature of the game is the inclusion of 'exciting arcade sequences'. Unfortunately, this adventurous gambit hasn't really come off. You are offered three skill levels which are tantamount to the same, with little if any difference. One such sequence near the beginning of the game is just about impossible. The aim is to get through the tunnel by kicking rats and punching bats - which would be quite a pleasant break from wandering the streets, but the slow keyboard responses and the random nature of any attack lowers the chance of survival to around zero.

Of course you'll persist, against your better judgement, just to get into the game somehow. Toughness based on luck rather than skill really does rile you, especially when you wish to

get into the game proper rather than pussy-foot around in some amateurish arcade sequence.

**Nick Walkland**



Do you really want that flask?

## GRAPHICS AND SOUND

Graphically *Manhunter 2* is adequate, although the images are often rather crude and basic; the staggered and gaudy coloured graphics are more reminiscent of early Commodore 64 software than a game for the Amiga in the Nineties. The animation is tediously slow and jerky, so they become something to endure rather than enjoy.

Sound effects and music are best left unmentioned, which should give an idea of their quality. You can always turn it off. All of which is disappointing from a software house that was getting much better at effects.



Is it a good idea to peer under the pier while strange dudes in wierd duds are strolling around?

## JUDGEMENT

All-in-all *Manhunter 2* is a let-down. Especially after the success of *Manhunter* in the States, you'd expect something better. The adventure has so much potential, and it does have quite a gripping storyline - but the slow gameplay holds it back.

Big problem is the arcade games. Frankly, these are no joke. I'm sorry, but I haven't played such poor arcade games since *BASIC Invaders!* Why they bothered with the arcade parts of the game, when all they do is distract and irritate, is beyond me. Experimenting too much into mixing various forms of games, Sierra have got themselves swamped - lets hope they can pull themselves out and produce more of the games for which they are rightly famous.

GRAPHICS	5
SOUND	2
INTELLECT	7
ADDICTION	4
OVERALL	54%

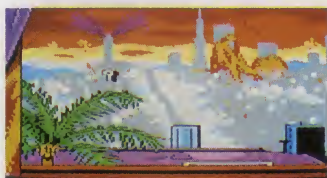

It's hot out on those streets.

One of the most impressive options of the game is the use of a personal computer to track city occupants, a nice touch which lets the player get more into the game via a realistic street map. The game is totally mouse-operated - there is absolutely no need to type in anything - but keyboard control of the arcade sequences and quick decisions can be made via function keys.



Looking for clues...

## LASTING INTEREST

*Manhunter 2* can be quite thrilling, especially thanks to its macabre style and relatively witty presentation. Unfortunately the puzzles are either blatant or painfully awkward, a constantly recurring problem being that you find objects without getting full details on what they are. This may be fine every now and again, but when it crops up with almost all objects throughout the game it does become a pain.

An adventure which decides the route for you and shows you the scenes it wants you to play hardly inspires any particular interest. However, once you get the feel of the thing the atmosphere rises, and you can begin to enjoy yourself. The game then presents its main problem; the sheer stop and start quality, with hardly any smooth flow.



"Armed guards alone aren't enough to stop the Defenders of the Earth!" Bigmouth strikes again just as the hover guards swoop in for the kill.

# DEFENDERS OF THE EARTH

ENIGMA VARIATIONS £19.99 ■ Joystick

If you're the kind of person that never sees Saturday mornings, never mind Saturday morning television, then you may not have caught the 'all-new' Flash Gordon adventures in the form of *Defenders of the Earth*. It's the usual American cartoon tat, with 'classic' heroes teaming up with a bunch of right-on youngsters amid a hail of spaceships and laser-blasts, as the evil villain attempts to take over the world.

In *Enigma Variations'* new computer implementation of the cartoon you play Flash himself, romping through Ming the Merciless's fortress fighting off his minions until the evil ruler is tracked down in the Throne Room.

Flash starts out armed with four shield-packs and an automatic weapon. Hits from guards and other defence systems reduce Flash's shield strength, but extra energy packs can be picked up along the way to top up the diminishing supply. Also scattered around the fortress are extra weapons, such as laser blasters and high-speed magazines.

At various points, Flash may come across an obstacle such as a gap in the floor, a locked door or an electric field. By activating a call signal, Flash can ask one of the other Defenders to help him pass the obstacle – for example, Mandrake can magically create bridges, the Phantom can kick doors and Lothar can break locks.

If all Flash's energy packs run out, Dynak-X transports him back to safety all ready to go back and fight another time. **Maff Evans**



Watch out! That humpety-backed guard's coming to sort you out.



Attack of the blue robots! That evil snake doesn't help, either.

## GRAPHICS AND SOUND

The intro music to *Defenders of the Earth* has been faithfully converted to the Amiga: in other words, the game's theme is the usual tacky Saturday matinee 'anthem' that kids can sing as they leap around re-enacting their favourite characters' antics. The graphics have a colourful cartoon-like appearance, but the animation on all characters is simplistic to say the least. This is one of the most important things to consider when converting a cartoon to computer, but *Enigma Variations'* design unfortunately doesn't quite capture the feel of an action cartoon.

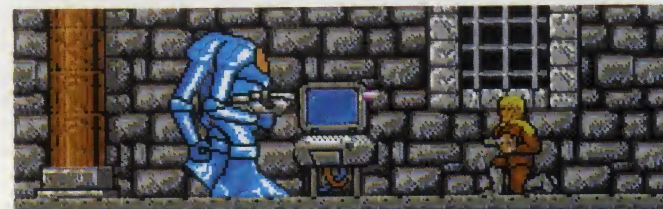

He looks nasty. Should have taken more care on the terminal!



## LASTING INTEREST

The gameplay is fairly basic, and each level is pretty similar to the last with the exception of a few more robots and guards to encounter. To add to this, the going is frustratingly difficult, which will have even dedicated shoot-em-up fans turning the air blue with profanities and threatening dangerous (and probably illegal) action against the computer before throwing the joystick down and leaving the room.

## JUDGEMENT

It's rather poetic that such a run-of-the-mill cartoon has been turned into a run-of-the-mill shoot-em-up. The graphics and sound do the job, but the gameplay, unfortunately, is lacking in originality, excitement and variety – all things that a shoot-em-up needs to be impressive in the Nineties. It's fun for a couple of games, but frustration sets in soon after, discouraging budding Defenders from struggling through, no matter how big a threat Ming is to the universe.

GRAPHICS	7
SOUND	4
INTELLECT	2
ADDICTION	4
OVERALL	58%



# WARNING!

Do not play this game  
if you are of a nervous disposition

NOW AVAILABLE  
ON THE  
AMIGA & ST

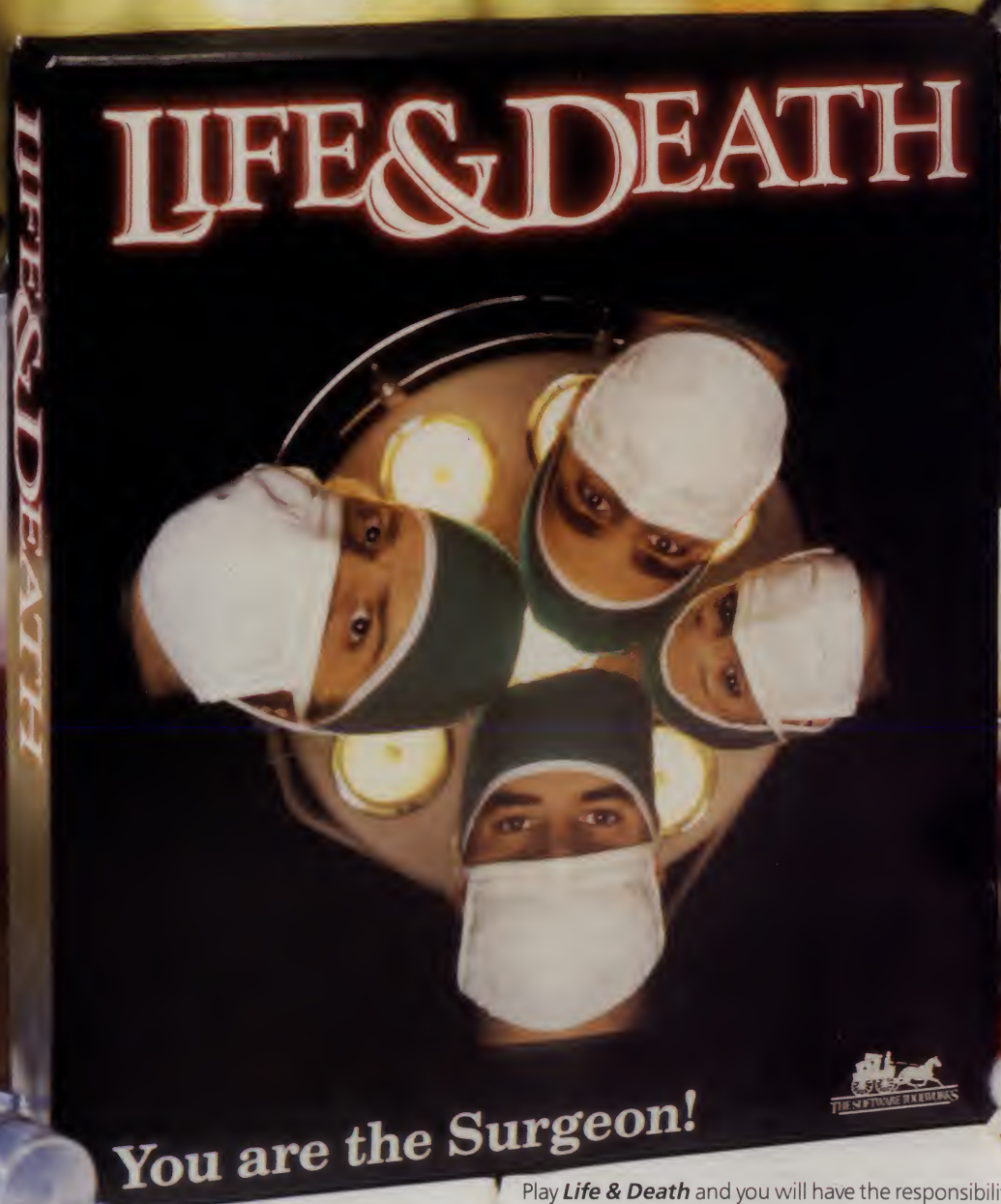

Distributed by



Play *Life & Death* and you will have the responsibility of holding a human life in your hands as you cut into living flesh.

In this – the world's first interactive medical movie – you'll enter the tension-filled atmosphere of a busy hospital. Talk with your patient. Read charts. Order X-rays, blood tests and other laboratory reports. And when the time comes . . . you will pick up the knife!

In the operating theatre, your skill will determine whether your patient goes to recovery . . . or the mortuary.

Available for IBM and compatibles, Apple II/Mackintosh, Amiga and Atari ST.

M I N D S C A P E

For further information on Mindscape Products and your local dealer contact  
Mindscape International Limited, PO Box 1019, Lewes, East Sussex BN8 4DW. Tel. (044 486) 545/547

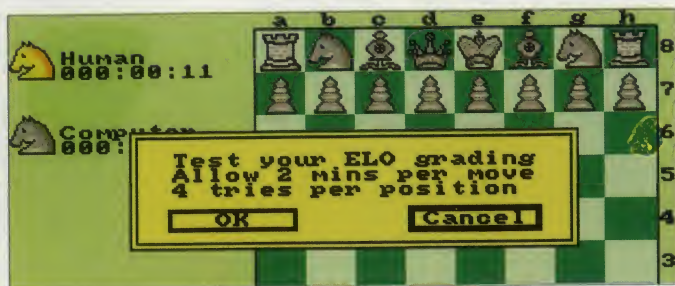

Now's the time to put your knight on king 5 where your mouth is. The ability to test your grading is a definite challenge in itself.

# CHESS CHAMPION 2175

OXFORD SOFTWORKS £29.95 ■ Mouse

Put an Ottoman Emperor and a Russian (or Georgian or Lithuanian) peasant in the same room and they wouldn't know how to communicate. Then introduce a chessboard and – bingo! – they will be on the same wavelength for as long as you let them play. That's one of the beauties of chess. In this country, the game has had a 'snob intellectual' value attached to it; this is slowly being broken down and one of the prime movers in this noble war of attrition is the home computer chess game.

Chess Champ comes with all the standards which we have come to expect; a 3-D board, 'take back' moves, booked openings and saved games. Unlike its predecessor, Chess Champion 2150, little brother comes with no speech support. The reason for this is that a bigger opening library has been added, the search extended and a 'Chess Engine' – the brains behind the beast – of 100k incorporated.

Once booted up – for some reason the screen shows a 2-D board where the pieces change into toys and animals, but at least it keeps you interested – you have to negotiate the 'what does word 123 in paragraph 23 on page 2' protection. Then you are taken straight to the flat board display with the clocks ticking. Default games have you playing white. Click on the left mouse button, with the pointer off the board, and

a series of menu options are shown at the top of the screen.

Before getting into a game, it's an idea to test your grade. This function gives you 24 set-pieces to negotiate. Once you've completed the lot you are given a rough idea of your place in the international pantheon of chess players. Nice idea, but it can be a tad punishing on the ego.

Just because you are defaulted to play white, doesn't mean it has to be that way. As with all computer chess it is a wise idea to suss the machine's ability to play white and – this is normally a good one – see how it reacts to castling Queen-side. Chess Champ' copes well with both options with some style, an attribute sadly lacking in a number of other games. Attempting to stuff it with a Queen/knight check was also handled with great aplomb – that normally nails 'em too.

One impressive point about the game, although it smacked of playing a crusty old pro trying to impress by dropping in chess technicalities – is that names of openings are displayed on screen as soon as the software recognises them. Queen's Gambit slaps on the screen early, but such lovelies as the Nimzo-Indian Defence take their time – and rightly so. It plays like a crusty old pro' as well: more's the pity for the chess smart-arse or naive beginner

Tim Smith



Get out of that you computer pretender...it probably will 'un all



Where to go from here? The knight's are drawing in or what!

## LASTING INTEREST

It's chess innit? Lasting interest? There's thousands of years of it, bit of a silly question really. As for the software, the options to keep your own booked openings, continually assess your grading and the different levels which are included should make Chess Champion 2175 last until the next version comes along. The fact that it can be moulded to your tastes and playing ability (though not yet to your style or imagination) gives it a fair edge over challengers in the micro-chip Kasparov stakes. Unless you're Nigel Short or plain irritatingly good then Chess Champion will keep doing no end of good for your game for a long time to come.

## GRAPHICS AND SOUND

We'll get the sound question over with right now. Save for the occasional bleep to signify a move, there isn't any. A good thing too, the last thing you want when training to win a £10 bet with 'Arry the chess shark down at the Rook and Ferret, is Adamski-International-Beat'S'Express blaring out to announce a check.

Graphically, it's a little on the ragged side. This is probably because looks are sacrificed to playability, another good point in my mind. Movement comes with a number of options which range from an irritating 'slide' to a zappy 'Fast Move' variation.

You do get the chance to alter the board and piece colours, so why quibble. The real chess aficionado will have a true board to hand anyway – you can't really play chess without some tactile sense. Basically the job is done in an unintrusive manner. Oh, and if anyone ever does make use of the 3-D option, that's fairly mean too.



Before 'pawning off' (an internationally unrecognised term for starting a game) you should make use of the numerous pull-down menus

## JUDGEMENT

Until a computer chess partner comes along which can bring hypnotists, telepaths and rowdy fan club members to freak you out ; until the Amiga develops the ability to chuck the pieces across the screen in a fit of pique when it loses and then blame the loss on the weather or FIDE, it'll be nothing to beat human contact. However, Chess Champion stands up well and provides an excellent game for beginner and experienced

amateur alike. It comes with a 300,000 byte library, is obviously well thought out and enthusiastically programmed and all this makes it almost a pleasure to be beaten by it. It's definitely a pleasure to beat it.

GRAPHICS	5
SOUND	N/A
INTELLECT	9
ADDICTION	7
OVERALL	77%

# MEGALAND

VISA

ALL OFFERS  
SUBJECT TO  
AVAILABILITY

## 0703 332225

12 MONTHS  
GUARANTEE ON  
ALL HARDWARE

M  
E  
G  
A  
L  
A  
N  
D

★ CLASS OF THE 90's ★  
Amiga A500 Educational Pack with Word Processing, Art and Design, Maxiplan 500, Publishers Choice, Amiga logo, the list goes on  
**OUR PRICE £545.00**

COMMODORE 64 WORLD CUP PACK  
Includes C64 Computer with cassette unit, two joysticks and features the amazing Adidas World Championship Football. Plus Beach Volley, Pro Tennis, Basketmaster etc.  
**OUR PRICE £149.50**

COMMODORE 64 LIGHT FANTASTIC PACK  
Includes C64 Computer with cassette unit, Light Gun, 3D Glasses and ten games, plus Toolbox Tape with Art Package etc.  
**OUR PRICE £149.50**

SOFTWARE  
ALL CURRENT  
TITLES  
48 HOUR  
DELIVERY  
P.O.A.

● ALL PRICES INCLUDE VAT ● ALL PRODUCTS CARRY UK SPECIFICATION ●

### SUMMER SIZZLER

**BATMAN PACK ● FLIGHT OF FANTASY ONLY ★ £299 Inc VAT ★ ONLY**

When you purchase any 10 titles at £9.95 each from the following selection:

- |                      |                 |                          |                        |
|----------------------|-----------------|--------------------------|------------------------|
| 1. Microprose Soccer | 7. Dominator    | 13. Saint & Greavsie     | 19. Galaxy Force       |
| 2. Battle Valley     | 8. Cybernoid II | 14. Espionage            | 20. Archipelagos       |
| 3. Star Blaze        | 9. Frost Byte   | 15. Exolon               | 21. Blasteroids        |
| 4. Running Man       | 10. Mouse Trap  | 16. Knight Orc           | 22. Cruncher Factory   |
| 5. Warp              | 11. Ice Hockey  | 17. President is Missing | 23. Pacland            |
| 6. Eye of Horus      | 12. Slayer      | 18. Thai Boxing          | 24. Karting Grand Prix |

You also get the following items free:  
Mouse Mat ● Dust Cover ● Joystick ● 10 Blank Disks

(Titles may change subject to stock without notice)

### ACCESSORIES

Monitor Stands from .....	£16.95
3.5" Blank Disks from .....	70p each
5.25" Blank Disks from .....	70p each
3.5" Disk Boxes from .....	£1.95
5.25" Disk Boxes from .....	£6.95
Printer leads from .....	£4.95
Dustcovers for printers and monitors from .....	£4.95

*We stock a full range of joysticks prices start from a low £3.95  
Designs include Konix, Quickshot, Cheetah and Cruisers.  
We have the following software offers:*

Kindwords ..... £44.95

- ★ Spritz Paintpack .....£9.95 Normally .....£29.95 ★
- ★ Superplan Spreadsheet .....£69.95 Normally .....£99.95 ★
- ★ Superbase Personal II .....£69.95 Normally .....£99.95 ★
- ★ Superbase Professional.£149.95 Normally .....£249.95 ★

### STAR PRINTERS

LC10 Mono 9 pin 144cps .....	£148.95
LC10 Colour 9 pin 7 colours.....	£194.95
LC2410 24 pin 170cps .....	£239.95
XB2410 24 pin 240 cps .....	£448.31
with colour kit .....	£489.95
XB2415 15" carriage .....	£590.51
Printer Ribbons for Star Printers from .....	£4.95
Laser Series.....	P.O.A.

Auto Sheet Feeders available on order

### PANASONIC PRINTERS

KXP1081 9 pin 120 Cap. NLQ .....	£138.00
KXP1124 24 pin 120 Cap. NLQ .....	£285.00
KXP1540 wide carriage .....	P.O.A.

### EPSON PRINTERS

Epson LX850 9 pin .....	£210.00
Epson LQ550 24 pin .....	£310.00

### OTHERS

Seikosha SP180 .....	£118.00
Canon PW1080 .....	£139.00
Citizen 120D .....	£124.95
Citizen HQP40 .....	£299.00
Amstrad DMP3160.....	£119.00

### MONITORS

1084SD Stereo Colour .....	£247.50
8833 Stereo Colour .....	£265.00

### DRIVES AND RAM EXPANSIONS ETC

A501 RAM Expansion .....	£89.00
512 RAM Expansion .....	£85.00
MDC 30 Ext. 3.5" Drive .....	£79.00
A1010 Ext. 3.5" Drive .....	£85.00
Cumana CAS354 Ext. Drive.....	£79.00
C64 1541 C11 Ext. 5.25" .....	£120.00
A590 20Mb Hard Disk.....	£375.00
1352 Mouse .....	£29.95
IBM Handy Mouse.....	£34.00
Amiga 2300 Genlock.....	£208.10
Genius Mouse IBM.....	£38.95
Spike Surge Protector.....	£10.95

To: 42-44 Millbrook Road East, Southampton

I wish to order.....

I enclose a cheque/PO for £ ..... Inc. VAT

Or charge my Access/Visa No. .... Exp. Date .....

XXXXXXXXXXXX

Name ..... Signature .....

Address .....

Postcode ..... Tel. No: .....

Prices correct on date going to press

AF

● DELIVERY CHARGE £10 COURIER ● ALL PRICES CORRECT AT GOING TO PRESS ●

★ CLASS OF THE 90's ★  
Amiga A500 Educational Pack with Word Processing, Art and Design, Maxiplan 500, Publishers Choice, Amiga logo, the list goes on  
**OUR PRICE £545.00**

COMMODORE 64 WORLD CUP PACK  
Includes C64 Computer with cassette unit, two joysticks and features the amazing Adidas World Championship Football. Plus Beach Volley, Pro Tennis, Basketmaster etc.  
**OUR PRICE £149.50**

COMMODORE 64 LIGHT FANTASTIC PACK  
Includes C64 Computer with cassette unit, Light Gun, 3D Glasses and ten games, plus Toolbox Tape with Art Package etc.  
**OUR PRICE £149.50**

MEGALAND CAN ALSO SUPPLY A COMPLETE RANGE OF PERSONAL COMPUTERS INCLUDING AMSTRAD, COMMODORE, HYUNDAI AND OLIVETTI P.O.A.



Where can that platform have come from? A little magic, perhaps...



The exit! Now where's the key? Oh no! Back to the start.

### LASTING INTEREST

Each screen of *Fire and Brimstone* is a puzzle in itself, requiring thought and dexterity to complete. Reaching the end of the level is one thing, but successfully finding all the sections of the key and escaping is another matter. Fail and it's back to the beginning again. Spread this over nine worlds and you have weeks of compulsive and addictive playing ahead.

# FIRE AND BRIMSTONE

MICROPROSE £24.99 ■ Joystick

Electronic Arts gave a hint of what it might be like to act as a deity with their God-simulator *Populous*, but what of the hellfire and mayhem that the Norse gods enjoyed? Microprose have stepped in to allow you to enter the raucous and violent world of Thor, God of thunder, law and order – a strange combination, but in legend anything can happen.

The land of the Norse gods consists of nine realms – from the worlds of Asgard, home of the gods, through Midgard (our Earth) to the dark realms of Muspell, home of the Dark Elves. Deeper down than this abominable world is Nifheim, home of the evil goddess Hel, controller of all the world's most evil monsters.

For generations Hel has been a nuisance, causing mayhem and disorder in the lower realms, but recently her powers have been spreading further and further afield. The people of Midgard are being made to suffer at the hands of her demons as she grasps for more and more power. The gods have decided – it must stop.

You take the role of Thor in his quest as nominated adventurer in the battle to defeat Hel. Your quest begins in Alfheim, where witches and ogres under the power of Hel will attack you. To gain access to Vanaheim, and



Oooh! Ah! Hee! Ouch! That's a tad on the warm side!

### GRAPHICS AND SOUND

The graphics are very colourful, and have been designed with tongue firmly in cheek. Thor, instead of being a huge strapping warrior, is a dinky little fellow with a bright red beard! The other creatures have a similarly cute appearance, and combined with the detailed and atmospheric scenery give the game a very polished appearance. The sound is of a slightly lower standard, however – consisting of a racy, but inappropriate tune and a few thin and weak spot effects. Where are the grunts of battle and the cataclysmic sound of magic spell being cast? Not here, I'm afraid.



There's a piece of key. Oops! An ogre. I wonder if he's seen Thor...

thence the other levels, you must find the sections of key that Hel has hidden in an attempt to protect herself. Once the key is complete you can battle through

the realm until you reach the exit, which is on the right-hand side.

Hel likes nothing more than a battle, so to taunt Thor she has placed magic potion bottles throughout the realm which are uncovered by killing various creatures on your path. Spells such as lightning and bridge-building will come in useful when the odds looked stacked against you. If you fight well enough, you will reach the realm of Nifheim, where Hel herself is waiting. **Maff Evans**

### JUDGEMENT

Capcom's *Ghosts 'n' Goblins* made it credible to portray mystical worlds in a 'cute' manner without being laughed out of the software market. *Fire and Brimstone* follows this structure well, managing to recreate the feel of Capcom's classic but without ripping off the game so that it can be dismissed out of hand as a simple arcade clone. Thor's quests are portrayed in an amusing and enjoyable way that should appeal greatly to those with a love for the mystical and a sense of humour.



A nice farmhouse. This is the last friendly place that Thor will see for a good long while.

GRAPHICS	8
SOUND	5
INTELLECT	4
ADDICTION	7
OVERALL	81%

# X-COPY II v2.4

X-COPY II is the ultimate disc duplication system for your Amiga



**Designed specifically for your Amiga...**

- ❖ The most comprehensive back-up facility
- ❖ Mouse controlled
- ❖ Also backs up ST, IBM etc
- ❖ Adapts itself to any configuration
- ❖ Checks discs for errors
- ❖ Formats discs in 36 seconds
- ❖ Optimises data, re-organises files for faster loading
- ❖ Full update service

**AVAILABLE NOW ONLY £29.99 + £1.00 POSTAGE & PACKING.**

X-COPY II is a hardware & software package. Although it will work happily on a single drive system, superior results can be achieved with an external disc drive.

1988 COPYRIGHT ACT. SIREN SOFTWARE NEITHER CONDONES NOR AUTHORISES THE USE OF ITS SOFTWARE FOR THE REPRODUCTION OF COPYRIGHTED SOFTWARE. THE FACILITIES OFFERED BY X-COPY II ARE INTENDED TO BACK UP USERS OWN SOFTWARE, PD SOFTWARE & OTHER SUCH PROGRAMS WHERE PERMISSION HAD BEEN EXPLICITLY GIVEN. IT IS ILLEGAL TO MAKE COPIES OF COPYRIGHTED MATERIAL WITHOUT THE PERMISSION OF THE COPYRIGHT HOLDER.

**X-COPY II IS THE BEST, GUARANTEED**

**OUR GUARANTEE:-** At time of purchase, if you can find a program that is more powerful than X-COPY II, we will refund your money.

## Ordering x-copy II

Access/Visa orders can be placed by telephoning 061 228 1831. For mail order, fill in the order form below and send with a cheque or postal order to:- Siren Software, 84-86 Princess St. Manchester M1 6NG. England.



NAME .....

ADDRESS .....

# THE POWER BREAKS THROUGH...

# AMIGA ACTION REPLAY™

**ONLY**  
**£59.99**  
**POST FREE**

**THE WORLD'S  
MOST POWERFUL  
FREEZER-UTILITY  
CARTRIDGE IS HERE**

**JUST LOOK AT THE UNMATCHED RANGE OF FEATURES**

- **AMIGA ACTION REPLAY SIMPLY PLUGS INTO THE EXPANSION PORT OF YOUR AMIGA 500 AND GIVES YOU THE POWER TO FREEZE MOST ANY PROGRAM, THEN YOU CAN:-**
- **SAVE THE ENTIRE PROGRAM IN MEMORY TO DISK**  
Special compacting techniques enable upto 3 programs to fit on one disk. Unique FDOS power means that the programs reload at upto 4 TIMES FASTER than Amiga Dos - even independantly of the cartridge.
- **UNIQUE INFINITE LIFE/TRAINER MODE**  
Allows you to generate more and even infinite lives, fuel, ammo etc. Perfect as a trainer mode to get you past that "impossible" level. Very easy to use.
- **SPRITE EDITOR**  
The full sprite editor allows you to view/modify the whole sprite set including any 'attached' sprites.
- **VIRUS DETECTION**  
Comprehensive virus detection and removal features to protect your software investment. Works with all presently known viruses.
- **SAVE PICTURES AND MUSIC TO DISK**  
Pictures and sound samples can be saved to disk. Files are IFF format suitable for use with all the major graphic and music packages.
- **SLOW MOTION MODE**  
Now you can slow down the action to your own pace. Easily adjustable from full speed to 20% speed. Ideal to help you through the tricky parts!
- **RESTART THE PROGRAM**  
Simply press a key and the program will continue where you left off.
- **FULL STATUS REPORTING**  
At the press of a key now you can view the machine status. Including Fast Ram, Chip Ram, Ramdisk, Drive status, etc.

## **PLUS THE MOST POWERFUL MACHINE CODE FREEZER/ MONITOR**

**MORE FEATURE THAN YOU COULD EVER NEED. HERE ARE JUST SOME;**

- Full M68000 Assembler/Disassembler
- Full screen editor
- Load /Save block
- Write string to Memory
- Jump to specific address
- Show Ram as text
- Show Frozen picture
- Play resident sample
- Show and edit all CPU registers and flags
- Calculator
- Help command
- Full search feature
- Unique Cutom Chip Editor allows you to see and modify all chip registers-even write only registers
- Notepad
- Disk handling - show actual track, Disk Sync pattern Etc.
- Dynamic Breakpoint handling
- Show memory as HEX, ASCII, Assembler, Decimal
- Copper Assemble/Disassemble.

**REMEMBER AT ALL TIMES YOU ARE INTERROGATING THE PROGRAM IN IT'S "FROZEN" STATE WITH ALL MEMORY AND REGISTERS INTACT.-INVALUABLE FOR THE DE-BUGGER OR JUST THE INQUISITIVE!**

**HOW TO GET YOUR AMIGA ACTION REPLAY...**

**TELEPHONE (24 Hrs) - 0782 744707 - CREDIT CARD ORDERS ONLY**

WE WILL DESPATCH YOUR ORDER QUICKLY & EFFICIENTLY TO ENABLE YOU TO START RECEIVING THE BENEFITS OF YOUR PURCHASE WITHIN DAYS, NOT WEEKS.

ORDERS NORMALLY DESPATCHED WITHIN 48Hrs.

ALL CHEQUES/POSTAL ORDERS MADE PAYABLE TO...

**DATel ELECTRONICS LTD.,**

**GOVAN RD., FENTON INDUSTRIAL ESTATE, FENTON, STOKE-ON-TRENT, ST4 2RS, ENGLAND**

**TECHNICAL/CUSTOMER SERVICE 0782 744324**



# D A TEL ELECTRONICS



## AMIGA PRO SAMPLER STUDIO II + DATEL JAMMER

**STEREO  
SAMPLING**

- A top quality stereo sampling system at a realistic price.
- The NEW Sampler II software has been completely re-written in 100% Machine Code and incorporates faster routines, bigger displays and a host of new editing features such as Cut, Copy, Insert, Replace, Mix, Erase, etc.
- Separate zoom windows and controls for left and right channels.
- Multi-bank facilities for 1 Meg users.
- Stereo lock control for ease of use.
- Adjustable trig record level and sound monitor.
- Separate buffer for editing waveforms and improved wave-editor with instant update.
- Save files in Raw or single, multi-octave IFF format.
- Envelope control panel for ramping up and down re-scale amplitude, noise filter and scan waveform.
- On screen display of filenames sample rate, length, etc.
- Inputs for microphone or line 1/4" jack and DIN connections

**ONLY £79.99 PLEASE STATE A500/1000/2000**



## GENISCAN GS4500 AMIGA

● An easy to handle Handy Scanner featuring 105 mm scanning width and 400 dpi resolution enables you to reproduce graphics and text.

- Adjustable switches for brightness/contrast levels. Printout for Epson compatibles.
- Powerful partner for DTP that allows for cut and paste editing of images etc.
- Geniscan gives you the ability to easily scan images, text and graphics.
- Save images in suitable format for most leading packages including PHOTON PAINT, DELUXE PAINT, etc.
- Package includes GS4500 scanner, Interface and Scan Edit software.
- Unmatched range of edit/capture facilities simply not offered by other scanners at this unbeatable price.

**SPECIAL OFFER COMPLETE WITH PHOTON PAINT  
FOR ONLY £169.99 INCLUDING HARDWARE/SOFTWARE**

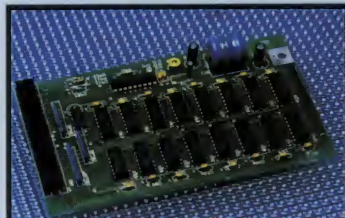

## 512K RAM EXTENSION CARD

- If you can obtain your own Ram chips, we can supply the card.
- Accepts 16 x 41256 D Rams.
- Available with/without clock option.
- Switch disable feature.

**ONLY £19.99**

**ONLY £29.99**

FOR VERSION WITH  
CLOCK/CALENDAR  
N.B. THESE PRICES DO NOT INCLUDE  
RAM CHIPS.

## REPLACEMENT MOUSE



- High quality direct replacement for mouse on the Amiga.
- Teflon glides for smoother movement.
- Rubber coated ball for minimum slip.
- Optical system counting - 500/mm.

Special offer - free mouse  
mat + mouse house  
(worth £7.99)

**ONLY £29.99  
COMPLETE**

## EXTERNAL 3.5" DISK DRIVE



- Top quality fully compatible drive mechanism.
- Throughport allows daisy-chaining other drives.
- 1 meg unformatted capacity.
- Good length cable for positioning on your desk etc.
- Comes complete with its own On/Off switch.

**NEW LOW PRICE  
ONLY £74.99**



**NEW**

## BOOT BLOCKER

- NOW YOU CAN END YOUR VIRUS PROBLEMS!
- Plugs into Amiga Disk Drive Port.
- Protects both internal and all external drives from virus damage.
- Switch to enable/disable protection.
- Can be left permanently installed.
- Works to with all known Boot Block Viruses.
- Start to protect your software investment now.

**ONLY £14.99**



## MIDIMASTER

- Full Midi Interface for A500/1000/2000 (please state model).
- Midi In - Midi Out x3 - Midi Thru.
- Compatible with all leading Midi packages.
- Fully Opto isolated.

**ONLY £34.99 INC. 2 FREE MIDI CABLES**



## MICROMIDI

- Fully compatible Midi Interface for A500/2000.
- Midi In - Midi Out - Midi Thru.
- Fully Opto isolated.

**ONLY £24.99**

**HOW TO GET YOUR ORDER FAST...**

**TELEPHONE (24 Hrs) - 0782 744707 - CREDIT CARD ORDERS**

WE WILL DESPATCH YOUR ORDER QUICKLY & EFFICIENTLY TO ENABLE YOU TO START RECEIVING THE BENEFITS OF YOUR PURCHASE WITHIN DAYS, NOT WEEKS. ORDERS NORMALLY DESPATCHED WITHIN 48 Hrs. UK ORDERS POST FREE/EUROPE ADD £1/OVERSEAS ADD £3. PRICES AND SPECIFICATIONS CORRECT AT TIME OF PRESS AND SUBJECT TO CHANGE WITHOUT NOTICE. CALLERS WELCOME - Please reserve goods by telephone prior to visit. ALL CHEQUES/POSTAL ORDERS MADE PAYABLE TO...

**D A TEL ELECTRONICS LTD.,**

**GOVAN ROAD, FENTON INDUSTRIAL ESTATE, FENTON, STOKE-ON-TRENT, ST4 2RS, ENGLAND**  
TELEPHONE SALES ONLY 0782 744707 FAX 0782 744292 TECHNICAL/CUSTOMER SERVICE 0782 744324

# MORE MEMORY POWER!

## NOW YOU CAN ADD AN EXTRA 512K OR EVEN 2 MEGS TO YOUR AMIGA A500

**UNIQUE FASTMEM/  
CHIPMEM OPTION\***

# PRO-RAM PLUS™

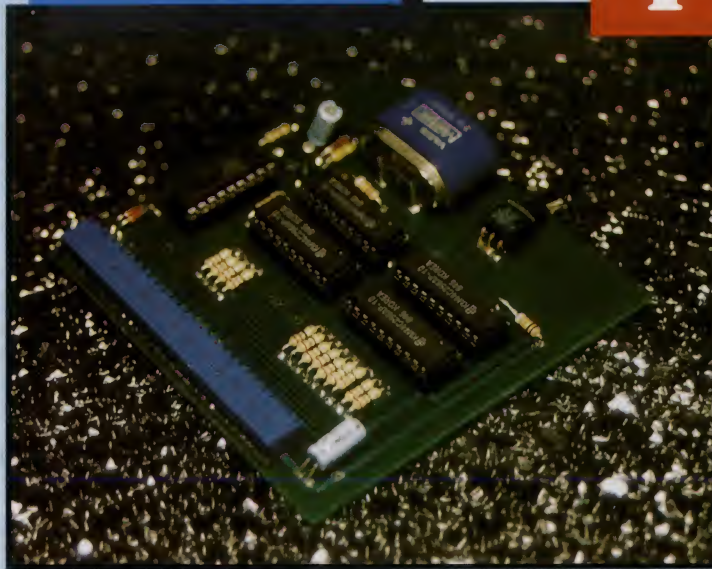

- THE FIRST RAM UPGRADE CARD TO OFFER THE UNIQUE FASTMEM OR CHIPMEM OPTION AT THE FLICK OF A SWITCH\*. NOW YOU CAN HAVE THE EXTRA SCREEN HANDLING ABILITY OF THE A2000 - PLUS LOTS MORE!!
- Simply plug into your Amiga A500 and upgrade to a full 1 Meg in minutes!!
- Features the latest 1 Meg DRams. Low chip count means very low power consumption.
- Top quality high grade PCB and connector to give unmatched reliability.
- Switch to enable/disable plus "ChipMem" option\*.
- Now you can run ALL Amiga 1Meg programs.
- Also available with clock/calendar option.
- Easily fitted into the slot under your A500 - does not affect warranty.

**ONLY £49.99** STANDARD VERSION  
**£59.99** FOR CLOCK VERSION

# RAM-MASTER II™

- IF YOU NEED EVEN MORE POWER THEN THE RAM-MASTER II™ IS FOR YOU!!
- Adds an extra 2 Megs to your A500 (giving a total free memory of 2.3 Megs).
- Uses the latest 1 Meg DRams resulting in extra low power consumption.
- Switch to enable/disable plus "ChipMem" option\*.
- Complete with onboard clock/calendar.
- Top quality connections used throughout.
- High grade PCB.
- Easily fitted into the slot under your A500 - requires no soldering (the cover of your A500 must be removed for fitting "plug in" connector #)

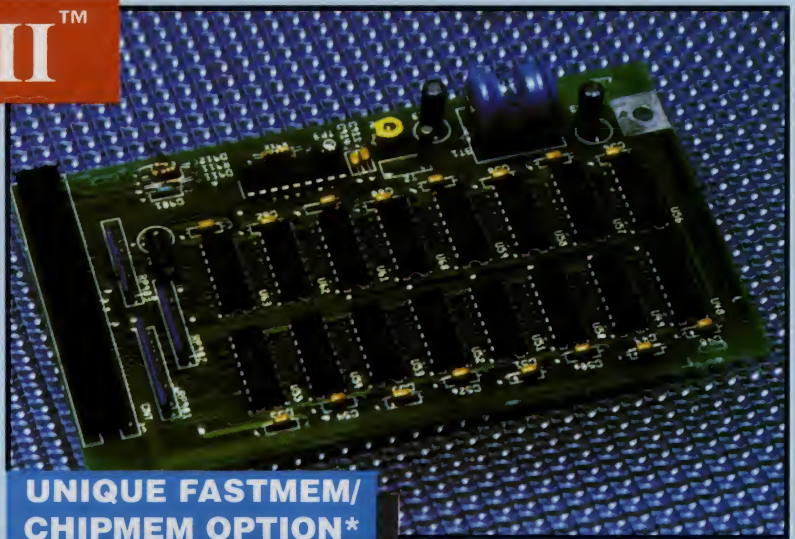

**UNIQUE FASTMEM/  
CHIPMEM OPTION\***

**ONLY £169.99** WITH 2 MEGS OF RAM  
**ONLY £59.99** FOR CARD WITHOUT RAM

**\*CHIPMEM OR FASTMEM OPTION  
WITH FREE 1 MEG OR 2 MEG DEMO DISKS**

- Yes, if your Amiga was bought in the last 12 months and has KICKSTART 1.3 then it probably has the 'fatter' 1 Meg AGNUS Chip. Even though this was not publicised by Commodore, those machines with the '02' AGNUS, have 1 Meg Chip Ram ability. Both the PRORAM PLUS™ and the RAM-MASTER™ boards can be configured to give 512K of extra Chip Memory instead of Fast Memory at the flick of a switch.
  - With 1 Meg of Chip Memory you can do lots of things previously only available on the A2000 - more HiRes screens, multitasking graphics programs, CAD, DTP, larger sound samples, etc., etc.
  - Remember, no other cards offer this unique feature.
- \* One simple soldering job is required to enable the "ChipMem" feature.  
# Opening your A500 may invalidate your warranty.

**EVEN IF YOU DON'T HAVE THE LATEST AGNUS CHIP THE PRORAM PLUS™ AND RAM-MASTER™ WILL STILL GIVE YOU THE FASTRAM OPTIONS OFFERED BY OTHER BOARDS AND AT AN UNBEATABLE PRICE - YOU JUST CAN'T BEAT THESE DEALS!!**



# FREE!

## HOW TO GET YOUR ORDER FAST...

**TELEPHONE (24 Hrs) - 0782 744707 - CREDIT CARD ORDERS**

WE WILL DESPATCH YOUR ORDER QUICKLY & EFFICIENTLY TO ENABLE YOU TO START RECEIVING THE BENEFITS OF YOUR PURCHASE WITHIN DAYS, NOT WEEKS. ORDERS NORMALLY DESPATCHED WITHIN 48 Hrs. UK ORDERS POST FREE/EUROPE ADD £1/OVERSEAS ADD £3. PRICES AND SPECIFICATIONS CORRECT AT TIME OF PRESS AND SUBJECT TO CHANGE WITHOUT NOTICE. CALLERS WELCOME - Please reserve goods by telephone prior to visit. ALL CHEQUES/POSTAL ORDERS MADE PAYABLE TO...

**DATEL ELECTRONICS LTD.,**

**GOVAN ROAD, FENTON INDUSTRIAL ESTATE, FENTON, STOKE-ON-TRENT, ST4 2RS, ENGLAND**  
TELEPHONE SALES ONLY 0782 744707      FAX 0782 744292      TECHNICAL/CUSTOMER SERVICE 0782 744324



# A NEW WORLD OF POWER

THE ANSWER  
TO YOUR  
DISK  
DUPLICATION  
PROBLEMS

FOR ONLY

£34.99

THE

## SYNCR0 EXPRESS II

IS HERE!

● SYNCR0 EXPRESS IS A HIGH SPEED DISK DUPLICATION SYSTEM THAT WILL PRODUCE COPIES OF YOUR DISK IN AROUND 50 SECONDS!!

● Syncro Express requires a second drive & works by controlling it as a slave device & ignoring the ST or Amiga disk drive controller chip whereby high speeds & great data accuracy are achieved.

● Menu driven selection for Start Track/End Track - up to 80 tracks. 1 side, 2 sides.

● Very simple to use, requires no user knowledge.

● Also duplicates other formats such as IBM, MAC etc.

● Ideal for clubs, user groups or just for your own disks.

● No more waiting around for your disks to copy.

● Probably the only duplication system you will ever need!

### THE LATEST CUSTOM LSI CHIP TECHNOLOGY

By using an on-board Custom LSI Chip, Syncro Express has the power to transfer an MFM image of the original disk directly to your blank disk - quickly, simply and without any user knowledge. One external disk drive is required\*.



**SYNCR0 EXPRESS IS AVAILABLE FOR BOTH THE ST AND AMIGA SYSTEMS - PLEASE STATE WHICH REQUIRED WHEN ORDERING**

#### WARNING 1988 COPYRIGHT ACT WARNING

Datel Electronics Ltd., neither condones nor authorises the use of its products for the reproduction of copyright material.

The backup facilities of this product are designed to reproduce only software such as Public Domain material, the users own programs or software where permission to make a backup has been clearly given. It is illegal to make copies, even for your own use, of copyright material, without the express permission of the copyright owner, or the licensee thereof.

If you don't have a second drive we can supply  
**SYNCR0 EXPRESS** together with a drive for  
**ONLY £104.99 (AMIGA)**  
**ONLY £119.99 (ST)**

HOW TO GET YOUR **SYNCR0 EXPRESS II**

TELEPHONE (24 Hrs) - **0782 744707** - CREDIT CARD ORDERS

WE WILL DESPATCH YOUR ORDER QUICKLY & EFFICIENTLY TO ENABLE YOU TO START RECEIVING THE BENEFITS OF YOUR PURCHASE WITHIN DAYS, NOT WEEKS.

ORDERS NORMALLY DESPATCHED WITHIN 48 Hrs. ALL CHEQUES/POSTAL ORDERS MADE PAYABLE TO...



**DATEL ELECTRONICS LTD.,**



GOVAN ROAD, FENTON INDUSTRIAL ESTATE, FENTON, STOKE-ON-TRENT, ST4 2RS, ENGLAND  
TECHNICAL/CUSTOMER SERVICE 0782 744324

ATARI ST  
AMIGA  
IBM P.C. AND  
COMPATIBLES

THE ARCADE EXPLODES!

AMSTRAD CPC  
SPECTRUM  
COMMODORE 64  
SEGA

# FIRE & FORGET™

THE DEATH CONVOY™

# II

As the pilot of an all powerful combat vehicle, you are engaged in the hot pursuit of terrorists. Go into combat and be confronted by enemies as different in their appearance as in their combat techniques. The ability to take to the air will be your strength, use this to out-maneuvre the enemy. Pick up weapons, ammunitions and fuel. You'll have to work your way through the entire convoy and destroy the leading vehicle, before the ULTIMATE EXPLOSION.

NUCLEAR threat... Stop. DESTROYER CONVOY detected... Stop. Wipe out the TERRORISTS.. Stop. Scientists in DANGER... Stop. IMMEDIATE ACTION... End of transmission.

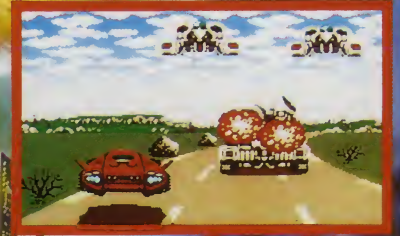

QUICK REFLEXES, SPEED, INGENUITY AND NERVES OF STEEL ARE REQUIRED TO OBLITERATE THE OPPRESSOR.

**SUPER FAST 3D ACTION.**  
**15 INGENIOUS MUSICAL SCORES.**  
**50 DIFFERENT TYPES OF ENEMIES.**  
**5 SQUAD LEADERS TO DESTROY.**  
**BONUS LEVELS**  
**A MULTITUDE OF ARMS AND AMMO**  
**LAND AND AIR COMBAT.**



**A FABULOUS  
ADAPTATION  
OF THE  
ARCADE GAME**



4TH STANNETS. LAINDON NORTH TRADE CENTRE.  
BASILDON ESSEX. SS156DJ. PHONE: (0268) 541126

Copyright © 1991 Titus Software Corporation. All rights reserved. Fire & Forget II, Titus and the Titus logo are registered trademarks of Titus Software Corporation. All other trademarks acknowledged. Product description and screen shots represent Amiga version; others may vary. Titus reserves the right to make modifications to the product at any time and without notice. Made in France.



# GAMES Workshop

Games creation systems for the Amiga have been thin on the ground, to say the least. What packages do exist have unfortunately proved to be rather too limited – Palace's *Shoot-em-up Construction Kit* was little more than 'edit the sprites, but the gameplay remains the same', while Microdeal's *Talespin* adventure writer failed to impress at all. In complete contrast, ST users have enjoyed two of the most successful games writing utilities to date – namely Mandarin's *STOS* and Incentive's *STAC*.

While Incentive still refuse to bow to public pressure and produce an Amiga version of *STAC* (come on Incentive, you know it makes sense!), Mandarin at least have proved that they listen to what the user wants with the release of an Amiga version of *STOS*. Since its announcement last year, Amiga users have been waiting patiently (the package has been delayed over eight months!) for what has been called the most important Amiga games-related release ever. Now, in what seems rather a subdued manner, Mandarin have unleashed their most ambitious and eagerly awaited product; *AMOS* has arrived.

It's finally here – Mandarin's long-awaited *AMOS* has risen from the depths of vapourware to become a reality. **JASON HOLBORN** sorts out the facts from the hype.

## Introducing AMOS

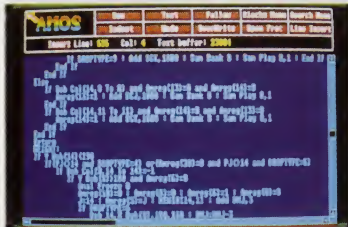

We must all have seen this screen a thousand times before. Yes folks, it's the **AMOS Program Editor**.

Although Mandarin would have you think otherwise, *AMOS* is primarily a programming language geared heavily towards the creation of arcade games. As well as the usual constructs and commands you'd expect from a modern BASIC, just about everything you've ever wanted to be able to do from BASIC is here – powerful sprite manipulation, sampled sounds, fast blitter objects, copper tricks to put even the most experienced demo coder to shame, ...and the list continues, and continues...

Most would have taken the easy option of porting *STOS* straight across onto the Amiga, but *AMOS* programmer Francois Lionet has done Amiga users proud with an implementation of his games writing system that promises to push the Amiga further than any other language has ever dared to try. Mandarin admit this was their original intention, but perfectionist Francois decided to start from scratch and take full advantage of the extra hardware that the Amiga has to offer.

**BELOW:** The **AMOS Configuration Editor** lets you customise your programming environment beyond belief. Just about everything can be customised with ease.



## MAKE MONEY WITH AMOS

The million-dollar question is undoubtedly 'Can *AMOS* be used to produce commercial-quality games?' Well, from what we've already seen of what *AMOS* is capable of, the answer seems undoubtedly 'Yes'. Mandarin already have at least one *AMOS* game in the pipeline in the form of *Cartoon Capers*, a fun little *Karate Kid* meets *Tom and Jerry* type beat-em-up. If you can produce a game of similar quality, Mandarin may even consider marketing your game. OK, we've heard that one before too, but Mandarin seem quite genuine about it.

So what restrictions are there on producing a game using *AMOS*? Once again, the answer is favourable – not a great deal. Although the *AMOS* package does not include a compiler, it is possible to produce stand-alone games that can be freely distributed without Mandarin's consent. All they ask is that you acknowledge them by stating that your game was written using *AMOS* – which is not an unreasonable request.

**BELOW:** Mandarin's soon-to-be-released *Cartoon Capers* – you'll never believe that it was written in what is basically BASIC!





**RIGHT:** The four sample games that are included with the AMOS package. As a demo of what AMOS is capable of, they certainly bode well for the future.



The AMOS package consists of two disks containing the AMOS BASIC interpreter, a number of utility programs (or 'accessories' as AMOS prefers) and four complete games produced entirely using AMOS.

The games consist of *Amasteroids* (no prizes for guessing that this is an *Asteroids* clone), *Magic Forest* (a rather nicely done platforms and ladders type of game), *Castle AMOS* (a mouse driven graphic adventure) and, last but not least, *Frog Leap* (a fun little educational game from Database Software's *Fun School* series). None is particularly earth-shattering, but as a demo of what AMOS is capable of they bode well for the future.

### BASICally Speaking

Calling AMOS a BASIC language may conjure up misconceptions for many people. The common image of BASIC is as a rather cumbersome and limited language that runs programs at a veritable snail's pace – all of which is true if you are used to using

“The language offers blisteringly fast operational speed with the ease and flexibility of use that you'd expect from other, more trendy languages”

AmigaBASIC! However, this is definitely not the case with AMOS.

AMOS BASIC is the heart of the AMOS system. The language offers blisteringly fast operational speed with the ease and flexibility of use that you'd expect from other, more trendy languages. The secret behind AMOS's speed and power is the way it has been implemented. Many other BASICs are held back because they rely heavily on the Amiga operating system to handle such things as screens, windows, drawing functions etc. Although the Amiga O/S is powerful, the one thing it most definitely isn't is fast.

AMOS achieves its phenomenal speed by bypassing much of the operating system, using instead its own custom routines for most of its commands. The upshot of this is that AMOS isn't Intuition-based; instead, it creates and uses its own custom views that are not linked to Intuition, therefore making it impossible to

carry out operations such as depth arranging the AMOS screen with other screens. However, if you are writing games the first thing you would usually do is to dump the operating system, so the lack of Intuition support isn't much of a loss. I will probably be called a heretic and stoned for saying that!

As BASICs go, AMOS is pretty well endowed. AMOS BASIC offers many modern structured programming constructs such as do...loop, if...then...else, while...wend, etc. Sections of code can be partitioned off into procedures that can be collapsed and expanded from within the AMOS editor, in the same manner as GFA BASIC. AMOS also provides extensive disk handling support, allowing both sequential and random access files to be easily handled. For maths freaks, AMOS offers a wide variety of the more commonly-needed mathematical functions. Surprisingly, AMOS doesn't use its own custom maths routines, preferring instead to use the standard Amiga maths routines held within *mathtrans.library*.

## AMOS ACCESSORIES

Just providing a programming language isn't enough for creating games. For starters you'll need a utility to design all your game's sprites, then of course you need a music package for composing the sound track, a utility for designing the background graphics – and a sampler would come in handy for grabbing those digitised sounds. Although not everything is covered, AMOS provides a range of accessory programs to carry out many of these tasks.

Most immediately useable of these is the AMOS Sprite Designer. This little package is an impressive little chappie that will enable you to create animated BOBs (sprites) using any number of colours or of any resolution. As well as the usual editing functions, you can flip your sprite, rotate it and stretch it to your heart's delight.

Also included is the AMOS Map designer, called TAME. TAME allows you to create massive

maps built up from four different blocks (16 pixels by 16, 16x32, 32x16 or 32-pixel-square) cut from any IFF picture source.

Surprisingly, AMOS doesn't include a music editor like its ST predecessor. For reasons unknown, Mandarin plan to release one as a separate product. As it is, you're going to need either *Sound Tracker*, *Game Music Creator* or *Aegis Sonix* if you want to add music to your creations. As the first two are PD, this isn't going to be too much of a hardship.

Last but not least, you're definitely going to need both a paint package such as *Deluxe Paint* (for producing most of the graphics for your games) and a decent sound sampler such as *MasterSound* (for digitising sound effects for the games). Once you've got hold of all of these, you're ready to produce that mega-game that has been pent up inside you for so long.

### Screen Scene

Multiple screens are pretty old hat these days, but AMOS takes them one step further. Because AMOS's screen handling is not tied to the constraints of Intuition, multiple screens can be created that are all part of the same view. This basically means that you can create a screen that is split into several subsections, each of which has its own resolution and colour palette. Even HAM and Extra Half Brite screens can be implemented with ease.

Pulling graphics into your own programs from a paint package such as *Deluxe Paint* has always been something of a ordeal from other BASICs, but AMOS makes the task a breeze. AMOS provides direct support for IFF graphics, thereby allowing any picture file to be pulled in from disk and displayed with a single command. It's nice to see that at least one BASIC finally addresses such an obvious failing of currently-available Amiga programming languages.

Copper tricks are an all-time favourite with demo and games programmers – we've all seen the coloured copper bars that seem to pop up in just about every demo these days. With AMOS, you can add these exciting effects to your own programs via the AMOS Rainbow



The AMOS Sprite editor is one of the most comprehensive programs of its type available – it certainly puts AmigaBASIC's ObjEdit to shame!



Creating multiple screen games is simple with the AMOS Map Editor, TAME. TAME allows the designer to cut blocks from any picture source.



command. Most exciting of all is AMOS's support for the copper co-processor. AMOS includes commands covering the complete copper instruction set, allowing you to achieve visual effects that were previously only possible from low-level hardware programming.

### BOB's Your Uncle

The secret of any game lies in the quality of its on-screen sprites, in terms of size, definition and quality of animation. Thankfully, much of the drudgery of incorporating animated sprites is handled by AMOS, so it's only left for you to decide how your sprites should behave.

AMOS supports both hardware and software sprites. Using what AMOS calls Computed Sprites, it is actually possible to display up to 64 hardware sprites on-screen simultaneously. Due to limitations of the Amiga hardware, hardware sprites are limited in both size and the number of colours they can use, so AMOS also supports the Amiga's unique blitter-based sprites, called BOBs. Although not as fast hardware sprites, the number of Blitter Objects you can use is limited only by memory.

Sprite animation is handled by AMOS's unique AMAL, a powerful animation programming language that allows AMOS to animate many on-screen objects at a phenomenal speed. AMAL can be used to animate just about anything, ranging from a simple sprite to an entire screen. The AMAL language includes its own subset of commands that run concurrently with the main AMOS program. This basically means that you don't have to worry about the movement of your sprites – as soon as the AMAL program is executed, AMOS runs it under interrupt. Even if you halt your program, your sprites will still continue to fly about the screen!

AMAL allows up to 16 sprites to be animated simultaneously, all of which have their own predefined patterns of movement. Using an animation language may sound daunting, but AMOS makes the task simple by providing a simple little utility that allows you to create movement paths by simply dragging the mouse pointer around the screen. Although this is not as comprehensive as Mandarin would have liked, the company does have plans to produce a fully-fledged AMAL editor which will be released into the public domain.

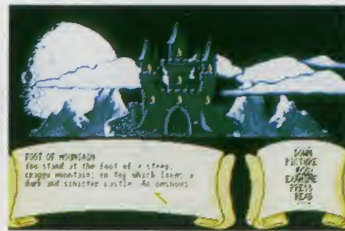

### Sound Complicated?

The Amiga's ability to play back digitised sounds is one of its greatest assets, and AMOS addresses this with an impressive range of sound commands that will enable you to add both musical sound tracks and sampled sound effects to your game creations. As an added advantage, AMOS treats the playing of such sounds as an independent task – even if you're playing a particularly complex piece of music, your AMOS program will still run at full speed.

Standard IFF sampled sounds can be pulled into a sample bank and then played using the AMOS Sam Play command. You can vary the playback rate and even loop samples. However, most exciting off all is AMOS's ability to play sound tracks under interrupt. If you're the owner of either *Sound Tracker*, Andreas Tadi's *Game Music Creator* or the popular *Sonix* program from Aegis, then AMOS will allow you to use your musical masterpieces within your own programs once they have been converted to AMOS format using the included conversion utility. Once you start playing your soundtrack, AMOS takes over and the task of running the music is handled automatically.

### Worth the Wait?

With over 500 commands to work with, providing a complete review of every aspect of AMOS is an almost impossible task – AMOS is just so powerful that you'll never stop finding new ways of applying its impressive range of commands and features. AMOS isn't just a BASIC language, it is the BASIC language for the Amiga – no other language will let you do so much with so little effort!

Within minutes you'll be achieving things that would have previously only have been possible from assembler – and even then, similar results would have taken you considerably longer to produce. No other Amiga programming language provides such a simple and direct method of getting the very most from everything the Amiga has to offer.

Although many have called AMOS a games creation system, it must be stressed that AMOS most certainly will not produce your game for you. AMOS is only a tool; what it can produce is limited only by the programming proficiency of the user. This is the case with any programming language – no matter how easy the

“ AMOS most certainly will not produce your game for you – what it can produce is limited only by the programming proficiency of the user ”

language may make the task of producing a game, it's down to the programmer to learn how to use the facilities that the language provides to produce the final product. If you think you will produce a commercial-quality game with AMOS within your first week of use, then you're more than a bit over-optimistic.

However, what AMOS aims to provide is a considerably easier way of achieving this final goal. Previously, the vast majority of time spent producing a game was wasted on sections of code that had absolutely nothing to do with the gameplay at all – handling the double buffering of screens, for instance. AMOS will happily handle such dirty work, allowing you to spend more time on the mechanics of the actual game itself.

It's fair to say that AMOS certainly isn't a jack of all trades. For serious applications programming, you're probably better off sticking with one of the more established languages such as GFA or HiSoft BASIC, but for producing programs that need to use ultra-fast graphics and animation, super-smooth scrolling and scintillating sound, there is really only one choice... and its name is AMOS.

### AMOS

£49.95 ■ All Amigas ■

Mandarin Software 0625 878888

## AMOS - THE FUTURE

Most would have rushed the product out and then sat back while the profits rolled in, but Mandarin have already announced a series of follow-up additions to further

enhance an already impressive product. First up is AMOS Sprites 600, which is actually being given away free of charge if you buy AMOS directly from Mandarin. As the name suggests, this pack consists of 600 different sprites which can be used freely within any of your AMOS-created games.

Most exciting of all must undoubtedly be AMOS 3D. AMOS 3D is a language extension that adds the power of 3D graphics to the existing AMOS system. With it you'll be able to incorporate solid 3D objects into your AMOS games and then manipulate them on screen in real time. Mandarin claim that the package will enable you to produce *StarGlider*-type games with ease. The product is backed up by a sophisticated 3D object editor which will allow you to create and edit 3D objects without all the usual hassles involved in such a complicated task.

Last but not least, there's the AMOS Compiler which is being worked on as we speak. This little baby will allow you to take an existing AMOS program and compile it to a super-fast stand alone program.

Both the AMOS Compiler and AMOS 3D are pencilled in for release later this year, so keep your eyes peeled for reviews of both of these products in a future issue of *Amiga Format*.



Argonaut eat your heart out! You too can create *StarGlider* quality games with the soon-to-be-released AMOS 3D.

# INTERNATIONAL 3D TENNIS

**INTERNATIONAL 3D TENNIS IS A REVOLUTIONARY NEW TENNIS SIMULATION. THE INNOVATIVE USE OF VECTOR GRAPHICS HAS CREATED A GAME WITH UNRIVALLED PLAYABILITY AND AN UNPARALLED NUMBER OF FEATURES.**

AUST. OPEN: MELBOURNE  
PRIZE MONEY: \$810000  
6 ROUNDS  
5 SETS ON CEMENT  
ENTER TOURNAMENT  
MONEY BREAKDOWN  
RESELECT TOURNAMENT



Screenshots various systems.



Individual format release dates may vary.

- Remarkable new 3D real time animation system.
- One or two player games.
- Four player ability levels – amateur, semi-pro, pro and Ace.
- View the game from any one of ten "camera" angles – infinite on ST and Amiga.
- Learn to play topspin and backspin balls.
- True control over the direction of your shots.
- T.V. tennis theme tunes.
- Any-time save option.
- 64 different computer opponents, with 16 skill levels.

- 72 tournaments to play in all based on real events with genuine court conditions and prize monies.
- 4 court surfaces – grass, clay, carpet and cement – each affecting game play.
- Digitised pictures (ST and Amiga)
- Digitised voice of real Wimbledon umpire (ST and Amiga).
- Choose which 22 tournaments to play in a full tennis season, against world class competition and aim to earn a million dollars!

• C64 • C64 DISK • SPECTRUM • AMSTRAD • AMSTRAD DISK • ST • AMIGA •

"This is fab...a breakthrough ...no-one could fail to be impressed."

**C&VG 94% C&VG HIT**

"It's smashing, ace and beats the competition...immense fun, demanding for novice and expert alike, the best sports game for ages."

**ZZAP! 94% ZZAP! SIZZLER**

**PALACE**

# pd UPDATE



Why not take a trip to the PD libraries? Heads off on a search for all the best PD has to offer with **RICHARD MONTEIRO.**

## FISH 336

The PD libraries are filled with quality games, but pulling together a decent collection can be a costly affair. However, Fish 336 contains three of the most addictive and compelling PD games you're likely to run into, all of which were written by the same prolific PD author, Anders Beijin.

Packed with three quality games and even a handy file requester for programmers, this disk is an absolute steal at the usual PD fee.

### CAR

Anyone remember *Super Sprint* in the arcades? What a game that was! I remember pumping pounds into what must have been one of the most addictive race games ever. Unfortunately, although the game was converted to most of the popular home micros of the time (including the Atari ST!), it failed ever to materialise on the Amiga (a shame, I say).

However suffer no longer, as *Car* is here. OK, it hasn't exactly got the most awe-inspiring title you could possibly come up with for a racing game, but the game-play is second to none. In true *Super Sprint* fashion, the game is a two-dimensional full-screen scrolling race game that boasts both an overscanned playing area and realistic sampled car sounds – the usual screeching tyres and revving engine noises.

The aim of the game is to gain the fastest lap times by throwing your street racer around any one of the ten available tracks.

However, someone ought to speak to the designers of the car you're driving as it seems to handle about as well as shopping trolley!

Of course, this should be of no great concern to such skilled gamers as yourselves!



ABOVE: *Super Sprint*? No, this is *Car*.

BELOW: Platform fun abounds in *Sys*.

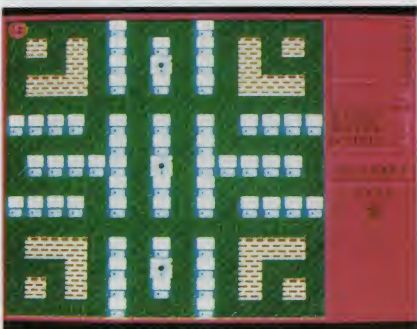

### MINIBLAST

A shoot-em-up game that not only multi-tasks, but also runs from Workbench? It can't be possible, surely? Once again, author Anders Beijin does it in style with *Mini-Blast*, probably the world's first Workbench-based arcade game.

There's not a great deal you can say about *Mini-Blast*. Looking like a cross between *Defender* and

*Scramble* (remember them?), the object of the game is pure and simple – shoot everything in sight.

Yep, it's time to unplug the brain and show no mercy as you blast everything to smithereens. As the instructions say – if it moves, shoot it and if it doesn't, then shoot it anyway!

### SYS

*Pengo* fans will love this one. *Sys* is a modern-day adaptation of that classic arcade game that sees you assigned the task of cleaning viruses from your *SYSOP*'s hard disk.

This certainly isn't going to be a picnic as those viruses aren't going to take it sitting down – they're after your blood, matey!

Who ever said PD games are limited? Whoever it was, take them out and shoot them! *Sys* offers fifty screens of frantic *Pengo*-like arcade action to keep you going. This is definitely destined to be a PD classic!

### FILEWINDOW

Last but not least, programmers will love this freely distributable file requester module. Anders' requester uses dynamically allocated memory to hold the file names so the only limitation is the amount of memory available.

Not only that, but the requester also includes a handy filter option to limit display of filenames to only ones with a specific extension (very useful). Even the ARP requester isn't a patch on this little baby!

## IFF2EX Fish 331

Ever wished you could display IFF pictures without first having to load them into a paint package or using one of the multitude of picture-viewing utilities? If so, then *IFF2Ex* could be the answer to your problems.

*IFF2Ex* takes a standard IFF picture, be it NTSC or PAL, overscanned, interlaced or what ever, and turns it into an executable program file. By simply assigning a tool icon to it, your picture can be viewed at any time by just clicking on its icon – no unnecessary disk swapping or external programs are needed as the picture contains its own picture-viewing code.

## STILLSTORE Fish 317

OK, *StillStore* sounds like just another slideshow program, but it is actually a very handy desktop video tool. The program loads and displays IFF images of any resolution interchangeably from a batch file. The user may then easily skip forward or backwards through one or more pictures in the list.

The program can be used 'on air' with no concern that a pull-down menu will suddenly appear in the viewable area. It also provides a precise cue for changing windows or screens.

## OCTALYZER Crazy Joe's Disk 259

We've all played with the endless variations of the now-infamous *Sound Tracker* utility, but none can compare with this latest arrival, *Octalyzer* – the world's first eight-channel *Sound Tracker* utility. *Octalyzer* is a sophisticated music composition tool that uses Amiga



Public Domain  
N.B.S. 132 Gunville Road, Newport,  
Isle Of Wight PO30 5LH  
Tel: (0983) 529594

THIS IS THE SMILE OF A PERSON WHO HAS EXPERIENCED  
THE N.B.S. PUBLIC DOMAIN SERVICE!



SPEED  
RELIABILITY

VALUE  
SERVICE

OUT NOW: PD UPDATE N<sup>o</sup> 4. Full Catalogue, Reviews, Discount  
Prices, Competitions, plus the exclusive N.B.S. Hot Club.

**A SELECTION OF THE LATEST TITLES  
TO OUR PUBLIC DOMAIN LIST**

- D180 SCOPEX MENTAL HANGOVER...A classic, fantastic mini-mega!
- D186 ANARCHY DEMOS...Great flashy demos inc COMA!!
- D192 BRUCE LEE SLIDESHOW...Digi piccys of the Kung Fu Hero.
- D190 N.B.S. DEMOS (May)...Latest demos inc RSI Cebit!!
- D194 F.D.S. DEMOS 6...(best with 1 Meg) The latest compilations.
- D195 F.D.S. DEMOS 7...of the best demos around, put together.
- D196 F.D.S. DEMOS 8...by Kolec of the F.D.S. Group
- D308 JOES SLIDESHOW 2...Nice digi piccys. Good show.
- D309 PHOTOMONTAGE 1...Another collection of digitised pictures.
- D310 PHOTOMONTAGE 2...using Digi-View Gold. A brilliant collection.
- D311 PHOTOMONTAGE 3...of high res stuff from UTOPIA.
- D510 THE RUN...Tobias Richter's police chase anim. (1 Meg!)
- M057 TRIUMPH MUSIC 5...Great tunes ripped from demos.
- ALCATRAZ Mega Demo 4 (3 disks) Brand new demo, brilliant.
- NETWORK Demo 3 (2 disks) 1 Meg, highly rated.
- XXX RATED (Please state over 18)
- X110 FRAXION HORROR...Absolutely brilliant horror disk!!
- X111 HORNY MOUSE SLIDE-SHOW (part 1) More of those...girls!!
- X112 HORNY MOUSE SLIDE-SHOW (part 2) and even more bits!!
- X113 BODY TALK...(1 Meg, 2 Drives) Utopia's high res goodies.
- X114 BUSTERS!!...Makes Showering girls Sunday School pupils!!
- GAMES**
- G112 FRANTIC FREDDIE...Recreation of C64 hit game
- G113 COMPUTER CONFLICT...SEUCK creation...but its good!!

ALL ABOVE DISKS ONLY £1.35 (WHY PAY MORE)  
PLEASE ADD 50p P&P TO TOTAL

3 1/2" DS/DD Guaranteed DISKS  
65p EACH BULK DISCOUNTS!

**Mouse Mats:**

Soft, boxed, red, blue, grey, £3.25

**STAR LC10 (MK1 & MK2)**

PRINTER RIBBONS  
Black £3.30 Colour £5.75

**Custom 3 1/2" Disk Labels**

200 for £5.00 1000 for £20.00

Cheques/PO payable to N.B.S. Please include  
50p post and packing to total order

European orders welcome! Eurocheques or  
cash only please add £2.00 for postage

World orders... please enquire

For catalogue please send 9" x 4" (min)  
stamped (£20p) self addressed envelope

**LIFE MEMBERSHIP  
LIBRARY AND  
FREE P.D.  
ONLY £1**

**PRICES;**  
1-5 = £1.50  
6-10 = £1.25  
11+ = £1.00  
per disk

**PREMIER P.D.**

**SAYS NO TO PROFIT, AND GIVES  
IT BACK TO OUR MEMBERS!  
PRICES STATED INCLUDE DISK  
SUBTRACT 50p IF YOU SUPPLY DISKS  
Send cheques or P.O.s to:  
PREMIER P.D. 15 CROXTETH Dr.  
RAINFORD, MERSEYSIDE, WA11 8JZ.**

**NEW IMAGE P.D.**

● PACKS OF 5 DISKS ONLY £8.50 EACH + FREE GIFT ●

**Pack 1 - Games Galore 1** → Blizzard, Breakout + C.Kit, Tennis  
(1 meg), Return To Earth (1 Meg) + Flashbier!

**Pack 2 - Fractal Designs** → Mandelvroom, Fracgen, Scenery,  
TurboMandel, SceneGen + many more!

First 200 orders received for a pack get a free gift! Hurry to claim yours!  
Order 2 packs get 2 gifts. Please choose either 2 blank disks, a utility  
disk or a demo disk. Many more fantastic packs available all priced at  
only **£8.50** each! Details on catalogue disks!

**Catalogue Disk only £1.00 including FREE software!**  
(Mandelmountains, Rainbow Writer + 2 BOB demos!)

**Normal PD Prices: 1-4= £2.50 5-9= £2.00 10+= £1.75**  
(Prices per disk)

**CHEQUES/P.O'S payable to: NEW IMAGE SOFTWARE,  
40, APPLEBY GARDENS, DUNSTABLE, BEDS, LU6 3DB.**

**SENLAC SOFTWARE PD**

14 OAKLEA CLOSE OLD ROAR ROAD ST LEONARDS ON SEA  
EAST SUSSEX TN37 7HB TEL: 0424 753070  
SOLE DISTRIBUTOR FOR F.R.P. PRODUCTIONS & SENLACWARE



VISA

**GRAPHICS**

- IFF PIXS I
- IFF PIXS II
- IFF PIXS III
- IFF PIXS IV
- IFF PIXS V
- JOE II SLIDESHOW
- HAM PIXS
- DIGI PIXS I
- DIGI PIXS II
- PHOTOFILE PIXS I
- PHOTOFILE PIXS II
- ROGER DEAN PIXS
- ROD MATTHEWS PIXS
- FANTASY PIXS I
- FANTASY PIXS II
- FANTASY PIXS III
- NASA DIGIPIXS
- SPACE VISIONS
- PARADISE SLIDESHOW

**GLAMOUR DISKS**

- PLAYBOY SLIDES
- SABRINA/SAMFOX SLIDES
- SAMFOX SLIDES
- UTOPIA
- KIM WILDE SLIDESHOW
- NAUGHTY NICITITIES
- TINA SMALL

**GAMES DISKS**

- RETAILIATOR/PACMAN 87
- FLASCHBIER
- AUTOBAHN 3005
- CASINO CRAPS
- POCHESS/TETRISII
- MONOPOLY/CLUEDO
- BATTLEMECH
- MORF
- LARN
- ALL NEW STAR TREK (2 DISKS)
- STAR TREK SPACE 1MEG (3 DISKS)
- STAR TREK 1MEG (2 DISKS)
- EMPIRE
- RISK PD
- CRIBBAGE

**SENLAC DISK PRICES**

5-9 Disks= 1.75 Each  
10-24 Disks= 1.50 Each  
25 or More = 1.25 Each  
Minimum Order 5 Disks

**CANDO CANDO CANDO**

New demonstration Disk for this amazing Hypercard is NOW available from  
SENLAC ONLY 3.00. CANDO RETAILS AT 149.95 OUR PRICE 121.99

**ANIMATION DISKS**

- NOT BEING AGAIN \*
- PROBE SEQUENCE
- WALKER I \*
- WALKER II \*
- ROSES-FLOWERSHOP
- COKEKMAN-SMURF
- KNIGHT ANIMATION \*
- CAR DEMO \*
- ZELUS BUST \*
- DRAGONS LAIR \*
- KILLER DEMO \*
- GHOSTPOOL \*
- COYOTE \* (2 DISKS)
- CHARON \*
- BOINGMACHINE
- ALICE/DOGSWORLD \*
- LUXO TEENAGER \*
- WAVESAILING \* (2 DISKS)
- GYMNAST ANIMATION \*
- CONGAMAN ANIMATION \*
- MINER ANIMATION \*
- JUGGLER ANIMATION \*
- BUSYBEE ANIMATION \*
- ORBITER/SPACESTATION \*
- THE BOINGS \*
- APPLECUS ANIMATION \*
- WALKS ANIMATION \*

**UTILITIES**

- ESA UTILS
- FULLFORCE UTILS
- FUTURE COMPOSER
- DISKALV V4.2
- GHOSTWRITER
- SID (DIRMASTER)
- NIB BACKUP (2 DRIVES)
- CROSS DOS
- VIDEO PROGRAMS (2 DISKS)
- GRAPHICS UTILS (2 DISKS)
- BOOTBLOCK PROGS (2 DISKS)
- RAYTRACING
- LC-10 CUSTOM DRIVER
- PRINTER DRIVER GENERATOR

**FINANCIAL/BUSINESS**

- WORDWRIGHT/AMIGASPELL
- BANK
- ANALYTICAL \*
- RIM DATABASE
- QBASE/VISICALC
- CLERK
- RIM DATABASE (HARD!!)
- SPREAD-SHEET
- INVENTORY

**MISCELLANEOUS**

- OH OBSCENE I
- OH OBSCENE II
- INSANITY II
- SPRITE MACHINE
- VIRUS DISK I
- VIRUS DISK II
- VIRUS DISK III
- DRACO COMPILER (2 DISKS)
- EXPLODINGHEAD/HANDCHOP!

**MUSIC**

- HIFI PLAYER \*
- COMPACT DISK PLAYER
- RIP ERUPTIONS
- ROB HUBBARD MUSIC
- ACCID MUSIC
- JUNGLE COMMAND (2 DISKS)
- GAMES MUSIC CREATOR
- FUTURE COMPOSER
- SOUNDTRACKERS (2 DISKS)
- 8 CHANNEL SOUNDTRACKER
- PERFECTSOUND SAMPLER
- AUDIOMASTER DEMO
- FLASH TEAM MUSIC

**DEMOS-DEMOS-DEMOS**

- NEWTEK I 'DF1: (2 DISKS)
- NEWTEK II 'DF1: (2 DISKS)
- PUGGS IN SPACE
- SPACE ACE DEMO
- VICE WORKBENCH HACKS
- DE-MOB I
- DE-MOB II
- VANGELIS DEMO \*
- UNIVERSAL PICTURES I & II
- RED SECTOR DEMO (2 DISKS)
- SCIENCE 451 DEMO
- BSS JOKES/ANIMS
- HCC TOXTETH DEMO
- DEXTON MEGA DEMO
- FREDDY KRUG SAMPLE
- HIGHCLASS UK DEMO
- REBELS MEGA DEMO

**SENLACWARE DISKS**

These disks are now 5.00 each, a  
contribution is now passed to the Author  
of the program if you wish to participate  
contact SENLAC now for more details...  
FRP ROTATINGWOMEN  
FRP ROADRUNNER  
FRP KARNSATTACK  
FRP PAULA VI  
CREATOR 40 MODELLER  
DEMOS (2 disks)  
Prices include UK Post/Packing  
add 1.00 Overseas Europe  
Airmail charged rest of world

**SENLAC SIX PACKS**

SELECTED PUBLIC DOMAIN DISKS FROM OUR LIBRARY

**ANY PACK ONLY £8.99**

**ART PACK**

1. Photomontage I
2. Photomontage II
3. Photomontage III
4. Fantasy Pixs IV
5. Fantasy Pixs V
6. Fantasy Pixs VI

**UTILS PACK**

1. Ultimate Utilities
2. ESA Utilities
3. Fullforce Utilities I
4. Digital Technology
5. Energy Utilities
6. Ardvard Hackers Toolkit

**DEMO PACK**

1. Red Sector Cebit
2. Red Sector 2 Disk Demo
3. Rebels Mega Demo
4. Puggs In Space
5. It Megademo

**ANIM PACK**

1. Space Ace Demo
2. Agatron Star Trek Demo
3. Probe Sequence
4. Stamp & Balloon
5. Happy Guy & Windowman
6. Zeotrope Animations

**STARTERS**

1. CLI Tutor
2. CLI Utilities
3. Games Music Creator
4. Vallejo Slideshow
5. Flaschbier
6. Compact Disk Player

**HARDWARE BITS**

NEC External Drives 6999  
512K RAM Expansions 5499  
Banx Boxes 995  
Contriver Mouse 1999  
A590 Hard Drive 389.00  
Joysticks from 795  
Call for latest prices

**CATALOGUES**

If you require a catalogue then please send £1.00 now!  
Refunded on first order.



# Demos CORNER

The welcome return, in all-new form, of a very famous demo...

## JUGGETE TBAG 41

The famous juggler is back – and this time he's had a sex change. Yes folks, the demo that sold more Amigas than Commodore did has returned with a vengeance.

OK, it's not quite *Juggler II*, but in the spirit of equal opportunities the Juggler has brought along his missus. This time, however, Mrs Juggler has sacrificed

the ray-traced HAM graphics of the original in favour of the now seemingly trendy Extra Half Brite mode. Although this basically means that the demo lacks the near-photographic qualities of the original, it still retains that special *Juggler* magic that made the original such a smash.

Beg, borrow or steal a copy, because this one's a classic not to be missed at any cost!

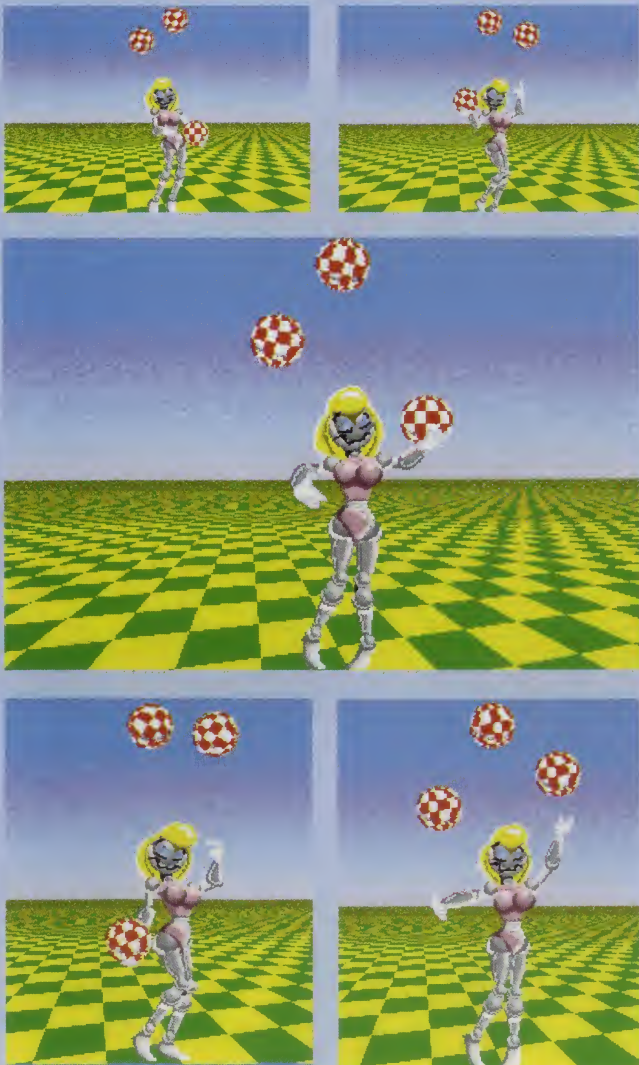

sound samples as instruments. Using the now-familiar *Sound Tracker* editing system, songs are built up from patterns constructed by placing notes into any of the eight available 'tracks'.

Anyone who has used a *Sound Tracker*-like program will know how quickly you'll become acquainted with this method of working. Such a system looks daunting initially, but you'll be surprised how soon you'll be churning out those musical masterpieces.

**RIGHT AND BELOW: *Octalyzer* in all its slightly-bewildering glory.**

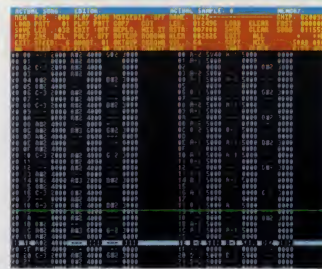

What helps make this latest release far superior to any other *Sound Tracker* utility is the inclusion of both a standard file requester (no more preset editor can't be a bad thing!) and the use of a small font that allows considerably more music data to be displayed on-screen simultaneously.

Just like Microdeal's *Quartet*, *Octalyzer* includes extensive sample editing features. Samples can be cut, pasted, reversed, filtered and generally fiddled around with. Although certainly not the best sample editor in the world, it has

the advantage of allowing direct sampling straight into the *Octalyzer* program – at last you can compose your music and create sampled instruments from within the same program!

Also included is a handy utility to convert standard 4-channel *Sound Tracker* song files to work with this new 8-channel variant. Of course the converted files will still only contain four channels of music data – what did you expect? – but at least you'll now have the opportunity to 'pad out' your music scores with extra music data.



## INTROMAKER Crazy Joe's Disk 580

Ever wanted to create your own demos, complete with scrolly messages, shimmering logos and cliched star fields, but have been held back by one factor – a total lack of programming talent? If so,



ABOVE and ABOVE LEFT: *Intromaker* makes demo-writing easy.



then unleash your demo ideas on an unsuspecting world with *IntroMaker*. Forget about assemblers and other such complicated beasts – *IntroMaker* does all the hard work for you!

### TBAG 41 Amiganuts

TBAG disks have always been worth investigating, and this latest disk certainly isn't going to flout tradition. One particularly nice addition to the TBAG collection is a new icon-driven interface that allows you to run all the programs and read their documentation from a simple menu-based system.

### EnveloPrinter

No prizes for guessing what this program does! *EnveloPrinter* is a program designed to allow use of your Amiga-compatible printer for printing envelope address labels. It allows a large degree of customization, and use of the special styles of your printer.

Features include automatic loading of home-address default, easy-to-use mouse and menu interface, support for Preference printers, custom envelope widths in INCHES (not characters) and a lot more besides.

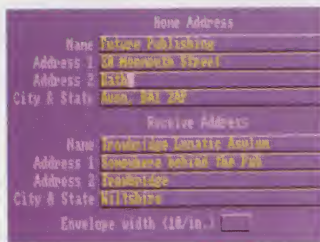

**EnveloPrinter – a bit useful!**

### Garbage Man

It's easy to clutter up your hard disk with unused files. *Garbage Man* is a short utility designed to make disk management easier by reducing such clutter. What it does is search for multiple copies of the same file on a disk, reporting any duplicate files found and what sub-directories the duplicates are in.

### PrFonts

It's all too easy to lose track of what fonts you currently have installed on a particular boot disk. *PrFonts* reads a list of all available fonts and then draws one line of each on a custom hi-res screen and then dumps the screen out to printer. It then clears the screen and repeats the above until all fonts have been printed.

# Demos

CORNER

## DRAGON'S MEGA DEMO Demon Software

Strange how the demos scene seems to be so influenced by fads and 'in' programming techniques. No sooner does one demo crew produce a particular effect, than another follows suit in an attempt to better the original. Dragon's Mega Demo is one such disk, containing several demos that all push existing demo techniques to their limits.



### Lovely Rasters

Wow! If you thought copper colour bars were pretty tame stuff, you've got to check out this little beauty. Colour bars of all descriptions bounce, fly and rotate around the screen in time to a boppy House sound track.

### Artificial Demo

Shaded spherical blitter objects seem to be the in thing to have flying about the screen of your demo these days. Dragon certainly seem to have mastered the art with the Artificial demo. Although certainly not groundbreaking stuff, the combination of fast blitter objects and a thumpingly good heavy synth-rock sound tracks makes for a demo worth seeing.

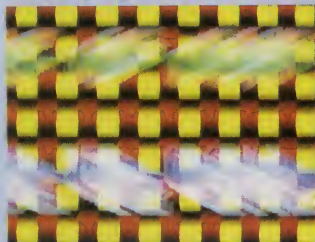

### Unlimited Bobs

Demo writers are a competitive lot. The latest 'challenge' amongst the demo-writing elite seems to be how many blitter objects they can throw around the screen simultaneously.

While everyone else is feeling pleased with themselves because they've managed to display several hundred simultaneously, the Dragon's have pulled the carpet from under their feet with a demo

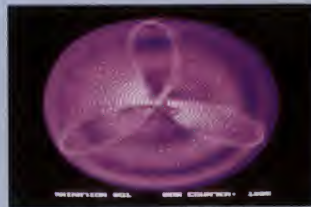

vividly shown within the Multi-Scroll demo. Eight levels of parallax scrolling bounce across the screen. If you ever want to impress your friends with the Amiga's scrolling capabilities, this is the program to load.

### COMA Riverdene PDL

Is it a demo or is it a music video? If you're bored of seeing scrolly text, starfields and bounc-



ing colour bars, then perhaps Coma is for you. Looking more like a music video for one of the latest hip House bands, you just won't believe that you're watching an Amiga screen – Coma really does look like something straight out of Top Of The Pops.

This demo ain't like anything you've ever seen on an Amiga screen. In true 'blip-vert' fashion, images flash on the screen in time to the music while an artist's wooden dummy gets down to the beat. There's only one thing left to say: Che- Che- Check this out!



that draws thousands of BOBs. As the seconds pass, a small BOB counter keeps track of the number of bobs being drawn; first the counter reaches a thousand and you're already impressed, then 2000, then 3000, then 4000, and still the counter continues onward – these guys just don't know where to stop!

### Multi-Scroll

Dragon's talents aren't just restricted to blitter objects – they certainly know how to use the Amiga's scroll hardware, which is



# 17 Bit Software

*That Bit Better Than The Rest!!*

PO Box 97, Wakefield WF1 1XX, England. ☎ 0924 366982  
The UK's Largest Amiga Only PD User Group, over 650 Top Quality  
Public Domain Disks and over 13,500 members in our friendly club

## PD PACKS !! PD PACKS !! PD PACKS !!

### GRAPHICS PACK!!

Over 90 Brilliant screens featuring some of the best in Amiga Art. Features many artistic styles: Fantasy, Hand-drawn, Ray-Traced, Colour-Cycling, Digitised etc...

**7 Disk Pack - £11.00**

### PERVIE PACK!!

Seven disks for the more mature Amiga owner (i.e. **OVER 18'S ONLY!!**) Featuring slideshows of lovely ladies in various states of undress and in animation.

**7 Disk Pack - £11.00**

### MUSIC PACK!!

These disks really show off the Amiga's sonix capabilities. Loads of tunes covering just about the best in Amiga music! Remember, they sound even better blasting through your hi-fi!!

**7 Disk Pack - £11.00**

## FREE LIFE MEMBERSHIP WITH ANY OF THESE PACKS!!

### DEMO PACK!!

Some amazing examples of Amiga coding at it's best! Various demos, intros, megademos and animations. All go to show why the Amiga is the number ONE home computer!

**7 Disk Pack - £11.00**

### ONE MEG PACK!!

A pack of disks for Expanded Amiga's only. Featured here are some of the greatest Amiga demos ever. Some awesome animations that'll leave you speechless!

**7 Disk Pack - £11.00**

### GAMES PACK!!

Sick of paying over the odds for the same old games - try our games pack, seven disks crammed with loads of popular PD games; shoot-em-up, puzzle games, RPG's etc! Brilliant value.

**7 Disk Pack - £11.00**

**MEMBERSHIP** - Are YOU a member of 17 Bit Software? The UK's largest, friendliest Amiga club going? **NO? Why not?** We offer **THE BEST** service, **THE BEST** PD, **THE BEST** prices. Join today with the mind blowing **QUICKSTART PLUS** PACK. 2 newly updated Disks of Various PD Programs/Demos, a Catalogue Disk and the latest issue of our popular Disk Update!

**ALL 4 DISKS PLUS LIFE MEMBERSHIP - JUST £6.50!!!**

## MEGADOS

Megados is an AMIGADOS Manual-on-Disk designed to be an easy to use Self Help reference and tutorial for understanding the CLI and the WORKBENCH, and the background to AMIGADOS.

### MEGADOS

THE AMIGADOS MANUAL ON DISK - FOR LEARNING HOW TO **REALLY** USE YOUR AMIGA!!

**AVAILABLE NOW  
ONLY £6.95!**

Please send me the following goods (tick the packs you require):

GRAPHICS PACK  PERVIE PACK  MUSIC PACK   
DEMO PACK  1 MEG PACK  GAMES PACK   
MEGADOS  QUICKSTART PLUS PACK

Already a 17 Bit member? Please quote your membership number here.....

Name: \_\_\_\_\_

Address: \_\_\_\_\_

\_\_\_\_\_

Total money enclosed: £ \_\_\_\_\_ Method of payment: \_\_\_\_\_

Don't forget to enclose your Cheque/Postal Order or Credit Card Details!! Visa/Access orders welcome over the phone. Telephones manned until 8 pm Monday to Friday.



**MIDI MARVELS!**  
Here's a quick selection of PD programs for all you Amiga MIDI enthusiasts out there.

**CZED  
Fish 323**

What a bargain, missus! *CZEd* is one of those programs that truly demonstrate the quality of Amiga PD software. It was once a commercial release, but programmer Oliver Wagner decided to withdraw the program and re-issue it as a

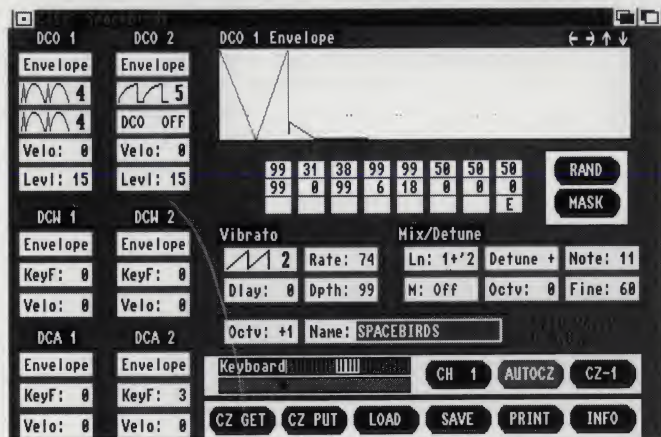

PD freebie – warms the cockles of your heart, doesn't it!

It doesn't take a brain the size of a planet to suss out that *CZEd* is a patch editor for the Casio CZ range of synthesisers. The program is a fully-fledged sound editor that will enable you to edit the sounds within your Casio synthesiser on your Amiga.

Not only that, but the program acts as a split simulator that allows the CZ-101, 1000 and 230S to share voice data. The program can also be used store entire CZ banks out onto Amiga floppy disks, thereby saving you a small fortune in synth RAM cards.

**APOLLO MIDI  
RECORDER  
Softville UGA  
UTILS 11**

The Amiga has never really been particularly well endowed in the music software department. OK, if you want to write jolly little ditties that use the internal sound then there's plenty to choose from, otherwise you're stuck. Things are starting to change, however, with the arrival of *Apollo*, the first ever PD MIDI sequencer for the Amiga.

Although definitely not a *Music-X* killer, *Apollo* is a simple multi-track MIDI recorder program that could serve as an ideal intro-

duction to the world of MIDI sequencing for those too money-conscious to take the plunge and fork out for a 'professional' sequencer. The current version offers 16 tracks of real-time recording with each track being able to hold upto 800 MIDI events.

Although it is perhaps rather too limited to be useful, *Apollo* author Joroen K Sparla hopes to take the project much further by incorporating a fully Intuition-based user interface (let's face it, *Apollo* definitely needs it!) and many extra sequencing tools that will make *Apollo* a real heavyweight package. Let's hope that Joroen decides to place the final product into the PD Libraries!

**K1 EDITOR  
Fish 332**

Kawai K1 synth owners needn't feel left out as the PD libraries have something to offer them as well. The *K1 Editor* is an... er... editor for the K1. You can create and edit voice data for your Kawai from the comfort of the Amiga desktop environment. For added value, the program even includes a couple of auxiliary programs to help with the daunting task of managing sound dumps.

**PD TOP TEN  
GTS Titles**



- 1 ALL NEW STAR TREK
- 2 SACC TRILOGY
- 3 FISH 295
- 4 VIDEO APPLICATIONS
- 5 HOME BUSINESS PACK
- 6 TV GRAPHICS
- 7 EDUCATION PACK
- 8 LEARN & PLAY
- 9 DESIGN FACTORY
- 10 DTP ACCESSORIES

**DEMOS TOP TEN  
17 Bit Disk Numbers**



- 1 NEWTEK DEMO REEL 3 (559/560)
- 2 ALL NEW STAR TREK (595/596)
- 3 PREDATORS MEGADEMO (588/589)
- 4 THE RUN (591)
- 5 TURRICAN DEMO (653)
- 6 INTROS 33 (614)
- 7 FANTASY SLIDESHOW (622/623)
- 8 X-RATED RUBADUBDUB (604)
- 9 KEFRENS MEGADEMO (616/617)
- 10 SCOPEX MENTAL HANGOVER (651)

**SUPPLIERS**

The following companies all contribute to the distribution of Amiga public domain software in this country. For their full addresses check the advertisements in this issue of *Amiga Format*, or give them a ring on the numbers listed here.

**George Thomson Services:** 0770 82234, **Amiga PD Library:** 0742 750623, **Capricorn Computers:** 021 7070381, **Seven Seas PD:** 60 Canary Rd, Dungannon, County Tyrone, N Ireland, **Magnetic Media:** 0827 59566, **EMPD:** 0602 630071, **Blitterchips:** 0535 667469, **Kad-soft UK:** 0249 817174, **Amiganuts:** 0703 785680, **Purple PD:** 0279 757692, **Crazy Joe's:** 0709 829286, **Nova:** 0295 262029, **PD Soft:** 0702 612259, **Softville PD:** 0705 266509, **Sector 16:** 0865 774472, **Senlac Software:** 0424 753070, **Premier PD:** 15 Croxteth Rd, Rainford, **WCA** 0792 772745, **New Image PD:** 40 Appleby Gardens, Dunstable, Bedfordshire, **Beat This Amiga PD:** 5 Fullarton Drive, Troon, Ayrshire, **EPROM Services:** Freepost, Leeds LS27 8YA.

# JTS PD

**NOW ONLY 1.50 PER DISK!**

*The best for less, and a great service!*

- Ousiders Acid Demo - A great demo disk containing a really good music/video (1)
- Digital Concert 3 - 12 minutes of sequenced samples forming an excellent mix! (1)
- JTS Music Ripping Disk - Lots of utilities used to rip music from demos etc. (1)
- Kefren's Megademo 8 - The best megademo so far, better than Red Sector even (2)
- Scoopex Mental Hangover Demo - Great filled vectors and haunting music, great (1)
- Showering Girls - Excellent b/w animation of two girls, very good quality! (1 meg) (1)
- Electric Blue "Bra-busters" - b/w animations, cert XXX. Good quality... (1)
- All New Star Trek Game - Great playability on the game by AGAtron. Good fun! (2)
- It Came From The Desert Demo - Very good animations and sound of the game. (1)
- Home Business Pack - 3 disks containing a spreadsheet, wordprocessor and a great database with full instructions on it (3)
- Alpha Flight Demo Creator - Make your own demos with ease, also includes a very good font editor (1)
- Better P.D. Fonts #1- A disk full of the best fonts for use with all paint programs (1)
- JTS Soundtracker Compilation - A 5 disk set, containing 1 utility disk (with various versions of this great music maker) with 4 instrument disks (5)

For a free update of our latest catalogue, just send a blank disk or an S.A.E.!

**COMMERCIAL OFFER: PHOTON PAINT 2 22.00** (rrp 89.95)

Send orders with a cheque or postal order to JTS P.D.

2 Ashfield, Wetherby LS22 4TF  
Telephone: 0937 63834

LIMITED OFFER • LIMITED OFFER • LIMITED OFFER

# LOWEST PRICES EVER!

LIMITED OFFER • LIMITED OFFER • LIMITED OFFER

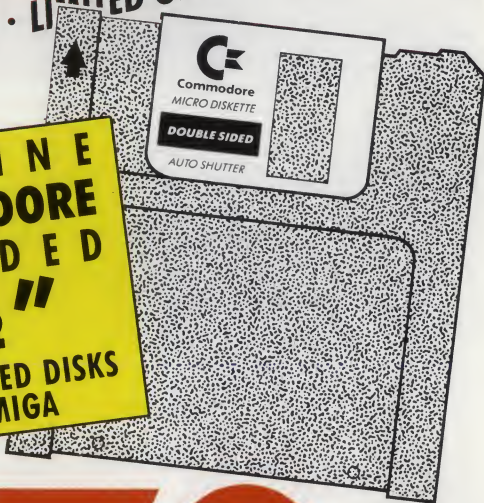

**GENUINE COMMODORE BRANDED 3 1/2" DOUBLE SIDED DISKS FOR AMIGA**

**FROM AS LITTLE AS**

**70p** EACH INC. VAT

COMMODORE 3 1/2"	
10	<b>£9.99</b>
50	<b>£39.99</b>
100	<b>£69.99</b>

GENUINE COMMODORE 3 1/2 INCH DOUBLE SIDED HIGH QUALITY BRANDED DISKS AT CRAZY PRICES. CHEAPER THAN MOST UNBRANDED. ORDER TODAY - LIMITED OFFER.

**24HR ORDER HOTLINE - 0509 610444**

**Compumart FREE DELIVERY**

COMPUMART, DEPT. AFM, JUBILEE DRIVE, LOUGHBOROUGH, LEICESTERSHIRE LE11 0XS.



All prices include V.A.T.



# KAD-SOFT UK

**BRITAIN'S FASTEST-GROWING AMIGA PD LIBRARY**

- KA1 - The Business Collection. Spreadsheet, Database & Wordprocessor. 2 disks.
- KA2 - The Wordprocessor for the Amiga
- KA3 - C-Compiler Assembler & Linker
- KA4 - The brilliant RIMS database programme
- KA5 - Disk Doctor Collection
- KA6 - CLI Help. Worried by CLI? This one will make everything clear.
- KA7 - A Collection of brilliant arcade games.
- KA8 - Predators Mega Demo. Brilliant twin disk demo.
- KA9 - Break out construction set
- KA10 - Nightmare on Elm Street Demo
- KA11 - North Star and Silent Demo
- KA12 - Star Trek Brilliant 3 disk game
- KA13 - Deluxe Music Construction Kit A collection of instruments for the original programme.
- KA14 - Magnetic Fields Demo. The Ultimate Bobs & Sprites Demo
- KA15 - Robocop Demo. Brilliant
- KA16 - Star Trek The Next Generation. 1 Meg shareware
- KA17 - Space Ace demo
- KA18 - The North Star Mega Demo
- KA19 - Cool Cougar Demo. Cartoon quality
- KA20 - Virus Killer
- KA21 - The Anti-ST Demo Disk
- KA22 - The Miami Vice demo. Digitized sounds
- KA23 - Kylie Minogue Demo disk 1
- KA24 - Kylie Minogue Demo disk 2. Needs KA23 to run.
- KA25 - Larn version 12. Brilliant Dungeons and Dragons game.
- KA26 - Shanghai. Playable demo of great game.
- KA27 - Utilities collection 1. Quick copy, P copy, Dir Master, Funckery, Blitz, Virus X
- KA28 - Games Collection 1, Cribbage, Tiles, Bullrun, Tic Tac Toe.
- KA29 - Games Collection 2, Amoeba, Yelp, Rock Slide, Egyptian Run.
- KA30 - Bankn, Home Help, Home Finance Packages.
- KA31 - Elvira; brilliant demo.
- KA32 - RAF mega demo. Brilliant 2 disk demo.
- KA33 - QL emulator.
- KA34 - North Star and Fairlight mega demo 3. Brilliant 2-disk demo.
- KA35 - Death Star mega demo. Yet another twin-disk demo.
- KA36 - Fractal Flight. Brilliant fractal demo.
- KA37 - Viz Slide Show.
- KA38 - Fish Games Collection. 3 disks.
- KA39 - Holy Grail Adventure. Brilliant text adventure 1Meg.
- KA40 - Star Trek The New Version. Brilliant 2 disks.
- KA41 - Tiffany demo

All discs - £2.50 inc P&P Ring for FREE Catalogue

**We stock the complete range of Fish, Amicus, Slip Disk, T-Bag and Panorama Disk Collections.**

DISKS	ACCESSORIES
3.5" 135 tpi DD/DS Disks Unbranded (KAO, Sony) 100% error free. Certified very high quality will format to 880k easily.	Disk Boxes
10 25 50 100 200	80 cap - £5.50 120 cap - £7.50
£6.80 £13.80 £26.00 £50.00 91.00	Mouse Mats - £3.50
All price include P&P, Labels	Mouse Holders - £3.50
No quibble Money Back Guarantee	Amiga Dust Covers - £4.50
	A complete range of commercial software available, both business and home, at very competitive prices.

Amiga A500 External Disk Drives .....£65.00 A500 1/2 meg Upgrade .....£53.50

Send Cheques & P/O's payable to:

**KAD-SOFT, 2 EBOR PADDOCK, CALNE, WILTS, SN11 0JY**  
**TEL: 0249 817174**



# BLITTERCHIPS

P.O. Box 64, Keighley. BD21 4NB  
TEL/FAX: (0535) 667469 10AM TO 7PM MONDAY TO FRIDAY

- |    |                                  |     |                                       |
|----|----------------------------------|-----|---------------------------------------|
| 1  | Tiffany Demo.                    | 78  | Holy Grail Adventure (1 Meg Required) |
| 2  | Kylie Demo (2 disks)             | 79  | Educating Cougar Animated Demo        |
| 3  | Debbie Gibson Demo.              | 80  | Space Ace Game Demo                   |
| 4  | Walker Demo (1 Meg)              | 81  | Holstein Pils T.V. Ad Demo            |
| 5  | Waker Demo 2 (1 Meg)             | 82  | Blowfly Music (Could Be Offensive)    |
| 6  | Kaktus And Mahoney               | 83  | Miller Lite T.V. Ad Demo              |
| 7  | North Star Demo 2                | 89  | Darkstar Music Disk 4                 |
| 8  | Byterapers Muzzax 6              | 90  | Space Fighter (Ray Traced 1 Meg)      |
| 11 | Utopia 4 (Over 18 years)         | 94  | Deathstar Mega Demo (2 disks)         |
| 12 | Bootbench V2.0 Demo Creator      | 95  | Dexion Mega Demo (Great)              |
| 13 | Larn The Adventure Game          | 101 | Gymnast Ray Traced Demo (1 Meg)       |
| 14 | SAE Scoopex Demo 36              | 102 | Horror Show (Exploding Head Ect.)     |
| 15 | SAE Scoopex Demo 40              | 103 | Darkstar/Silents Acid Music           |
| 16 | Luxo Teenager (Ray Traced 1 Meg) | 104 | Yellow Music Disk                     |
| 17 | Clapping World Music Demo        | 106 | Mighty Druids March 90 Demo           |
| 18 | SAE Scoopex Demo 35              | 111 | Exodus Scrolly Pic. Show (1 Meg)      |
| 19 | Arcadia Mega Demo 1              | 112 | Space Bubbles (Fantasy Nude Pics)     |
| 20 | Forgotten Realms Slideshow       | 113 | Animate Window Pack 1                 |
| 21 | Black Monks Picture Show         | 114 | T.H.R. Demo Disk 10                   |
| 22 | Kelfrens Demo                    | 115 | Rebellion/4 Mat Music Disk            |
| 23 | Outsider Acid Music Demo         | 121 | Scoopex Mental Hangover (Superb)      |
| 24 | Elvira Game Demo                 | 122 | Mayhem Demo Disk                      |
| 25 | Fresh Cola Music (2 disks)       | 123 | Anarchy Demo Disk                     |
| 26 | Juggler Ray Traced Demo          | 124 | Sun Slide Show 2                      |
| 27 | Sunrise Volume 8 Demo            | 125 | T.H.R. Demo Disk 11                   |
| 28 | Pendle Europa Disk 53            | 131 | Magnetic Fields Demo 36               |
| 29 | SAE Scoopex Demo 25              | 132 | Dragons Mega Demo (Good)              |
| 30 | Sam Fox (Stretch That Monitor)   | 133 | Cult Mega Demo (Good)                 |
| 31 | Probe Sequence                   | 134 | A.E.C. Demo 2 (Good)                  |
| 32 | PCS House Music                  | 135 | Power Lords Power Music 2             |
| 33 | AMOS Game Creator Demo           | 141 | Beatmasters Cub Mix Music             |
| 34 | Forgotten Realms Slideshow 2     | 142 | Track Hacks By The Byte Factory       |
| 36 | Mechanical Minds Music           | 143 | Internal Vendetta (ITV) Music         |
| 43 | Pugs In Space Animated Demo      | 144 | Music Maestro 6 (9 Tunes)             |
| 44 | Trilogy Mega Demo (2 disks)      | 149 | Madness Demo Disk                     |
| 45 | Kelfrens Mega Demo (2 disks)     | 150 | Sonic House 2 Music                   |
| 46 | Pendle Europa Disk 50            | 156 | Bordellow Beauties 1 (18 Yrs)         |
| 51 | Enemies Music Disk 3             | 157 | Bordellow Beauties 2 (18 Yrs)         |
| 52 | Vision Mega Demo 4               | 158 | Bordellow Beauties 3 (18 Yrs)         |
| 53 | NASA Pics. Digitised Slideshow   | 159 | Bordellow Beauties 4 (18 Yrs)         |
| 54 | Darkstar Utilities Disk 4        | 160 | Bordellow Beauties 5 (18 Yrs)         |
| 65 | Cryptoburners Music Disk         | 166 | Bordellow Beauties 6 (18 Yrs)         |
| 66 | Predators Mega Demo (2 disks)    | 167 | Bordellow Beauties 7 (18 Yrs)         |
| 68 | Vangelis Demo (1 Meg Required)   | 168 | Bordellow Beauties 8 (18 Yrs)         |
| 69 | SCA's Miami Vice Theme (4 disks) | 169 | Bordellow Beauties 9 (18 Yrs)         |
| 70 | Megatron Man Slideshow (18 yrs)  | 170 | Bordellow Beauties 10 (18 Yrs)        |

PLEASE NOTE, THIS IS YOUR LAST CHANCE TO BUY DISKS AT ONLY £1 EACH. PLUS 50p POST AND PACKING PER ORDER. THIS OFFER ENDS ON THE 6th AUGUST. CREDIT CARD ORDERS. PLEASE PHONE BEFORE 12 NOON FOR SAME DAY DESPATCH. OPEN 10am To 7pm MONDAY TO FRIDAY, 9am To 4pm SATURDAY. YOU MAY PAY BY ACCESS, VISA, POSTAL ORDERS OR CHEQUES.

# E.M.P.D.L

Amiga Public Domain Library. Open 7 Days 9am - 9pm

## E.M.P.D.L. STARTER PACK.

A 3 disk collection of the most useful utilities including Wordprocessors, Spelling Checkers, Database, Spreadsheet etc. **STAR TREK.** The 2 disk game reviewed by Amiga Format. **FISH GAMES.** A 3 disk collection of the latest games from Fred Fish. **T.V. GRAPHICS.**

2 disk set of backgrounds and fonts for video enthusiasts. **VIDEO APPLICATIONS.**

2 disk set of video utilities to accompany T.V. Graphics. **GRAPHICS MANAGEMENT.**

2 disks of the best graphics utilities for the Amiga **CZ.Sozobon "C" compiler.** Fully functional. Complete with linker, assembler etc. **INTRO PACK.** A 3 disk pack of the best disk intros around. **ANIMATION PACK.** 3 disks of the best animations on the Amiga. **DEMO PACK.**

3 disk pack of some of the best music/graphics demos. **CLIP ART.** 3 disk pack of the most useful clip art. **SLIDESHOW PACK.** 3 disk slideshow of digitised pictures. **BLACK BOX.** "Ride on time" demo. **POPEYE MEETS THE BEACHBOYS.** Brilliant demo. **KYLIE MINOGUE.** 2 disks of music and pictures for the "Kylie" fans. **ELVIRA .** 1 Meg. demo of the game that might have been!!! **FLASH GORDON.** 2 disk digitised music demo of "Queen."

NEW!!! "VACCINE" Hardware Virus Protection System. All orders received before 31st. July will receive a free Anti-virus booster disk.

All our disks are virus free and despatched by first class post on day of receipt at the inclusive price of £2.50 per disk. Over 900 disks in our latest edition catalogue. Send for yours now.

We are also authorised distributors for "Newsflash".

The very best disk magazine for the Amiga.

Full range of accessories at the best possible prices

Cheques & P.O.'s payable to:

E.M.P.D.L.

54 WATNALL ROAD,  
HUCKNALL, NOTTS, NG15 7LE.  
0602 630071



EXPERIENCED

## BEAT THIS AMIGA PD

Free Club Membership

Write now for details of July/August FREE PD DISK offer

ANY OF OUR PD DISKS FOR ONLY **£1.75**

☆ 1 - 4 Disks £1.75 ☆ 5 - 9 Disks £1.70 ☆

☆ 10 - 24 Disks £1.60 ☆ 25+ Disks £1.50 ☆

We have several **Special Offer Packs** at low prices

e.g. ☆ Home Business Pack (8 disks) only **£12.99**

includes: Home & Business Accounts, Database, Disk Label Printer, Wordprocessor + dictionary, Spreadsheet scheduler and even more...! (Best selling pack)

☆ Sonix music pack (5 disks) **£7.99**

☆ Star Trek demos and game pack - 1 meg (6 disks) **£9.50**

### WE ALSO HAVE 3.5" BLANK DISCS IN STOCK

10 Blank disks + 1 FREE PD disk .....£8.00

25 Blank disks + 3 FREE PD disks .....£19.00

50 Blank disks + 5 FREE PD disks .....£35.00

Choose your FREE PD disks from any in our list

Prices include **1st Class P&P.** Orders nearly always despatched the **Same Day.**

Send a S.A.E. for a copy of our PD software lists. Make Cheques Payable to:

**BEAT THIS AMIGA P.D.**

5 Fullarton Drive

Troon

Ayrshire KA10 6LE

Scotland

£ VALUE £

FAST & EFFICIENT

## AMIGA PUBLIC DOMAIN

LOOK!!

☆ HUNDREDS OF TITLES ☆ STARTER PACKS ☆

☆ FAST, RELIABLE SERVICE ☆

**NOW ONLY**

**£1.80 each or £16.50/10**



Pack A	Delirious 1,2,3 & 4 (XXX)	(4 discs)	£6.50
Pack F	Titanics, Crusaders, Trash & TTB Music	(3 discs)	£5.00
Pack L	Every inch a lady Sabrina, Sam Fox (15)	(3 discs)	£5.00
Pack M	Tiffany, Madonna, Debbie Gibson, Kylie	(4 discs)	£6.50
Pack O	Mayfair, BFPO 2&3, Calendar Girls (XXX)	(4 discs)	£6.50
Pack P	Body Talk A&B*, Showering Girls* (XXX)	(3 discs)	£5.00
☆☆☆ <b>SPECIAL OFFER</b> ☆☆☆			
Pack A + Pack L + Pack O (XXX)		(11 discs)	£16.00

\* 1 MEG OR MORE XXX ADULTS ONLY

CALLERS WELCOME MONDAY TO SATURDAY 09.30 - 17.00, WEDNESDAY 09.30 - 13.00

SEND A LARGE S.A.E. FOR LATEST CATALOGUE. PLEASE MAKE CHEQUES/POSTAL ORDERS PAYABLE TO:

**MAGNETIC MEDIA**  
VICTORIA ARCADE, ALDERGATE  
TAMWORTH, STAFFS B79 7DL  
TEL: 0827 59566

**PRICES INCLUDES VAT**  
**1st CLASS POST IN UK**  
(Airmail Postage: Europe/Scandinavia £3.50/10  
Other countries £6.50/10)

### PD SPECIALISTS

Eprom Services  
88 Leylands Lane  
Bradford  
W. Yorks. BD9 5QS

## EPrOm SeRvIcEs

At Eprom Services, we offer a lot more than just PD software. As well as having one of the finest collections around, which we sell at rock bottom prices.

1-6 disks = **£1.60**  
7-19 disks = **£1.35**  
20-30 disks = **£1.05**

We also sell a large amount of accessories and commercial software at very small prices.

**A SPECIAL INTRODUCTORY OFFER IS ANY 3 OF THE 8 DISKS BELOW FOR JUST £3.50**

ESM001 - D-MOB Music One  
ESM002 - Jungle Mania  
ESD003 - Space Ace Demo  
ESD004 - Robocop Fx.

ESM005 - Batdance Remix  
ESG006 - Flaschier  
ESU007 - Ghost Writer  
ESU008 - Virus X v.4

Send Cheque/P.O. For a full listing of PD software and accessories write to:

**EPROM SERVICES**  
**FREESOP**  
**LEEDS, LS27 8YA**

**DON'T SUPPLY A STAMP, WE DO THAT!!**



# ON YOUR DISK

## CADAVER

The Bitmap Brothers are back with a vengeance. *Cadaver* is graphically brilliant, sonically superb and the game-play is second to none. Find out for yourself with our exclusive demo of Imageworks' latest masterpiece.

## FENSTER

Forget *ScreenX*, for *Fenster* is here. Never before in the history of screen handling utilities have so many tools been available within such a small utility.

## ZAP

Forget *FileZap*, for *Zap* is here. Edit binary files to your heart's content with *Zap*, the first truly multitasking binary file editor that has more well-designed and fun-to-use features than Britt Ekland.

## POPUPMENU

Forget, erm, something or other, for *PopUpMenu* is here. With *PopUpMenu*, never again will you have to move the mouse pointer all the way across the screen to access pull-down menus.

## MENACE SOURCE

In the last enthralling installment of the *Menace* saga, the end-of-level guardian rears its ugly head. Pick the source to pieces, then play the game.

## LHARCA

One for modem users, this. Archiving utilities have always been rather unfriendly fellows. That was, of course, until the arrival of *LHARCA*, the world's first Intuition-based archiving utility.

## COPPER TUTORIAL

No, we're not trying to turn you into one of the boys in blue. We are of course talking copper of the silicon variety. Study and learn from Paul Andreas Overa's subtle C source code.

UP TO

# £800

UP FOR GRABS!

Think you've got what it takes to write for the *Amiga Format* Coverdisk? Get your programming tools out and prove what you can do, and earn yourself some cash in the process. We're after Workbench hacks, demos, utilities, games, game cheats... You could earn up to £800! Turn to Page 92 for details.

BACK UP YOUR COVERDISK IMMEDIATELY!!!

DON'T KNOW HOW? SEE P 92 FAST! ENSURE YOU WRITE-PROTECT YOUR DISK BEFORE USE!

# disk EXTRA

**A marvellous playable demo of the Bitmap Brothers' latest, *Cadaver*, heads up this month's high-quality assortment of software at a price that's right for your pocket. There's so much more than TV times on this month's *Amiga Format* Coverdisk!**



He may look like *Noggin the Nog*, but our little fellow is one hard case of a hero and is quite capable of handling himself.

## CADAVER

PROGRAM: IMAGEWORKS

FILES: CADAVER,

CADAVER.DOC

Wulf castle stands alone in the dense swamps that surround it. Once the power-base of the Wulf dynasty, it now lies deserted except for one person: Dianos the Necromancer. Many legends pervade the old ruin: tales of fallen knights, an exiled brother and a treacherous chancellor.

Hired as a bounty hunter by the captains of the murdered Lord Carolus, you are asked to enter the castle and destroy his assassin, the insane Chancellor Dianos. Many rooms lie between you and the upper chambers where Dianos has taken up residence and,



Arms and the man - a spear!



Checking in chests could be a good way of tracing treasure...

considering the recent struggles that have taken place, there will be lethal traps waiting around every corner. Monsters of many kinds have taken up residence with the evil Necromancer and others have been summoned from their ethereal planes to serve his every wish without question.

Looming in the darkness, the evil of Wulf Castle awaits you. Go forward, brave knight, and rid the land of Dianos' tyranny. Oh, and don't forget to switch off all the lights and put the cat out before you leave.

## The Demo

Anyone remember those classic 3D isometric games that were so popular on the 8-bit machines a few years back? *Cadaver* continues the tradition while still managing to add a healthy smidgeon of that magic that only the Bitmap Brothers and the Amiga can deliver. *Cadaver* is played using a joystick and occasional key presses, so have your joystick plugged in and you'll be ready to rock and roll.

The small level on this playable demo of *Cadaver* was specially created for *Amiga Format*. It is not a part of the finished game as the Bitmap Brothers felt that revealing any of the challenges before the release of the product would mar future players enjoyment. The action is



black line through the centre of the screen after the game has loaded, reload the demo again by turning your machine off then on again (this clears the memory completely). Do not touch the mouse while the game is loading.

set within the gatehouse as a prelude to the castle itself.

Players will find a selection of puzzles, spells, potions and one monster type in order to practice those skills necessary for playing the full game. Not all items that are found littering the building will be of use, but most are worth investigating. It is not necessary to solve all the puzzles to complete the game, but many will provide bonuses of gold or experience.

**Getting Going**

Can't wait to get started? Then turn on your Amiga with the Coverdisk in the internal drive and you're half-way there already. When our scrolly message screen pops up, just click the left mouse-button and the game will automatically load. If you get a vertical

**FENSTER PROGRAM: ROGER FISHLIN FILES: FENSTER, FENSTER.DOC, ARP.LIBRARY**

Here it is, the definitive Intuition screen and window management program. Forget *Snapshot*, forget *ScreenX*, forget the rest, *Fenster* has no competition. Within this single program, you'll find every tool that you could ever wish for to help you keep all those windows and screens on the leash. With *Fenster* you can:

- Close any window or screen without the program that generated it ever having to know...
- Save a screen, or even a window, as an IFF compatible file that can be loaded into any Amiga

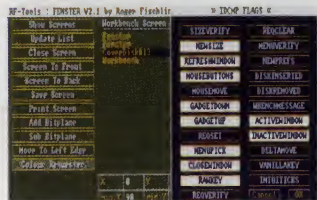

has to offer by opening a custom screen containing loads of useful gadgets. For more info on how to actually use the power now at your disposal, check out the documentation file, *FENSTER.DOC*.

**POPUP MENU PROGRAM:**

**FILES: POPUPMENU, POPUPMENU.DOC**

Pull-down menus are old hat. Improve your Workbench with *PopUpMenu*, a handy little utility that rids Workbench (and any programs that are run after installing *PopUpMenu*) of the menu strip and those pull-down menus.

What's wrong with pull-down menus?, I hear you ask. Simply, every time you wish to access a menu you have to move the mouse pointer out of the window that you are working in and move it up to the top left-hand corner of the screen. With *PopUpMenu*, press the right mouse button and those menus appear instantly anywhere on the screen. Pretty clever stuff, I'm sure you'll agree!

**Getting Started**

Double-click on the *PopUpMenu* icon and that's it - from now on, every program that uses Intuition menus will work perfectly well with *PopUpMenus* (just check out the screenshot on the bottom of this page for proof positive). Instructions (you need instructions?) are in the usual place.

**ZAP**

**PROGRAM:**

**FILES: ZAP, ZAP.DOC**

*Zap*, as the name doesn't suggest at all, is a binary file editing program. You can examine and modify the file in both hexadecimal form and in ASCII.

Unlike other programs we could mention, *Zap* keeps the file in memory, so moving around the file and searching for chunks is very fast. That said, keep your eye on the memory meter, because *Zap* can gobble up the memory when editing large binary files.

What sets *Zap* apart from that other great binary file editor, *NewZap*, are its multi-tasking capabilities and lightning fast operational speed. Instead of hogging the entire screen display like *NewZap* always used to do, the *Zap* window can be re-sized and pushed around the screen without a single complaint.

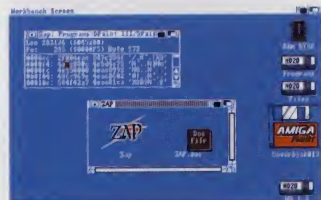

**Getting Started**

*Zap* can be started either from CLI or Workbench. When starting from CLI, the file name can be given as a command line parameter. If the name contains spaces it can be enclosed in double quotes.

When starting *Zap* from Workbench, a file can be selected by first clicking the *Zap* icon and then holding down the shift-key and double-clicking the icon of the file you want to edit.

If you don't specify a file name when starting up the program, you can always use the Load menu option to pull a file into *Zap*.

paint package to be touched up...  
 • Dump any screen to printer without having to mess around with the crummy Workbench screendump utility...  
 • Change the attributes of any screen or window without having to mess around with binary file editors. You can change a windows size, change its IDCMP flags, refresh any gadgets...

**Getting Started**

Before you can use *Fenster*, you will first have to install *arp.library* onto the boot disk of your Workbench disk.

This can be achieved by double-clicking on the *Install\_Arp* program that can be found within the *LHARcA* drawer (not the *Fenster* drawer). This may involve some disk swapping, but once it's complete you're ready to go.

Double-click on the *Fenster* icon and this power-packed, super dooper little utility will spring to life. OK, a little window will open. This is *Fenster* in sleep mode. If you now activate the *Fenster* window by clicking on it and then press the right mouse button, *Fenster* will show you everything it

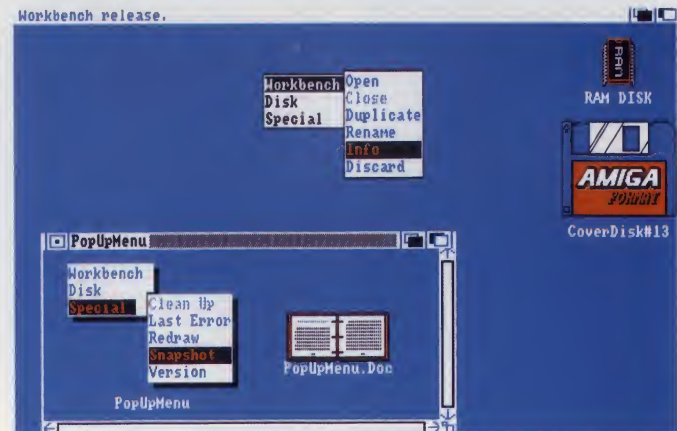
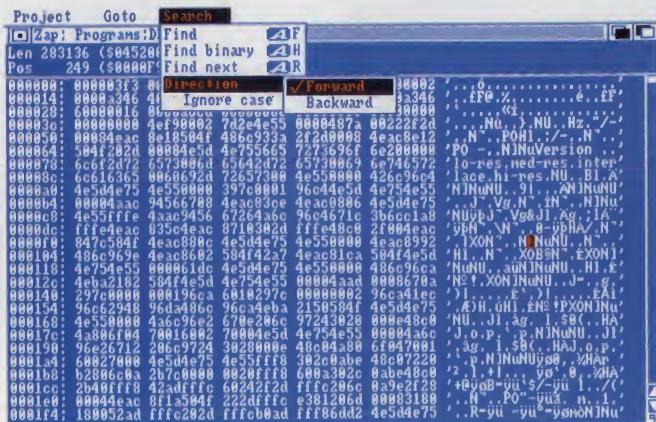



# RIVERDENE PDL for the Amiga

63 Winttingham Way, Purley on Thames,  
Reading, Berkshire RG8 8BH.

Telephone: (0734) 428492 Fax: (0734) 451239

DEMO PACK 1. REBELS COMPILATION, RSI CEBIT 90 & DEXION II  
DEMO PACK 2. AMOS, F-29 & E-MOTION

ART PACK 1. NASA, STAR WARS & ROGER DEAN SLIDESHOW

ART PACK 2 (1 MEG RAM), NEWTEK REEL 3 (2 DISKS) & THE RUN

HOME UTILITIES PACK. WORD WRIGHT, QUICKBASE & BANK N

GAMES PACK. QUIZ MASTER, TRACK RECORD & BREAKOUT

MUSIC PACK. SOUNDTRACKER, SOUNDTRACKER SAMPLES & PERFECT SOUND

**All Packs only £5.50 each**

inclusive of 1st Class Postage & Packing

Please state Amiga when ordering

## FREE PD CATALOGUE ON DISK

(please state Atari ST or Amiga)

when you send a blank disk and SAE to RIVERDENE PDL  
ACCESS & VISA welcome



# HAMMERSOFT

VISA

### MAIL ORDER SOFTWARE SPECIALIST

#### HARDWARE U.K. ONLY.

(Free delivery)  
(Courier £5.00)

AMIGA PACK 1:  
Amiga A500 Batpack Inc. TV  
modulator, Batman, Interceptor, New  
Zealand Story, Deluxe Paint II, 23 PD  
Games .....375.00  
AMIGA PACK 2:  
Amiga Flight Of Fantasy +23 PD.....375.00  
AMIGA PACK 3:  
As in 1or 2 with 10 Games.....399.00

#### ATARI LYNX

Portable Game Console .....159.90  
Amiga A500 & Stereo Monitor .....619.00  
Philips 8833 Stereo Monitor .....249.00  
Commodore 1084S Monitor .....249.00  
A590 Hard Drive .....360.00  
1/2 Meg Expansion/Clock .....69.00  
Cumana 3.5" Drive, Port+Switch85.00  
Olivetti colour printer .....210.00  
Star LC10 Colour Printer .....225.00

#### LEISURE

Altered Beast .....16.50  
AMOS Game Creator .....34.90  
BATTLE CHESS .....16.99  
Castle Master .....16.99  
CHASE HQ .....16.99  
CYCLES (THE) .....16.99  
Damos .....16.90  
Emlyn Hughes Soccer .....16.90  
Escape From Robot Monsters .....14.50  
ESCAPE FROM SINGE'S CASTLE .....34.90  
Fire & Brimstone .....16.90  
Gauntlet II .....8.99  
International 3D Tennis .....16.99  
Interphase .....15.90  
Italy 1990 u.s. gold .....16.99  
It Came From The Desert (1 meg) .....19.99  
Warhoe .....16.99  
Kick Off II + World Cup '90 .....15.99  
Knights Of The Crystalion .....19.99  
Lost Patrol .....17.50  
Magnum 4 (4 pack) .....19.99  
MIDWINTER .....19.90  
Moonwalker .....15.50  
Ninja Spirit .....17.50  
Player Manager .....13.90  
Populous .....16.99  
Promised Lands .....8.99  
Rainbow Islands .....16.99  
Scrabble Deluxe .....14.90  
Shadow of the Beast + T Shirt .....20.90  
Shadow Warrior .....16.99  
Side Arms .....9.99  
Sim City .....19.90  
Sim-Terrain Editor .....11.99

Space Ace .....34.90  
Space Harrier II .....12.90  
Speedball .....16.50  
Stryx .....12.90  
THREE STOOGES .....17.90  
Tennis Cup .....17.50  
Time Soldier .....16.90  
Tower Of Babel .....16.90  
Triad II .....16.99  
Triad III .....20.99  
Untouchables .....16.50  
Warhead .....16.99  
XENON II MEGABLAST .....16.90

#### ADVENTURE RPG & SIMULATION

688 Attack Sub .....17.50  
Battle Master .....20.99  
BLOODWYCH .....14.90  
CONQUEROR .....16.99  
Dragons Breath .....20.99  
Drakken .....19.90  
DUNGEON MASTER (1 MEG) .....17.50  
Faery Tale Adventure .....13.90  
F-16 COMBAT PILOT .....16.90  
F-29 RETALIATOR .....16.90  
Flight Sim II .....26.90  
Southern Europe Scenery .....13.90  
Hawaiian Odyssey .....13.90  
Heroes Quest (1 Meg) .....24.90  
Leisure Suit Larry II .....23.90  
Leisure Suit Larry III .....26.90  
THEIR FINEST HOUR, 1 MEG  
Option .....20.99  
ULTIMA V .....20.99  
Ultimate Golf .....16.99  
XENOMORPHI .....16.50

#### MUSIC APPLICATIONS

Aegis Sonix 2.0 .....39.90  
Mastersound Digitizer .....35.90  
Deluxe Music .....50.00  
FutureSound Digitizer .....79.90  
MUSIC X U.K version .....89.00  
Midi Master Interface 5 ports .....32.95  
Midi Lead .....2.99

#### BUSINESS & EDUCATION

Advantage .....79.90  
Arena Int. Accounts (1MB) .....119.50  
Discovr: Maths, Numbers,  
Chemistry or Alphabet (each) .....13.99  
Fun School 2  
Under 6's, 6-8's or over 8's .....13.90  
Robot Readers: 3 Bears .....24.00  
Spellbook 4-6 or 7+ .....19.90  
Hisoft Basic .....56.00  
Home Accounts .....20.99  
Home Office Kit .....99.50  
Kindwords 2 .....39.90  
Mavis Beacon Typing Tutor .....20.99

#### Micro GCSE:

Maths, French or English .....19.90  
Micro Text Word Processor .....19.90  
MicroBase Database .....19.90  
PAL (PAL) (1MB) 98.90  
Prodala .....56.00  
PROTEXT V4.2 (rec.1 MB) .....65.90  
Pagesetter II (PAL) (1MB) 74.90  
Professional Page 1.3 (1Meg) 173.90  
PUBLISHERS CHOICE .....68.50  
Starter Kit .....52.00  
System 3 .....44.50  
Transcript .....32.90  
Word Perfect 4.1 Current Ver 159.90  
WORKS PLATINUM .....99.50  
Workbench 1.3 Software Manual .....14.90

#### QUALITY JOYSTICKS & ACCESSORIES

Comp Pro 5000 .....13.90  
Comp Pro Extra .....(clear auto) 14.90  
Super Professional (autofire) .....13.90  
Micro Blaster .....(autofire) 13.90  
A500 Control Centre .....44.00  
A500 Dust Cover .....4.95  
Mouse Mat .....5.95  
10 x 3.5" DSDS disks + labels .....7.95  
**T.D.K. AUDIO & VIDEO TAPES**  
AD90 (x5) .6.75 E240-HS (x2) .....8.99  
AR90 (x5) .7.45 E180-Hi Grade 4.99  
SA90 (x5) .8.99 E240-Hi Grade 5.99  
SAX90 (x3) 6.49 E180-HiFi .....5.99  
MA90(x3) .8.55 E240-HiFi .....6.99  
MP90-8mm .....7.99

\* = Available on Release

Prices all include VAT & 1st Class  
Postage in U.K. (Europe please add  
£2.00 per item) Return of Post Service  
on Stock Items

Please Send Cheques/Postal Orders to:  
**HAMMERSOFT, (DEPT F)**  
47 MILL ROAD,  
HETHERSETT, NORWICH,  
NORFOLK NR9 3DS  
Access, Visa, Eurocard & Mastercard Accepted. Cheques Subject to clearance

Titles Available on  
Request  
ORDERS ENQUIRIES:  
TEL (0693) 812416

# CRAZY JOE'S PD

★ OVER 600 PD DISKS IN STOCK ★ NO MEMBERSHIP FEE ★

★ GAMES, DEMOS, UTILITIES, MUSIC, SLIDESHOWS ★

★ DISKS £2 EACH/£15.00 FOR 10 ★ BLANK DISKS £7 FOR 10 ★

★ COMMERCIAL SOFTWARE AT DISCOUNT PRICES ★

### A FEW FROM OUR CATALOGUE

57	Who's That Girl (XXX)	481	Party Games (XXX)
81	UEDIT Word Processor	496	Holy Grail Adventure (1 Meg)
113	Maria Whittaker Slideshow (X)	517	Twisted Dreams (XXX)
152	Virus Killers	530	Morelove (XXX)
282	Forgotten Realms Slideshow	580	Dope Intro Maker
283	Mega Maid (XXX)	581	Jack The Nipper (XXX)
312	Bedroom Olympiad (XXX)	597	Fish 300
314	Breakout Construction Set	608	Fish 311
315	Return To Earth Game	646/647	Predators Megademo
399/400	NewTek Demo 3	656	NBS Animations Disk

★ SEND £1 FOR CATALOGUE DISK OR S.A.E. FOR LIST ★

★ YOU MUST STATE YOU ARE OVER 18 WHEN ORDERING (XXX) DISKS

Dept. AF, 145 Effingham Street, Rotherham,  
S. Yorkshire S65 1BL Telephone: (0709) 829286



# AMIGANUTS UNITED



LOW PRICES - HIGH QUALITY - FAST  
SERVICE - IN THE TRUE SPIRIT OF  
PUBLIC DOMAIN PRICES START AT  
ONLY 50p PLUS SELECTED FREE  
COPIES WITH EVERY TEN DISKS.



Amiganuts is the official UK Distributor of the T.Bag Disk Of The Month. Each issue is packed with music, utils, games, pictures, advice and help. Number 44 is the Latest issue available. Each issue is £1.60 inc P&P.

### HERE IS A SMALL SELECTION FROM THE THOUSANDS OF PROGS AVAILABLE

326 - (1) - Powerpacker (Simply the BEST Data/File cruncher)	521 - (2) - The Fantastic STAR TREK Game By T RICHTER
358 - (1) - Pirhana FISHTANK (Funny)	523 - (2) - Kefrens Megademo (1 MEG)
371 - (1) - Phoenix MIAMI MAN (game)	524 - (1) - Silents Megademo (1 MEG)
378 - (1) - The excellent ARP v.1.3 (utility)	525 - (1) - Star Trek (1 MEG) 1 disk. NO SAVE VERSION
389 - (1) - The hilarious PUGS IN SPACE (animation)	528 - (1) - The holy grail (1 MEG GAME)
392 - (1) - FLASCHBIER (game with full level editor)	542 - (1) - Bootblock champion III (excellent utility)
507 - (1) - 30 useful virus killers	551 - (1) - Sleepy. Animate Those Sleepy Icons. (CHARITYWARE), please support!
515 - (2) - Newtech demo reel 3 (1 MEG)	
515 - (1) - Rebels Megademo	

Prices are £1.65 PER disk, this includes return post/packing

NOTE: (\*) INDICATES NUMBER OF DISKS IN SET. (Example: - (2) - Requires £3.30)

### THE EIGHT DISKS LISTED BELOW ARE WORTH ADDING TO YOUR COLLECTION

**DISK 571:** MED V2.01e The best music player/editor available to date, it will load most soundtracker modules and it also supports Midi sequencing, (this is an update to V2, that is on Fred Fish 349, however, this one has all bugs fixed).

**DISK 576:** A special Education disk, packed with progs for the children.

**DISK 577:** Eight extremely helpful utilities for the hard drive user.

**DISK 580:** NCOMM V1.9. A nice updated Comms prog by D Bloch.

**DISK 581:** SID updated version 1.6 by Timm Martin, this dir utility is simply one of the best for those who find the CLI a pain in the ass!

**DISK 586:** The very latest (MAY 1990), Updates of Zerovirus/Brainfile III, Fullview V2.01, Plus 14 More, From The Australian Author Jonathon Potter.

**DISK 596:** 202, (YES 202!!!), utilities compiled by Gary of Pendle Europa

**DISK 599:** PONTONO. A well written version of this card game by Chris Labrum.

Note that Disks 571/576/577/580/581/586/596 and 599 are £2.00 each inc P&P

A VERY SPECIAL OFFER TO READERS OF THIS MONTHS AMIGA FORMAT T.BAG DISK OF THE MONTH PACK CONTAINING:ISSUE NUMBERS 39, 41, 42, 43, plus the special two disk issue number 40

FREE!!! AMIGA PEN WITH ALL ORDERS FOR THIS T.BAG OFFER FREE!!!

The best from the USA is offered to you for only £8.50 inc P&P  
JUST ENCLOSE £8.50 AND ASK FOR THE SPECIAL AMIGA FORMAT T BAG SET  
PLEASE NOTE THAT THIS OFFER CLOSES OCTOBER 1ST 1990

LATEST CATALOGUE DISK AVAILABLE AT £1.50 (INCLUDES P&P)

Make cheques/Postal Orders payable to: AMIGANUTS UNITED  
169, DALE VALLEY RD, HOLLYBROOK,  
SOUTHAMPTON SO1 6QX. PHONE 0703 785680  
PLEASE NOTE: Some demos contain language that may be considered offensive.

# Amiga P.D. Software only £1.50

**ST/Amiga Fanzine £1.00 + 20p P&P**  
ISSUE 7 with FREE Disk FREE P.D. List

**Sound Sampling for the ST/Amiga**  
£2.50 per disk (10 samples)

**Picture Digitizing for the Amiga**  
£3.00 per disk (6 pictures)

For details contact us at:-

**Sector 16 160 Hollow Way Cowley Oxford**  
Tel: 0865 777146

Please make Cheques / P.O.'s payable to ANDREW HAMILTON and SIMON GLEED



FAST, PROFESSIONAL  
AND FRIENDLY  
AMIGA PD SERVICE

HIGH QUALITY PUBLIC DOMAIN DISKS

## £2.00 OR LESS\*

Two Disk Catalogue £2.00

We'll get any PD disk for you - NO EXTRA CHARGE  
NO EXTRA FEES - Write for overseas postage  
FREE MONTHLY PRIZE DRAW  
ALL Libraries available (Fish, TBAG, AGATron etc.)  
Latest demos, animations etc.

Discount Hardware/Software/Disks etc.  
eg. PHOTON PAINT 2 £49.99 SONIX £39.99  
DIGMEW GOLD V4 Inc. DIGPAINT £119.99  
NEW Amiga BBS (0295) 275045 (24hrs)

\* Prices start at \$0000

Cheques/POs Payable to NOVA  
NOVA (AF7), 30 Parsons St, Banbury, Oxon OX16 8LY TEL (0295) 262029

# Pdom PD Amiga Software Pdom PD Amiga Software



## Graphics

**AMPI:** Home Business Pack, RIM the relational database and HyperBase database, UEdit the word processor which includes builtin help and tutorials, spell checkers, and VisiCalc the excellent spreadsheet. All auto loading.

A 3 disk pack for only £7.50!

**APDC 15** – Icon utilities: full of icon files and creators.

**AMICUS 22** – Printer Driver Generator V2.3.

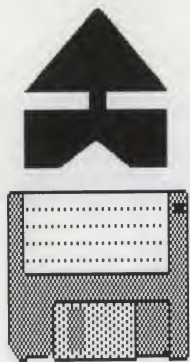

## Utility

**FFISH253** – Elements a display of the periodic table.

### FFISH258

**BACKUP** allows you to backup any hard disk path.

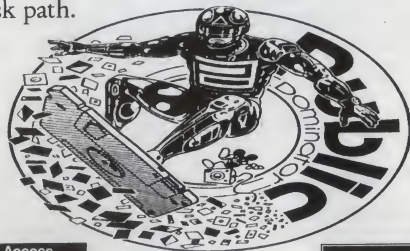

Access

VISA

Most of the disks in this advert actually contain more than is listed, for full details of all the disks, send for our disk catalogue, which costs only 70p fully inclusive! and allows fast and easy searching for items!

**AMP3 Graphics Pack 1** – Amiga MCAD excellent CAD package, VDraw brilliant painting program, Ray Tracer Generator, An object-orientated drawing package, IFF to pieces jigsaw program, ROT 3D drawing program. Loads of utilities. A 3 disk pack for only £7.50!

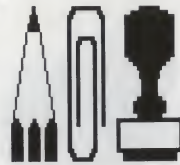

## Application

**APDC 18** – Floppy Disk Utils: Quick Copy, Disk Mapper, Disk Salvage, Virus Check, System Utils: Blitz text editor, TimeSet, ACalc a calculator, Amiga Monitor, MeM Grab fast memory grabber. DirectoryMaster. A must get disk for your Amiga P.D. collection! Excellent.

**FFISH 244** – Boot Intro you specify The headline text of upto 44 characters and the scrolling text of upto 300.

**PDOM 62** – The Public Dominator Anti Virus Disk: Virus X V4.0, VCheck V1.2 (for memory), VCheck V1.9 (for disk drives), Zero Virus V1.3 the fully integrated virus detector and killer. Also Boot Block Champion the utility.

**PDOM 65 and 66** – Red Sector Mega Demo. THE best demo on the Amiga! A 2 disk demo with the best sounds and graphics! A must!

**FAUG 41** – Amiga Arc V0.2 compatible with ARC V5.0.

**PDOM93** – ARP V1.3 Amiga DOS Replacement Project.

**FFISH 58** – ASDG a RAM disk that survives reset, Big View displays any size IFF picture, EGraph creates graphs from X,Y pair text files. NewZap disk sector editor. **FFISH 188** – Boot Intro V1.0 displays a scrolling and a still message of your choice at boot up.

**PDOM 86** – The Memory Expansions demo No1.

**PDOM 87** – The Memory Expansions demo 2. Both Require 1MB RAM.

**PDOM 73, 74 and 76:** The Star Trek Dry Dock Demo, Starship Enterprise demo and the Star Trek Shuttle demo. Amazing graphics.

**AMP21 Graphics Pack 2** – Mandelbrot Explorer, DBW Render a Ray Tracing utility, ST2IFF picture converter, HAM2IFF picture converter. Excellent value! A 3 disk pack for only £7.50.



## Games



**AMP8** – Games Pack 1 – Cluedo, Klondike, Canfield, Cribbage, Backgammon, Yahzee, Missile Command, 3D Breakout, Empire, Gravity Wars, Hanoi, Hockey, Jackland, Othello Master, Pacman, plus loads of other brilliant games. Amazing value!

A 3 disk pack £7.50!

**AMP22** – Games Pack 2 Escape from Jovi V3, Monopoly, Amoeba Space Invaders, Cosmo Roids, StoneAge, Back Gammon, Mastermind, Reversi, Black Jack, YachtC, Daleks plus loads of other brilliant games.

Amazing Value!  
3 disks for £7.50!

**PDOM150** – Scoopex Mental Hangover! THE best demo ever! AMFTC!

**PDOM79, 80 + 81** the StarTrek game! A brilliant three disk graphics game! Requires 1MB RAM.



## Demos



**PDOM 148** – Escape from Singes Castle an excellent demo of the game with fabulous animation! A mega follow up Space Ace!

**PD Disk Prices:** 1 to 5 disks are £3.00 each, 6 to 10 disks are £2.75 each and 11 or more disks are £2.50 each!  
Blank disks : 10-£7.00,  
50-£33.00.  
Disk cleaning kits – £2.50.

All prices are fully inclusive. To order please send a cheque or postal order payable to Pdom PD Amiga or Access & Visa credit card details to:  
Pdom PD Amiga Dept AF,  
P O Box 801  
Bishop's Stortford,  
Hertfordshire, CM23 3TZ.  
Telephone 0279 757692.

**L H A R C A  
PROGRAM:**

**FILES:** LHARCA.

LHARCA.DOC, ARP.LIBRARY,  
INSTALL\_ARP

Calling all you communications fanatics! Have we got a little scorcher for you! *LHARCA* is an archiving tool that has two features to recommended it. First, it's fully Intuition-based so you don't have to learn a massive list of dreaded command line arguments before you can even run the program. Secondly, it's pretty darned fast.

Although this is only a pre-release version, *LHARCA* is one mean mother in the speed department - If *LHARCA* is the Ferrari of compression utilities, then the rest are nothing more than Reliant Robins. So that you don't have to re-do all your old archives, *LHARCA* is 100% compatible with *LHARC* on the PC and most *Arc* utilities on the Amiga.

But why do I need an archiving program? I hear you ask. The answer is simple. Most bulletin boards include file sections that are packed with useful programs for your Amiga, all of which are (usually) freely available to be downloaded at your whim.

To save disk space, however, most (if not all) will be compressed in some form. The most common method of compression is 'arcing' (pronounced 'arking'). With *LHARCA*, you can download all those programs and decompress them with ease.

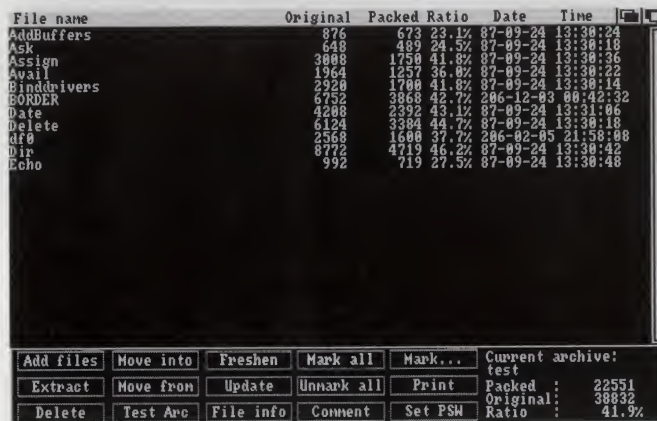
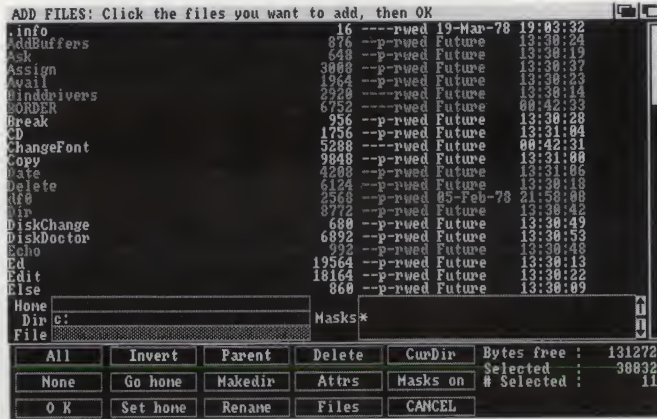

**Getting Started**

What can I say that you don't already know? Just double-click on the *LHARCA* icon and you're away. As always, full instructions are included within the same directory. However, if you've ever used an archiving utility before, then you probably won't need these at all - *LHARCA* really is that easy to use.

As *LHARCA* makes extensive use of MicroSmith's *Arp* library, this will have to be copied to the LIBS: directory of your boot disk. This can be achieved by double-clicking on the *Install\_Arp* program that can be found within the *LHARCA* drawer. This may involve some disk swapping, but once it is complete, you're ready to go.



**COPPER  
TUTORIAL**

**PROGRAM:** BY PAUL  
ANDREAS OVERAA  
**FILES:** COPPERTTEST,  
COPPERTTEST.C, CDSO

So you've already learned how being a good community policeman, how to help old grannies across the road and nick burglars before they get a chance to get up to no good. We've seen how, if you're a good bobby, they'll let you do the highway patrol and drive one of those really fast Cosworths that have those really neat flashing lights and sirens that go dee-derr, dee-derr and chase boy racers at such high speeds that the front of the cars start to glow...

Hang on a minute, something's up here - you'd never be able to get a whole Cosworth onto the *Amiga Format Coverdisk*...

**Getting Started**

Seriously though, there are two files to accompany the article to be found elsewhere within this issue of *Format*. *CopperTest* is a demo that shows how to accomplish copper colour bars from C and *CopperTest.c* is (obviously) the C source code for that very same demonstration program.

**M E N A C E   S O U R C E**

**PROGRAM:** DAVE JONES  
**FILES:** ALIENS, BONUS.S,  
GUARDIAN, MENACE,  
MENACE.S, MINE.S,  
PATHS.S, SHIPS.S

Everyone's favourite programmer, Dave Jones, the man everyone is calling, er, Dave Jones, returns again this month with another revealing chunk of source from Dave's monolithic *Menace*. This month, Dave has added the

'orrible tentacled end-of-level guardian that caused so many gameplayers to shout 'Eeek!, look at that end-of-level guardian'.

Some of you may have also noticed that the last lot of source code published for this article was incomplete. There should have been an extra file called ALIENS which somehow didn't (as such) make it to Coverdisk city. The good news is that we've bunged

the little fellow on as well, so your source code collection is now virtually complete and ready to go.

**Getting Started**

Dave's offering is starting to get rather large (ooer, missus!), so 512K Amiga owners may start to experience problems getting the executable to run from Workbench. To assure success every time, make sure that the

*Menace* executable is the first thing you load and that as many Workbench windows are closed as possible. Better still, drag the *Menace* icon out onto the Workbench screen, close the *Menace* window and then double-click on the *Menace* icon. If you still have problems loading the demo (ie, it won't), then turn off your machine for a while and then reload Workbench.

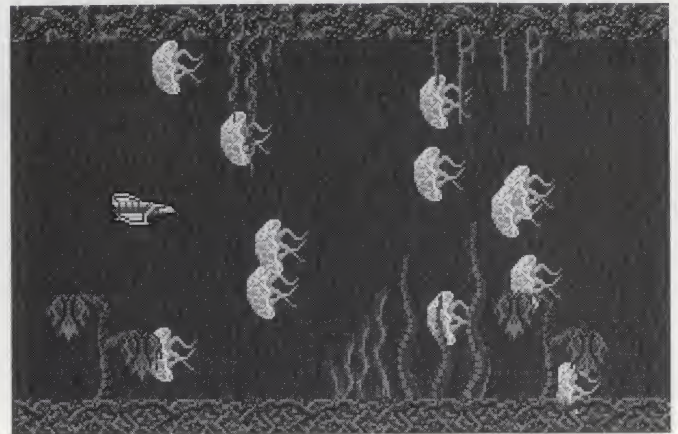
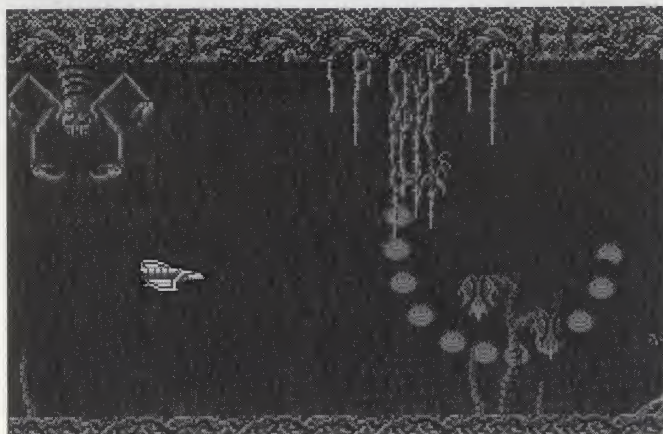

# USING YOUR FORMAT DISK

**IMPORTANT! Before using your Amiga Format disk, you should make a back-up of the master disk as soon as possible.**

## BACKING UP YOUR DISK

For many reasons, it is important to make a backup of the Coverdisk as soon as possible. Copying the disk may sound like a complicated task suitable for techno-buffs only, but it is surprisingly simple provided you read the following instructions carefully:

1. First, turn on your machine and load Workbench. Once the Workbench screen appears and the disk-drive light goes out, remove your Workbench disk and insert our Coverdisk.
2. Next, click once on the Coverdisk icon and then press the right mouse-button and the Workbench menus will appear. Now, while keeping the right mouse-button depressed, move the mouse pointer over to the 'Workbench' heading and a menu will drop down. Move the mouse pointer over the 'duplicate' menu option and then press the left mouse-button.
3. After a few seconds' disk access, the Workbench DiskCopy tool will be loaded and run. Now just follow the on-screen prompts and your Amiga Format Coverdisk will be copied to a backup disk. When the machine asks for the destination, insert your blank disk into the drive. Further instructions are in the user's guide that comes with your Amiga.

## USING THE PROGRAMS

All programs on the Amiga Format disk are specially set up to make them as easy to use as possible. If you can use the Amiga's Workbench then you can use our Coverdisk! If you do have problems with a program, full instructions on loading and using the programs are included in Disk Extra and these should get you up and running. If you still have problems, you should read the documentation file (.DOC) that is included

with every program. To run any of the programs on this month's Coverdisk, follow a simple procedure: unless specified differently within Disk Extra, just double-click on the program's icon on the Workbench and it will load and run. Full details on how to use the programs once they have loaded are included as a documentation (text) file with the program.

To display a documentation file, just double-click on the appropriate .DOC file and a window will open containing the file's contents. Pressing the space bar will advance the text a page at a time.

## COPYRIGHT NOTICE

Unless specifically stated, the programs on the Coverdisk are not in the public domain and the copyright remains with the author. Selling or distributing these programs without the author's permission is against the laws of copyright.

## DISK EXTRA HOTLINE

0225 765086

Between 4pm and 6pm on weekdays only

Flummoxed by files? Dumbfounded by disks? Paranoid about programs? If you have a problem with the disk – and you're sure the disk is in full working order – phone 0225 765086 with your query. State the model of your machine and anything you've got attached to (or plugged inside) the computer. For problems with disks before Issue 5 phone Amiga Format on 0225 442244.

## IS YOUR DISK FAULTY?

We have done our best to check that the programs on the Amiga Format Coverdisk are simple to use, error-free and have no known viruses. However, we cannot normally answer telephone queries on using the software, and we do not accept liability for any consequences of using the programs on the disk.

If your Amiga Format disk is faulty – and out of the tens of thousands duplicated, some are unfortunately bound to be – you should send it back for a free replacement within a month of the cover date to:

**Amiga Format  
August Disk  
P.C. Wise Ltd.  
Unit 3,  
Merthyr Industrial Park,  
Pentrebach,  
Merthyr Tydfil,  
Mid Glamorgan.  
CF48 4DR**

If your Amiga refuses to accept the disk, try using the DISK-DOCTOR utility on your Workbench disk to rescue it before sending it off for a replacement. Full details of DiskDoctor can be found in the user's manual that came with your machine.

## WE WANT YOUR PROGRAM

If you've got any programs for the Amiga which you think other readers would find useful, interesting or amusing, we'd very much like to know about them.

1. Make sure your program is fool-proof to use.
2. Create a file called README.DOC on the disk which explains exactly how to use your program.
3. Fill in this form, sign it, and send it without delay to: Coverdisk Software, Amiga Format, 30 Monmouth Street, BATH BA1 2AP. You could win a share of up to £800 prize money for the best programs each month.

## EARN UP TO £800

Name.....  
.....  
Address.....  
.....  
Telephone (Daytime).....  
(Evenings).....  
My program name is.....  
.....

Brief description.....  
.....  
.....

### Checklist (please tick):

- Stamped, addressed envelope for return
- README.DOC explanation file on disk
- Printout of README.DOC file (if possible)
- Name, address, machine type written on label
- Disk certified virus free

Approximate total size of files in kilobytes .....K  
(we cannot use programs longer than 200K; shorter submissions, under 100K, stand the best chance of publication). It is a:

- Game
- Business utility
- Music program
- Novelty
- Technical tool
- Art program
- Educational
- Other

### IMPORTANT Please sign this declaration:

This program is submitted for publication by Amiga Format. It is wholly my own work and I agree to indemnify Future Publishing against any possible legal action should copyright problems arise.

Signed .....

Date .....

## STEREO SAMPLER MK II —

IT'S FAST & IT MAKES ALL OTHER SAMPLERS OBSOLETE!

WHICH OTHERS HAVE A PRINTER THROUGH PORT?



STEREO SAMPLER MK II  
INTRODUCTORY PRICE — **£39.99**

**SAVE £5.00** (RRP £44.99)  
SAMPLER + AUDIOMASTER II  
— SPECIAL OFFER **£99.99**  
SAVE **£29.99**

AUTOMATIC PRINTER ADAPTOR ..... **£14.99**  
Our superb MONO SAMPLER is still available — **Only £27.99**

- USES LATEST STATE OF THE ART A/D CHIP
- VERY SHORT CONVERSION TIME < 1µSEC
- VERY HIGH SAMPLE RATES > 500KHz (Amiga & software dependent)
- SUPERB QUALITY ESPECIALLY WITH CD AUDIO
  - EASILY ADJUSTED INPUT LEVEL CONTROL (no screwdriver required)

- PRINTER THROUGH PORT — A MAJOR INNOVATION\*
- CONNECTS TO PARALLEL PORT ONLY.
- COMPATIBLE WITH MOST SAMPLER SOFTWARE inc Audiomaster I & II, Perfect Sound, Future Sound, Prosound, Quasar Sound, etc etc
- FREE PD DISK & CONNECTING LEAD

\* THIS MAJOR INNOVATION MEANS THAT THE SAMPLER CAN BE LEFT CONNECTED AT ALL TIMES EVEN WHEN NOT IN USE. Your existing printer lead is connected to the sampler via our low cost AUTOMATIC PRINTER ADAPTOR, then whenever you want to print just switch the printer on-line. Switch it off-line to use the sampler — what could be simpler.

## MINIAMP 4 STEREO SPEAKER SYSTEM

OUR MINI HIFI SYSTEMS ARE IDEAL FOR YOUR AMIGA ATARI STE, ARCHIMEDES & PERSONAL STEREO ETC.

- SUPERB LOW DISTORTION STEREO SOUND
- NEW IMPROVED 'BRIDGE' DESIGN STEREO AMPLIFIER
- MORE POWER — NOW APPROX 5 WATTS PER CHANNEL
- 2 PIN DIN SPEAKER SOCKETS (SUITABLE FOR MOST HIFI SPEAKERS)
- COMPACT QUALITY TWIN CONE SPEAKER UNITS WITH 6' LEADS
- MAINS POWER PACK — DOESN'T USE ANY COMPUTER POWER
- SIMPLE TO CONNECT — JUST PLUG IN & SWITCH ON
- PLEASE STATE COMPUTER WHEN ORDERING
- FREE MAINS POWER UNIT WORTH £5.99

MINIAMP 4 COMPLETE..... **£44.99**  
MINIAMP 4 LESS SPEAKERS. **£29.99**



(SENT FREE WITH EVERY ORDER)

**FREE**  
48 PAGE AMIGA SUPERMARKET CATALOGUE

WRITE OR PHONE FOR YOUR COPY NOW!  
LISTS VIRTUALLY EVERYTHING YOU COULD WANT FOR YOUR AMIGA INCLUDING:-

- MONITORS & PRINTERS
- DISK DRIVES
- DUST COVERS

THERE'S A WHOLE WORLD OF NEW  
**THE AMIGA SUPERMARKET!**  
DISCOVERIES IN STORE FOR YOU AT

• RIBBONS & PAPER • PRINTER, MONITOR, MODEM & MANY OTHER TYPES OF LEAD • DISCOUNT AMIGA SOFTWARE • AMIGA BOOKS • JOYSTICKS • DISKS & DISK BOXES

## AMIGA TRACKERBALL

YOU'LL NEVER USE A MOUSE AGAIN! **£54.95**

- PRECISE CURSOR CONTROL
- EFFORTLESS FINGER TIP OPERATION
- RAPID POINT TO POINT MOVEMENT
- QUALITY ENGINEERING — DEVELOPED FROM AEROSPACE VERSIONS
- POSITIVE ACTION PUSH BUTTONS
- JUST PLUGS IN — NO SOFTWARE NEEDED.



### AMIGA MOUSE

- FULLY COMPATIBLE
- VERY RELIABLE
- FREE MOUSE MAT
- FREE MOUSE HOLDER

**£29.99**

### RETURN OF POST MAILORDER SERVICE

ALL PRICES INCLUDE VAT ORDERS OVER £15.00 ARE POST FREE. EXPRESS DELIVERY: £1.99 EXTRA, except disk drives & Miniamp 4 — add £5.00 for fast carrier delivery on these items.

### HOW TO ORDER BY POST:

Make cheques/POs payable to TRILOGIC, adding 75p post & packing if your order total is less than £15.00

### BY PHONE:

on 0274 - 691115. Phone your order before 2pm, quoting your Access or Visa number & we'll despatch it the same day (unless the item is out of stock). (You're not charged until your order is despatched.)

### BY FAX:

on 0274 600150. Quote your card number & full order & delivery details. (You're not charged until your order is despatched.)

### EXPORTS A SPECIALITY

By post — Send payment in sterling made payable to TRILOGIC, adding £1.99 for surface mail or £3.99 for airmail. Or by phone using Mastercard or Visa.

CALLERS ARE WELCOME — please phone first to check availability.

- PLUGS INTO THE SCART SOCKET OF YOUR TV OR MONITOR
- DUAL SCART SOCKETS FOR TWO COMPUTERS OR ...
- COMPUTER + VCR OR ...
- COMPUTER + SATELLITE RECEIVER ETC
- PUSH BUTTON SWITCH SELECTS INPUT 1 OR INPUT 2
- NO ADDITIONAL LEADS REQUIRED — YOUR EXISTING SCART LEADS JUST PLUG INTO THE SHARER

## MONITOR SHARER

**£15.99**  
GIVES YOUR TV or MONITOR TWO SCART INPUTS.

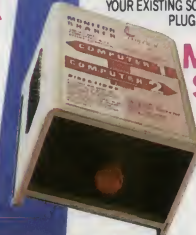

## EXTERNAL 3.5" DISK DRIVE

**£74.99**

- 880K FORMATTED, 1MEG UNFORMATTED
- THROUGH PORT FOR CONNECTION OF ADDITIONAL DRIVES
- ON/OFF SWITCH
- SLIMLINE STEEL CASE
- LOW POWER CONSUMPTION
- EXTREMELY QUIET OPERATION
- VERY RELIABLE NEG MECHANISM

ALSO AVAILABLE... CUMANA CAX354 **£84.99**  
CUMANA CAX1000S 51/4" DRIVE **£129.99**  
INTERNAL REPLACEMENT DRIVE (Chinon type only) **£79.99**

## 1/2MEG UPGRADE

**£69.99**



- CLOCK & BATTERY
  - ON/OFF SWITCH
  - USES LOW POWER CMOS D-RAMS
  - EASY TO FIT
  - ALL CHIPS SOCKETED
- WITHOUT CLOCK & BATTERY **£64.99**

## MOUSE JOYSTICK SWITCH



- CONNECTS IN PLACE OF MOUSE (OR JOYSTICK)
- FEATURES TWO SOCKETS WITH PUSH BUTTON SELECTION OF MOUSE OR JOYSTICK

## MIDI INTERFACE

**£34.99** 2



- SWITCH CAN BE OPERATED AT ANY TIME
- SUITABLE FOR USE WITH MOST DONGLES
- DOES NOT USE ANY POWER
- REDUCES WEAR & TEAR ON COMPUTER'S PORTS
- MAKES ACCESS EASIER
- SUITABLE FOR AMIGA, ST ETC

**£14.99**  
NO MORE UNPLUGGING THE MOUSE

THE MOST VERSATILE MIDI INTERFACE AVAILABLE AS SUPPLIED TO COMMODORE FOR THE CLASS OF 906 PACK

- 1. MIDI IN SOCKET
- 1. MIDI THROUGH SOCKET
- 1. MIDI OUT SOCKET
- 2. SWITCHABLE OUT/THRU SOCKETS FOR ADDITIONAL INSTRUMENTS, GIVING EFFECTIVELY 3 OUTS OR 3 THRU'S OR 2 OF EACH — HOW'S THAT FOR VERSATILITY
- FULLY OPTO ISOLATED
- VERY LOW POWER CONSUMPTION
- COMPATIBLE WITH AMIGA 2000, A1000 VERSION AVAILABLE AT NO EXTRA COST
- COMPATIBLE WITH MUSIC X, Dr T'S, DELUXE MUSIC, SONIX, ETC
- ADDITIONAL 3m MIDI LEAD **£3.99**

SIMPLER VERSION WITH 1 EACH OF MIDI IN, OUT & THRU SOCKETS **ONLY £29.99**

# MEDIA DIRECT

## NOW INCORPORATING



TO OFFER YOU A HIGH QUALITY SERVICE AND PRODUCT RANGE

### COMPUTER SUPPLIES

#### COMPETITION PRO JOYSTICKS

IN YOUR FAVOURITE TEAMS

#### WORLD CUP SERIES

England.....	£12.95
Brazil.....	£12.95
Italy.....	£12.95
Spain.....	£12.95
Belgium.....	£12.95
Holland.....	£12.95
Sweden.....	£12.95
West Germany.....	£12.95
USA.....	£12.95
Scotland.....	£12.95

# 3 1/2" DSDD DISKS

100% CERTIFIED ERROR FREE

PRICE INCLUDES VAT & LABELS

ALL OUR DISKS ARE FULLY GUARANTEED

# 40p

ABOVE DISKS ARE OF THE HIGHEST QUALITY MANUFACTURED BY MITSUBISHI OR VERBATIM

#### FOR BULK BUYERS

500 DSDD Disks 135 tpi.....	£187.50
700 DSDD Disks 135 tpi.....	£277.50
1000 DSDD Disks 135 tpi.....	£360.00

#### ★★★★ SPECIAL OFFER★★★★

200 DSDD Disks 135 tpi + 2 X 100 Cap Boxes £86.95

PLEASE NOTE:- 100 CAP BOXES BOUGHT WITH DISKS £4.50

#### SONY BULK 3 1/2" DSDD DISKS AND BOXES

25 DSDD Disks.....	£13.75 + 100 Cap Box.....	£18.25
50 DSDD Disks.....	£26.50 + 100 Cap Box.....	£31.00
75 DSDD Disks.....	£38.65 + 100 Cap Box.....	£43.15
100 DSDD Disks.....	£49.95 + 100 Cap Box.....	£54.45
150 DSDD Disks.....	£73.50 + 100 Cap Box.....	£78.00

500 DSDD DISKS £240.00. 1000 DISKS £465.00

#### AMIGA 512K EXPANSION

INCLUDING MEMORY DISABLE SWITCH

### £46.50

INCLUDING BATTERY BACKED CLOCK

#### DISK STORAGE BOXES

3 1/2" 100 cap.....	£5.50
3 1/2" 10 cap.....	95p
10 for.....	£7.50
5 1/4" 100 cap.....	£5.50

#### STACKABLE BOXES

3 1/2" 80 cap (Baux)	
1.....	£9.00 each
3+.....	£8.50 each
5+.....	£8.00 each
3 1/2" 150 cap (Posso)	
<b>£15.95 each</b>	

#### PUBLIC DOMAIN

UTILITIES, GRAPHIC SOFTWARE, MUSIC SOFTWARE, GRAPHICS DEMOS, MUSIC DEMOS

HUNDREDS OF DISKS IN STOCK SEND FOR FREE CATALOGUE

**£1.20** per disk

10 PD DISKS IN PLASTIC BOX

**£9.95**

PLEASE NOTE:- P.D DISK PRICES INCLUDE P&P

#### ACCESSORIES

Mouse Mats.....	£2.95
3 1/2" Cleaning Kits.....	£1.80
Mouse Pockets.....	£1.50
Labels per 1000.....	£7.95
5 1/4" Cleaning Kits.....	£1.80

#### 5 1/4" DSDD DISKS

25.....	£7.50
50.....	£14.75
75.....	£21.00
100.....	£26.50
500.....	£130.00
1000.....	£249.00

#### 5 1/4" DSHD DISKS

25.....	£15.50
50.....	£30.50
75.....	£44.50
100.....	£57.00
500.....	£275.00
1000.....	£530.00

3 1/2" HIGH DENSITY DISKS  
**£1.00 EACH**

Please add £2.95 P&P per order. Next day £10.00  
Cheques/PO's to MEDIA DIRECT DEPT AFT  
11 SAGE CLOSE, HANLEY  
S-O-T ST1 3SF  
TELESALES HOTLINES 0782 208228



# Special Reserve

CAN YOU AFFORD

NOT TO JOIN?

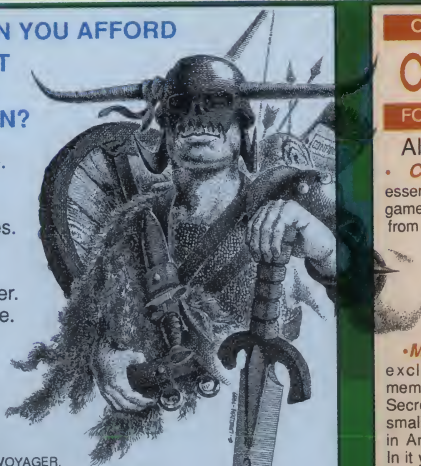

OR JOIN EUROPE'S BIGGEST ADVENTURE CLUB

## OFFICIAL SECRETS

FOR ADVENTURES AND ROLE PLAYING AND MORE

All the benefits of Special Reserve plus:

- Confidential.** Our 32 page bi-monthly magazine is essential reading for those interested in adventures or role playing games. Written by experts, *Confidential* has covered everything from How to Host a Murder to Which F16 Flight Simulator? Our agents, led by the Master Spy known as "The Boss Upstairs", seek out the secrets of RPG's, FRP's, MUG's, PBM's, Leisure Suit Larry, The Russians, Elvira... & more.
- Note:** You can subscribe to Confidential without joining the clubs for £15.00 (UK) by entering "CONFIDENTIAL SUBSCRIPTION" on the order form.
- Myth.** Written by Magnetic Scrolls, authors of The Pawn, exclusively for members of Official Secrets. Myth is a small adventure set in Ancient Greece. In it you'll meet The Ferryman, cheat Death and face the nine-headed Hydra. Myth includes the famous Magnetic Scrolls parser and graphics and is included in the price of membership.

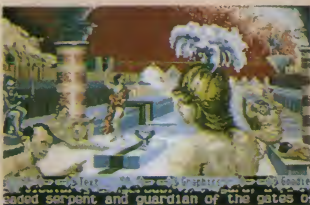

**Amiga Format said:** "An excellent adventure... witty, cunning and just plain good fun! If you liked Fish! you'll probably like this, because they're very similar in style: you may even prefer Myth, it's that good!"

**Myth Ratings:** Crash 91%, CU 90%, Amiga Format 87%, TGM 85%

**Of Drakkhen, ST Action said:** "Drakkhen really impressed me. For me, the game was a subtle cross between my all-time favourite, Dungeon Master, and the SSI fantasy role-playing games. The graphics are superb.... Overall, Drakkhen is an excellent RPG, one that will take quite some time to beat" and **Zero said:** "Absolutely brilliant!"

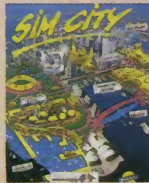

**Of Sim City, ACE said:** "Sim City is a politician's - or a gamer's dream... comparisons ring immediately to mind with Populous... but Sim City seems to have much more depth...." and **C&VG said:** "Sim City is utterly fab"

**Help-Line.** Manned weekdays until 8pm and Sundays - with solutions to most adventures.

Annual UK Official Secrets Membership including 6 issues of Confidential, Myth, Drakkhen or Sim City, Help-Line and Special Reserve membership. **27.99**

SALES LINE 0279 600204.

PLEASE NOTE THAT THERE IS A SURCHARGE OF 50P PER GAME FOR ORDERS PLACED BY TELEPHONE.

Name & Address \_\_\_\_\_

Post Code \_\_\_\_\_ Tel. \_\_\_\_\_

Computer \_\_\_\_\_ \*5.25"/3.5"/  
\_\_\_\_\_ \*3.0"/TAPE

## Special Reserve or Official Secrets

P.O. Box 847, Harlow, CM21 9PH

Existing members please enter your Membership No. \_\_\_\_\_

Special Reserve £5 UK, £6 EEC, £7 World or Official Secrets £27.99 UK, £32 EEC, £36 World

with Drakkhen  or with Sim City  AMIGA 2  
and Myth  and Myth

PLEASE ENTER MEMBERSHIP FEE £ \_\_\_\_\_

Item £ \_\_\_\_\_

Item £ \_\_\_\_\_

Item £ \_\_\_\_\_

Credit card expiry date \_\_\_\_\_

\*CHEQUE\*/POSTAL ORDER\*/ACCESS\*/VISA

- Bi-monthly *Buyer's Guides*, each with reviews of 40 games and more.
- *Release Schedules*, bi-monthly, with advance release information.
- *7-day hotline*, to 8pm weekdays, 10-5.30 Saturdays, 11-5 Sundays.
- *Fast despatch* of stock items. Most lines from our stock of 40,000 games.
- *Catalogue, Membership Card & Folder* for the Buyer's Guides.
- Games sent *individually wrapped by first class post*.
- *Written confirmations* (and receipts) sent when we receive each order.
- *Refunds, or change of order* on request, if there is a delay just phone.
- *No commitment, no obligation to buy anything (unlike others).*
- *The best games*, available at the *best prices*. That's why over 20,000 members have already joined *Special Reserve*.

## Amiga Software

688 ATTACK SUB	16.99	F19 STEALTH FIGHTER	18.99	LIGHT FORCE (R-TYPE, VOYAGER,	
ADIDAS CHAMP FOOTBALL	15.99	F29 RETALIATOR	15.99	BIO-CHALLENGE, Ik+)	15.99
AMOS (GAMES CREATOR)	28.99	FERRARI FORMULA 1	16.49	LURKING HORROR (INFOCOM)	24.99
AMOS VIDI DIGITISER	51.49	FINAL BATTLE	15.99	MANCHESTER UNITED	15.99
ANARCHY	15.99	FIRE AHEAD	16.49	MANHATTAN SAN FRANCISCO	21.99
B.S.S. JAMES SEYMOUR	16.99	FLIGHT SIM 2 WEST EUROPE	16.49	MANIAC MANSION	16.99
BACK TO THE FUTURE 2	15.99	SCENERY DISK	13.99	MAVIS BEACON TYPING	17.99
BACKGAMMON PRO	14.99	FLIGHT SIMULATOR 2	25.49	MIDNIGHT RESISTANCE	16.49
BALANCE OF POWER 1990	15.49	FOOTBALL DIRECTOR 2	12.99	MIDWINTER	18.99
BARDS TALE 1	7.99	FULL METAL PLANETE	15.49	MIGHT AND MAGIC 2	19.99
BARDS TALE 2	16.49	FUN SCHOOL 3 (2-5 YRS)	15.49	MOONMIST (INFOCOM)	17.99
BATMAN THE MOVIE	15.99	FUN SCHOOL 3 (5-7 YRS)	15.49	NANUK	12.99
BATTLE OF BRITAIN	19.99	FUN SCHOOL 3 (7+ YRS)	15.49	NINJA SPIRIT	15.99
BATTLE CHESS	16.49	FUTURE WARS	17.49	NINJA WARRIORS	16.49
BATTLEHORNS 1942	16.49	GAUNTLET 2	7.99	NUCLEAR WAR	16.99
BEYOND ZORK (INFOCOM)	24.99	GHOLTS N' GHOSTS	16.49	OMNI-PLAY BASKETBALL	15.49
BLADE WARRIOR	15.99	GO PLAYER PROFESSIONAL	19.99	OMNI-PLAY HORSE RACING	15.49
BLOODWYCH DATA DISK	9.99	GRAND PRIX CIRCUIT	16.49	OPERATION THUNDERBOLT	15.49
BOMBER	18.49	GREG NORMAN'S GOLF	16.99	PAPERBOY	99.99
BOMBER MISSION DISK	19.99	GRIDIRON (U.S FOOTBALL)	15.49	PHANTASIE 3 (SSI)	17.49
BODENNAME ICEMAN	24.99	GUNSHIP	15.99	PHOTON PAINT 2.0 (1 MEG)	49.99
BUDOKAN	16.49	HAMMERFIST	15.99	PIPEMANIA	15.49
CABAL	15.49	HARLEY DAVIDSON	15.49	PIRATES	15.99
CARTOON CAPERS	12.49	HERO'S QUEST (1 MEG)	21.99	PLAYER MANAGER	12.49
CASTLE MASTER	15.99	HITCH HIKERS GUIDE	39.99	POLICE QUEST 1 (SIERRA)	15.99
CHASE H.Q.	15.99	HOLLYWOOD HUNK	15.49	POLICE QUEST 2 (SIERRA)	21.99
CHESS CHAMPION 2175	19.99	HOM OFFICE KIT (KIND	19.99	POPULOUS	16.49
CODENAME ICEMAN	24.99	WORDS 2.0, MAXI PLAN, INFO		POPULOUS PROMISED LANDS	7.99
COLONEL'S BEQUEST	24.49	FILE, PAGESETTER, ARTISTS'		POWERDROME	16.49
COLORADO	15.99	CHOICE, FONTS)	86.49	PRO TENNIS TOUR	16.49
COLOSSUS CHESS X	15.49	HOUND OF SHADOW	16.99	PROTEXT WORD PROCESSOR	64.99
CONQUEROR	15.99	HOYLES BOOK OF GAMES	21.99	PUBLISHERS CHOICE DTP (KIND	
CRACK DOWN	16.99	IMPERIUM	16.99	WORDS 2, PAGESETTER 1, 2,	
CYBERBALL	12.99	KING OF LIONS ADVENTURE	16.99	LASER SCRIPT (1 MEG)	59.99
DAMOCLES	15.49	INFESTATION	15.49	RAINBOW ISLAND	15.99
DATA STORM	12.49	INFIDEL (INFOCOM)	16.49	RAMROD	16.99
DEBUT (PLANET SIMULATION)	15.49	INTERNATIONAL 3D TENNIS	16.49	RED STORM RISING	16.49
DEJA VU	15.49	IRON LORD	16.49	RESOLUTION 101	15.99
DEJA VU 2	15.49	IT CAME FROM THE		RISK	12.49
DELUXE MUSIC CONSTR SET	46.47	DESERT DATA DISK (1 MEG)	10.49	ROBOTOP	15.49
DELUXE PAINT III	51.49	JACK NICKLAUS GOLF	16.49	ROTCOP	15.49
DOUBLE DRAGON 2	13.49	JACK NICKLAUS GOLF DATA 1	8.99	ROURKE'S DRIFT	15.99
DRAGON NINJA	15.99	JUMPING JACKSON	12.49	SCAPEGHOST (LEVEL 9)	12.49
DRAGON'S LAIR (1 MEG)	28.49	KICK OFF	12.49	SCRABBLE DE LUXE	12.99
DRAGON'S BREATH	18.99	KICK OFF 2	12.49	SEASTALKER (INFOCOM)	17.99
DRIVING FORCE	16.49	KICK OFF EXPANSION DISK	7.49	SECRET AGENT SLY SPY	15.99
DUNGEON MASTER EDITOR	7.49	KING OF LIONS ADVENTURE	20.99	SHADOX WARRIORS	15.99
DYNAMIC DEBUGGER	16.49	KINGS QUEST 1, 2 & 3	21.49	SHADOWGATE	15.49
DYNASTY WARS	16.99	KINGS QUEST 4 (SIERRA)	21.49	SHERMAN EM	16.99
DYER	12.49	KLAX	12.99	SHOOT 'EM-UP CONSTR' KIT	18.49
E-MOTION	16.99	KNIGHTS OF CRYSTALLION	19.99	SIM CITY TERRAIN EDITOR	9.99
ELVIRA - MISTRESS OF THE DARK	19.49	LEADERBOARD BIRDIE	16.49	SPACE ACE	27.49
ENCHANTER (INFOCOM)	18.49	LEISURE SUIT LARRY 1	18.99	SPACE QUEST 1 (SIERRA)	16.49
ESCAPE FRM SINGES CASTLE	28.49	LEISURE SUIT LARRY 2	21.49	SPACE QUEST 2 (SIERRA)	16.49
ESCAPE FROM THE PLANET OF		LEISURE SUIT LARRY 3	24.49	STARBLADE	16.49
THE ROBOT MONSTERS	12.99	LIFE AND DEATH	15.49	STARCROSS (INFOCOM)	24.99
EUROPEAN SUPER LEAGUE	15.49			STARFLIGHT	16.99
F16 COMBAT PILOT	15.99			STARTER KIT (KIND	

SONY 3.5" DS/DD DISKS 69p each

INEVITABLY, SOME OF THE ABOVE GAMES MAY NOT YET BE RELEASED. ALL GAMES ARE DESPATCHED AS SOON AS POSSIBLE.  
Special Reserve and Official Secrets are trading names of Inter-Mediates Ltd. Registered in England Number 2054713.  
Reg. Office: 2 South Block, The Maltings, Sawbridgeworth, Herts CM21 9PG. VAT reg. no. 424 8532 51

## Amiga Mega-Savers

ADVENTURE CONSTRUCTION KIT	13.99	KRISTAL	8.99
ALTERED BEAST	7.49	KULT	7.49
ARKANOID	10.49	LANCELOT (LEVEL 9)	8.99
AUSTERLITZ (BATTLE OF)	11.99	LASER SQUAD	7.99
BAAL	6.99	LEATHER GODDESSES (INFOCOM)	9.99
BALLISTIX	6.49	LEATHERNECKS	5.99
BATTLE SQUADRON	13.49	LOMBARD RAC RALLY	10.49
BLACK CAULDRON	7.99	LORDS OF THE RISING SUN	9.99
BLACK LAMP	6.99	MENACE	4.99
BLOOD MONEY	7.49	MICROPROSE SOCCER	8.49
BLOODWYCH	7.49	MILLENIUM 2.2	6.99
BUGGY BOY	9.49	NEW ZEALAND STORY	6.99
CAPTAIN BLOOD	7.99	NORWAY'S GRAND PRIX	10.49
CARRIER COMMAND	7.99	PACLAAND	5.99
CHESSMASTER 2000	8.49	PACMANIA	6.49
CHRONQUEST 2	9.49	PASSING SHOT (TENNIS)	8.49
CLOUD KINGDOMS	7.99	PAWN (M/SCROLLS)	9.99
CONFLICT EUROPE	6.99	PHOTON PAINT	6.49
CONTINENTAL CIRCUS	11.49	POWER DRIFT	4.99
CUTTHROATS (INFOCOM)	15.49	PURPLE SATURN DAY	7.49
DRAKKHEN	13.99	ROCKET RANGER	8.99
DUNGEON MASTER (1 MEG)	9.99	SHADOW OF THE BEAST + T-SHIRT	11.49
DYNAMIC DUX	7.49	SHOGUN (INFOCOM)	9.99
EDDIE EDWARDS SUPER SKI	4.99	SIM CITY	13.99
ELIMINATOR (1.2 AMIGAS ONLY)	4.49	SKYCHASE	6.49
ELITE	9.99	SKYFOX	5.49
EYE OF HORUS	5.99	SPEEDBALL	6.49
F16 FALCON	12.99	STARGLIDER	6.49
F16 FALCON MISSION DISK	7.99	STARGLIDER 2	11.49
FAST BREAK (VOLLEYBALL)	6.49	SUPER WONDERBOY	7.99
FISH! (M/SCROLLS)	9.99	SWORD OF SODAN	7.99
FOOTBALL MANAGER 2 + EXP	10.99	TEENAGE QUEEN (STRIP POKER)	8.49
FOOTBALL MNGR WORLD CUP	10.99	THREE STOOGES (CINEMAWARE)	6.99
FUN SCHOOL 2 2-6, 6-8 or 8+	7.99	TIME & MAGIK (LEVEL 9)	7.99
GUILD OF THIEVES (M/SCROLLS)	9.99	TRIAD VOL 2 (MENACE, BAAL, TETRIS)	7.99
HARD DRIVIN'	9.99	TRIAL PURSUIT	8.49
HIT DISKS VOLUME 2	8.49	TURBO	6.49
HOSTAGES	7.49	TV SPORTS BASKETBALL	11.99
HYBRIS	5.99	TV SPORTS FOOTBALL (U.S.A.)	11.99
INDIANA JONES ACTION	11.49	UMS - UNIVERSAL MILITARY SIM.	7.49
INTERNATIONAL KARATE +	7.49	VIRUS	6.99
IT CAME FROM THE DESERT (1 MEG)	10.99	WATERLOO	10.49
JINXTER (M/SCROLLS)	9.99	WHO FRAMED ROGER RABBIT	9.99
KID GLOVES	7.49	XENON 2, MEGABLAST	6.99
KING OF CHICAGO	11.99		

BEAST + SHIRT	11.49
POWER DRIFT	4.99
XENON II	6.99

## Special Reserve or Official Secrets

P.O. Box 847, Harlow, CM21 9PH

Existing members please enter your Membership No. \_\_\_\_\_

Special Reserve £5 UK, £6 EEC, £7 World or Official Secrets £27.99 UK, £32 EEC, £36 World

with Drakkhen  or with Sim City  AMIGA 2  
and Myth  and Myth

PLEASE ENTER MEMBERSHIP FEE £ \_\_\_\_\_

Item £ \_\_\_\_\_

Item £ \_\_\_\_\_

Item £ \_\_\_\_\_

Credit card expiry date \_\_\_\_\_

\*CHEQUE\*/POSTAL ORDER\*/ACCESS\*/VISA

# Dowling

MAIL ORDER DIVISION

# COMPUTERS

HEAD OFFICE:

Unit 48  
Tyne Road  
Sandy, Beds, SG19 1RB  
Tel: 0767 681750/60  
Fax: 0767 681730



ALL PRICES INC VAT PLUS A FULL 1 YEAR GUARANTEE

## AMIGA DEALS

**STANDARD PACK**:- Amiga 500 computer, Mouse, Modulator, Power Supply, Operating Manuals & Disks etc **ONLY £339.95**

TENSTAR GAMES PACK - ONLY AVAILABLE WHEN PURCHASING AN AMIGA

**★TEN STAR★** COMPRISING ★ Ikari Warriors ★ Buggy Boy ★ Wizball ★ Terrorpods ★ Barbarian ★ Thundercats ★ Art of Chess ★ Amegas ★ Insanity Flight ★ Mercenary

ALL TEN GAMES FOR JUST **£24.95**

BATMAN PACK +	FLIGHT OF FANTASY +	ULTIMATE GAMES PACK
<ul style="list-style-type: none"> <li>★ Amiga Computer as in Standard Pack</li> <li>★ Batman The Movie</li> <li>★ F18 Interceptor</li> <li>★ New Zealand Story</li> <li>★ Deluxe Paint II</li> <li>★ Tenstar Games Pack</li> </ul>	<ul style="list-style-type: none"> <li>★ Amiga computer as in Standard Pack</li> <li>★ F29 Retaliator</li> <li>★ Rainbow Islands</li> <li>★ Escape from the Planet of the Robot Monster</li> <li>★ Deluxe Paint II</li> <li>★ Tenstar Games Pack</li> </ul>	<ul style="list-style-type: none"> <li>★ Amiga Computer as in Standard Pack</li> <li>★ F29 Retaliator</li> <li>★ Rainbow Islands</li> <li>★ Batman The Movie</li> <li>★ F18 Interceptor</li> <li>★ New Zealand Story</li> <li>★ Deluxe Paint II</li> <li>★ Escape from the planet of the Robot Monster</li> <li>★ Tenstar Games Pack</li> <li>★ Megablastor Joystick</li> <li>★ High Quality Dust Cover</li> <li>★ High quality mouse Mat</li> </ul>
ONLY <b>£369.95</b>	ONLY <b>£369.95</b>	ONLY <b>£399.95</b>

## NEW PROFESSIONAL BUSINESS PACK

★ Amiga 500 computer as in standard pack.  
★ Kindwords II wordprocessor (RRP £49.95)  
★ Superbase Personal II, Database (RRP £99.95)  
★ Maxiplan Spreadsheet (RRP £99.95)  
★ Box of ten MF2DD branded disks (RRP £12.99)  
This pack usually sells for over £660

**OUR PRICE £429.95**

## NEW PROFESSIONAL ART & MUSIC PACK

★ Amiga 500 computer as in standard pack  
★ Music X software package (RRP £229.95)  
★ Photon Paint II - latest version (RRP £79.95)  
This pack usually sells for over £700

NB: Music X is the full blown UK version, do not confuse with inferior versions or "Music X Junior"

**OUR PRICE £429.95**

THE **Star** COMPUTER PRINTERS



Being Star registered dealers we only sell official UK machines which come with a full 1 year guarantee. Beware of inferior imported products

OFFICIAL U.K VERSIONS	RRP	OUR PRICE
STAR LC10 mono 144/36 C.P.S	£229.95	£149.95
STAR LC10 II 25% faster version	£263.35	£169.95
STAR LC10 Colour, 7 colours	£297.85	£189.95
STAR LC24-10- 24 pin multifont	£343.85	£229.95
STAR LC10 Sheet Feeder (auto)	£74.75	£59.95
STAR LC10 Mono Ribbons	£5.95	£3.95
STAR LC10 Colour Ribbons	£7.95	£5.95
STAR LC24-10 Ribbons	£7.95	£5.95
STAR LC10 Quality Dust Cover	£7.95	£5.95



## MUSIC SCOOP



We have packaged the best MUSIC SOFTWARE for the Amiga together with the best MIDI interface on the market. Look at what you get: **MUSIC-X** widely acclaimed as the most comprehensive and easy to use professional music utility for the Amiga. **RRP £229.95.**

**MIDI INTERFACE 2** Latest high quality product from Trilogic offering a total of FIVE MIDI sockets alleviating the need for lead swapping once connected to a MIDI system. **RRP £34.95.**

**MIDI LEAD** 1 metre lead allowing you to set up and get going! **RRP £4.99**

This total package would normally cost you over £269 but we are literally giving them away at the incredible price of:

**£99.95**

Music-X available separately at £79.95  
**HURRY - STOCKS LIMITED ON A FIRST COME FIRST SERVED BASIS!**

## AMIGA 1010 DISK-DRIVE SCOOP!

★ Original Commodore Disk drive  
★ Robust Design  
★ High quality & reliability  
★ Full Commodore 1 year guarantee

**OUR PRICE £59.95**  
**RRP £149.95**

## ★ ★ EXTRA SUMMER SEASON OFFER ★ ★

Above Amiga 1010 Drive Available with our 1/2 meg RAM expansion board (inc clock) **FOR ONLY £99.95**

## ★ 3 1/2" DISKS ★ 3 1/2" DISKS ★ 3 1/2" DISKS ★

All our disks are of the highest quality, are 100% certified and are individually wrapped. We guarantee each disk is either Sony, TDK or Verbatim unbranded.

50 .....	£26.99
100 .....	£49.99
200 .....	£89.99
400 .....	£169.99

## PERIPHERALS, ACCESSORIES AND SERIOUS SOFTWARE

FOR THE MORE DISCERNING COMPUTER USER	RRP	OUR PRICE
Commodore 1084S Stereo Monitor	£299.95	£249.95
Cumana 1.meg Quality Drive - The best	£89.99	£69.99
High Quality Amiga Dust Cover	£9.95	£5.95
High Quality 1084S Dust Cover	£12.95	£6.95
Replacement Amiga Power Supply	£59.95	£39.95
Kindwords 2 wordprocessor	£49.95	£29.95
Superbase Personal 2	£99.95	£29.95
Maxiplan Spreadsheet	£99.95	£29.95
Photon Paint 2 - Latest Version	£79.95	£29.95
Deluxe Paint 2 - Excellent Value	£49.95	£9.95
Aegis Sonix version 2	£69.99	£29.99

**ORDERING MADE EASY**



Order by phone by calling our Head Office quoting your Access/Visa Number



Order by Post - make Cheques, Building Society Drafts or Postal Orders payable to Dowling Computers

Add £6.00 courier delivery for all orders over £100.00 (UK mainland only). Add £2 for orders under £100.00





# HUNTING Tigers

The program is billed as the 'sequencer for the rest of us' which gives the impression that it is an entry-level program. And a correct impression it is too. However, rather like one of those Russian dolls, *Tiger Cub* has several different layers and is pretty intellectual when you dive into it. We now know why Dr T bundled MRS in with the Commodore Amiga package; *Tiger Cub* is the much improved and slightly more expensive replacement.

One appealing factor is that *Tiger Cub* can be self-sufficient and not rely on MIDI. You can, of course, hook up MIDI instruments to your heart's content, but at its most basic level the program will use internal voices, (up to sixteen in memory and the usual four simultaneously). At a pinch you can enter notes one by one on the editing screen. More of that later.

The program records and edits up to twelve tracks or instruments and, as an added bonus, you can view and print your finished efforts in standard music notation thanks to an additional software module called Quick Print. This is in fact a cut-down notation and scoring program. *Tiger Cub* is the sibling of a more detailed program called (surprise surprise) *Tiger*, which is a sort of acronym for The Interactive Graphic Editor.

The main screen. Nothing unfamiliar here and it is laid out very simply. The tracks, of which you can have up to 12, are displayed with all relevant information such as channel, instrument name and comments (good idea, this). Other columns tell you whether the track is muted, soloed, grouped together and indeed if it's playing at a particular moment – a flashing note serves this purpose.

Grouping tracks together means that at the flick of a button you can hear only the tracks you have chosen to hear, which is unusual for a budget package. One of its slight idiosyncrasies is that the MIDI channel displayed is actually the channel of the first note that has been input on that track. This is not exactly standard procedure and could prove to be confusing, especially if you have a track that has multiple channels of MIDI combined; this is another good reason for having the comments box.

## Confusion

The terminology for MIDI channels used in *Tiger Cub* is a little confusing but, once you get the hang of it, is pretty straightforward. As you may be aware, the usual process is to use one instrument to play in all the MIDI data. What channel it actually puts the sounds on is usually determined by the software, regardless of the channel it was played in on.

The filtered and re-channelled MIDI information is passed on simultaneously so that the chosen sound can

Got no MIDI gear at all, but thinking about it? **JON BATES** reckons it might be more than beneficial to take a look at *Tiger Cub*, the latest offering from the house of Dr T.

**RIGHT: The main screen of *Tiger Cub* with its neat and simple layout: tracks at the top and controls at the bottom.**

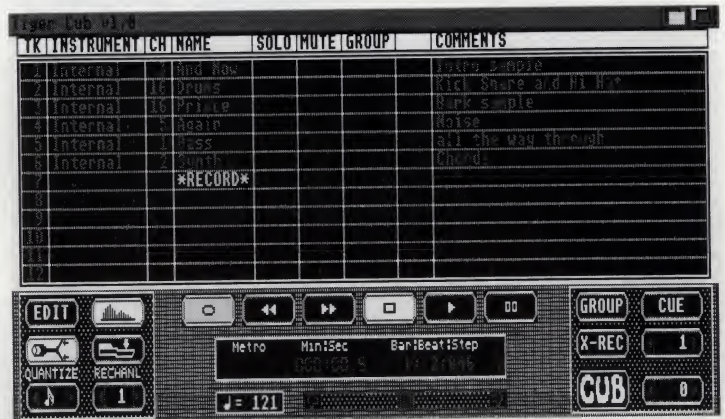

**BELOW: *Tiger's* Editing screen. The notes scroll across the grid from left to right.**

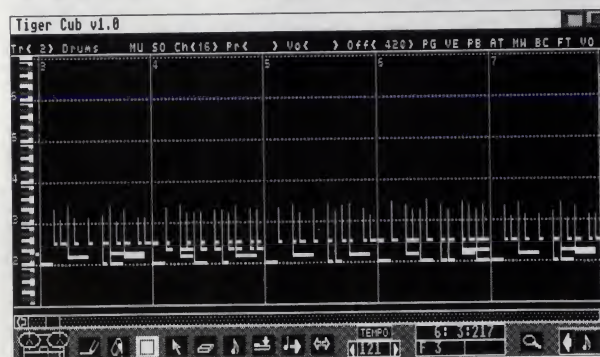

be played on whatever tone module. This process is nearly always done using a 'thru' switch and the channel alteration is done by the software. 'TC' has two, rather similar, icons.

There is a MIDI 'Merge' button which acts as a dumb 'thru' switch, passing on the incoming data to any other synths in the chain and recording it simultaneously without altering the incoming channel. The second button is a 'Rechannelization' feature. This passes the information on while recording it but allowing you to alter the MIDI channel. Why not just have one button that you can switch to an 'original channel' state?

I found myself having to read this section rather carefully in the manual as at one point it appeared that you couldn't change MIDI channels once they were recorded. In fact you can quite easily alter them from the editing screen, but not from the main screen, which is where the initial confusion arose.

## Features

Some features of Dr T's MRS sequencer are retained: you need to specify the length of track you are about to record (I hate this one!) and the 'record' logo jumps to the next available track automatically. A neat feature overcomes a short track length by continuing the recording on the next available track – I guess it's tough if you've run out of tracks.

Underneath the track listing is the main control panel decked out with the familiar tape transport icons, tempo slider and bar/time counter. The tempo range and number of steps allowed per beat – the overall quantization – are alterable from a friendly 'Environment menu' which, as we shall see, alters several other features as well.



The quantize button on this panel alters notes permanently as they are recorded and it is more than likely that you would prefer to fix things up after recording. Various icons act as filters for data like aftertouch and for controllers such as pitch bend, program changes and volume; usually these are not used too much and perhaps could have been left on a menu rather than on permanent display.

Should you mess up, the 'X-rec' button deletes the last track recorded. One of the several features I was surprised to find on a budget package like this was a cue button that will loop the track between specified bar numbers, which comes in handy for practising that solo.

### Editing

The editing is a big improvement on previous Dr T programs in that it uses a graphic 'piano roll' type of editor instead of a scrolling string of numbers. The notes themselves are presented in graphic form, scrolling (if auto scroll is on) from left to right across the upper part of the screen.

The display has a main track window and notes are displayed looking nearly like traditional notation with a stem going upwards but then a variable oblong shape streaming out from the base – the length of the oblong is proportional to the length of the note itself. An indication of pitch is given by the vertical piano keyboard along the left-hand edge of

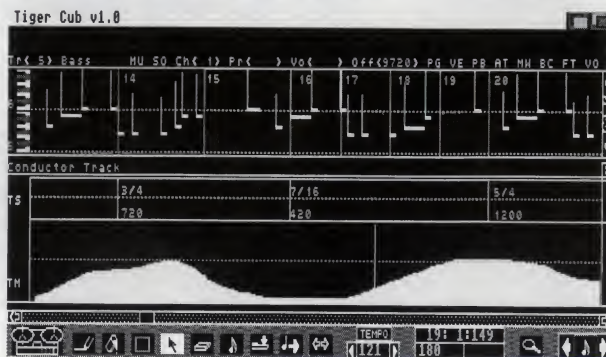
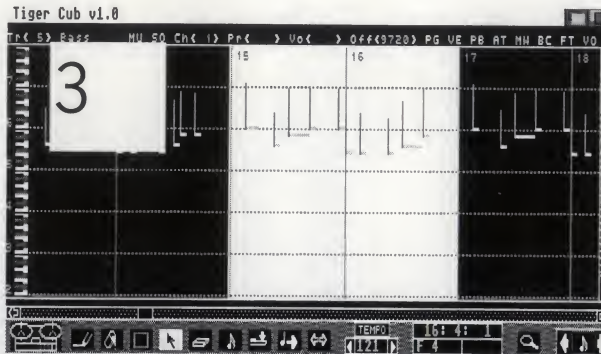

**TOP:** The white area is now ready to be manipulated, deleted or pasted elsewhere.

**ABOVE:** The Conductor track. By simply drawing shapes – the white areas – you alter the tempo! Note the figures above refer to complex changes in the time signature.

**BELOW:** The upper shaded 'mountains' are the graphic controllers, in this case set to control volume.

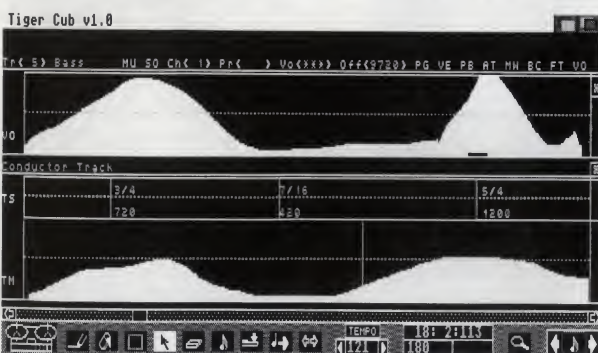

the screen which you can alter to come up with a rather odd colour combination of keys.

Editing can be achieved in several ways – you are not only editing the notes but also the controller data. The mouse is used for most editing functions but there are also options on the Edit menu and several qwerty keys are dedicated to specific editing operations. The simplest way to edit is to select an edit function from the set of button icons on the lower screen and zoom on an area or

particular note. As you do, relevant information concerning the note is displayed – the exact point within the sequence, pitch, velocity or, if a drum-kit file has been selected, the name of the drum.

Under the track window are the master controls for editing in icon form. These will draw notes, paste previously stored sections, select notes for editing, define what is called a 'horizontal range' – a section that can be moved – and of course each individual note can be altered in terms of pitch, velocity, length, and time, a separate icon toggling each function.

Notes can be dragged about either individually or in a group and deleted, cut and pasted in the same manner. As you may guess, the draw option lets you put notes wherever you want and you can hear them, if you want to, at the same time.

The initial velocity for each note is set in the Setting menu. The function keys come into play here as they will insert, delete, play staccato or legato and play what you have just written. Even more thoughtful is the option to assign certain MIDI controller numbers to these functions so that if you do have a MIDI keyboard you can perform the whole operation with leaving your seat. You can also record on the graphic page in the same way as on the main screen with only a few minor differences.

The real surprise with *Tiger Cub* is the graphic editing and drawing feature used on the control tracks. Before you reach for the Pseud's dictionary, all this means is that controls such as volume, pitch bend, modulation, stereo balance and a whole host of others can be controlled by drawing graphic shapes on the screen with the mouse.

There is also a track that enables you to control the tempo of the playback in much the same manner and also cope with very complex time changes. This is something that has only been introduced recently on rather up-market professional sequencing software and to find it on software selling for under £100 is rather incredible.

The control track runs underneath the notes window and you can work on several and, of course, edit them. It puts very professional touches within the budget of most of us. Other goodies that *Tiger Cub* sports are the drum kit files – these store the note numbers that correspond to the drums and of course you configure it to suit whatever drum module/machine you are using – when you are editing the drums on screen the name of the drum will pop up when you click on the note.

You can also store instrument files – these name the instrument that you are using and when you change the instrument in mid-track by using a program change number. The software looks at the instrument file and pops in the actual name of the sound. You can have up to six banks of instruments in a file and each bank is specified by the MIDI channel it uses. This will be very useful with instruments that have anonymous front panels and even more anonymous LCDs that display only numerals.

The finale to this round of up-market features is the scoring module. Though basic, it covers as much as you would expect from many packages with full score and single staff display, choice of clefs and drum track, specified ties, key signatures, quantization and joined stems.

Certainly more than enough for a quick hard copy reference and it has just enough edit menu facilities to massage any glitches out of the displayed result. It prints the results out via the standard Amiga printer driver but sadly it is permanently tied to *Tiger Cub* and will not work with other software. Sadly, the version that we had failed to load up the Quick Score module and crashed, but it must be remembered that review copies are first releases and the ones that reach the shop will be fixed.

*Tiger Cub* is an excellent entry-level program that is easy to get to know. It has features that are quite exceptional for its price and rather than complicating the program they actually make it much easier to work with. The accuracy and versatility of its recording and editing make it well worth the money even without its scoring and notation module. A very friendly and obedient Tiger that will make a fine family pet.

**All Amigas, Minimum 1 meg RAM ■  
£99.00 ■ MCM 01 256 3454**

**0742  
424230**



9am to 10pm

# STATE OF THE ART



9am to 10pm

**0742  
424230**

## Amiga A500

Every Amiga sold includes: WorkBench 1.3, extra disk, tutorial disk all with manuals, full one year warranty, mouse, free TV modulator and cables **£340 inc**

## Amiga Packs

**Batman.** Batman the Movie, New Zealand Story, F18 Interceptor and Deluxe Paint II **£355 inc**

## Flight of Fantasy

F29 Retaliator, Rainbow Islands, Deluxe Paint II, Escape From The Robot Monsters **£358 inc**

## 2nd Drives

Enable/Disable Switch Cumana CAX354 **£79 inc**

## Hard Drive

A590 20Mb HD with room for 2Mb of RAM **£365 inc**

## RAM Upgrade

0.5Mb Expansion enable/disable switch plus £5 for clock **£55 inc**

## 3.5" Unbranded Disks

**DD 100% Certified Labels & Postage**

52p each 10 to 50  
49p each 50 plus  
45p each 120 plus  
42p each 500 plus

5th Gear.....	£9.99
688 Attack Sub.....	£17.95
A.P.B.....	£10.99
Action Fighter.....	£17.95
Adidas Champ Football.....	£17.95
Airborne Ranger.....	£16.99
Altered Beast.....	£13.99
Antheads (Data Disk).....	£12.99
Aquanaut.....	£17.95
Baal.....	£9.99
Bad Company.....	£17.95
Balance Of Power 1990.....	£17.95
Barbarian 2 (Psygnosis).....	£16.99
Bards Tale.....	£8.99
Bards Tale 2.....	£17.95
Batman The Movie.....	£17.75
Black Tech.....	£14.99
Black Tiger.....	£17.75
Blasteroids.....	£7.99
Blood Money.....	£11.99
Bloodwych.....	£10.99
Bloodwych Data Disk.....	£9.99
Blue Angels.....	£17.75
Bomber.....	£21.75
Bomber (Data Disk).....	£13.99
Budokan.....	£17.95
Captain Blood.....	£4.99
Cartoon Capers.....	£15.99
Castermaster.....	£17.75
Chaos Strikes Back.....	£17.50
Chase HQ.....	£14.99
Chronoquest.....	£14.99
Cloud Kingdoms - Special Offer!!.....	£11.99
Colorado.....	£17.50
Conqueror.....	£17.75
Continental Circuit.....	£13.95
Crack Down.....	£16.99
Crazy Cars 2.....	£17.99
Cyberball.....	£14.49
Damocles.....	£17.25
Dan Dare 3.....	£14.25
Defenders Of The Earth.....	£9.99
Dragons Breath.....	£17.25
Dragons Lair (1Mb).....	£26.99
Dragons Of Flame.....	£17.95
Dungeon Master (1Mb).....	£16.99
E-Motion.....	£16.99
Escape From The Planet Of The Robot Monsters.....	£14.99
Escape Singes Castle.....	£28.99
F16-Combat Pilot.....	£17.75
F18-Interceptor.....	£17.25
F99-Retaliator.....	£17.25
Falcon.....	£19.99

Falcon Mission Disk.....	£14.99
Fiendish Freddy.....	£20.99
First Contact.....	£16.99
Future Wars.....	£17.95
Ghost Busters 2.....	£16.99
Gold Of Americas.....	£17.99
Gore.....	£17.99
Grand National.....	£16.99
Gravity.....	£17.75
Gunship.....	£17.75
Hammerfist.....	£17.75
Hard Drivin.....	£14.95
Heavy Metal.....	£17.75
Hero's Quest.....	£22.99
Hillsfar.....	£16.99
Hot Rod.....	£17.50
Imperium.....	£17.50
Infestation.....	£17.95
Interphase.....	£8.99
Iron Lord.....	£17.25
It Came From The Desert.....	£19.99
Ivanhoe.....	£17.25
Steel.....	£17.25
Jack Nicklaus.....	£10.99
Jack Nicklaus Courses.....	£10.99
Keep The Thief.....	£17.25
Kick Off.....	£11.99
Kick Off Extra Time.....	£9.25
Kick Off 2.....	£13.95
Kid Gloves - Special Offer!!.....	£11.99
Klax.....	£16.99
Knight Force.....	£17.75
Knights Of Crystallion.....	£21.99
Krysal.....	£13.99
Kult.....	£16.99
Laser Squad.....	£9.99
Last Ninja 2.....	£17.25
Liverpool.....	£16.25
Lords Of The Rising Sun.....	£17.95
Lord Dutchman's Mine.....	£17.99
Magnum 4.....	£22.95
Manchester Utd.....	£17.25
Micropose Soccer.....	£16.99
Midwinter.....	£17.99
Might And Magic 2.....	£21.99
Millennium 2.2.....	£11.99
Moonwalker.....	£17.99
Ninja Spirit.....	£17.95
Ninja Warrior.....	£16.99
North and South.....	£17.25
Nuclear War.....	£17.25
Operation Thunderbolt.....	£17.75
P47 Thunderbolt.....	£17.25
Pinball Magic.....	£17.50
Pipemania.....	£17.95

Pirates.....	£17.25
Pools Of Radiance.....	£17.99
Powerdrift.....	£11.99
Projectyle.....	£17.25
Rainbow Islands.....	£16.99
Reach For The Stars.....	£17.25
Resolution 101.....	£17.50
Return To Atlantis.....	£17.50
Risk.....	£14.75
Robocop.....	£17.50
Rocket Ranger.....	£16.95
Roger Rabbit.....	£8.99
RVF Honda.....	£16.99
Seven Gates Of Jambala.....	£10.99
Shadow Of The Beast.....	£22.50
Shadow Warriors.....	£17.25
Sim City.....	£21.25
Sim City Editor.....	£11.99
Space Ace.....	£28.95
Space Rouge.....	£20.99
Speedball.....	£16.99
Star Trek V.....	£24.99
Steele.....	£9.99
Strider.....	£17.95
Stunt Car Racer.....	£17.25
Super Cars.....	£15.99
Switch Blade.....	£14.99
Swords Of Twilight.....	£17.50
Test Drive 2.....	£17.25
TD2-Supercars.....	£10.99
TD2-Musclecars.....	£10.99
TD2-California.....	£10.99
The Cycles.....	£17.50
The Lost Patrol.....	£17.50
Their Finest Hour.....	£21.99
Theme Park Mystery.....	£17.25
Third Courier.....	£17.50
Time & Magic.....	£10.99
Tower Of Babel.....	£17.95
Triad 2.....	£13.99
Triad 3.....	£21.99
Turbo Outrun.....	£17.25
TV Sports Basketball.....	£19.99
TV Sports Football.....	£17.99
Ultima V.....	£19.99
Ultima VI.....	£22.95
UMS 1.....	£17.25
UMS 2.....	£17.50
Untouchables.....	£17.50
Vindicators.....	£9.99
Warhead.....	£17.25
Wipeout.....	£15.99
World Cup Soccer 90.....	£17.25
X-Out.....	£15.99
Xenomorph.....	£17.50

## Joysticks & Other Bits

Multi Coloured Cruiser.....	£10.99
Quickjoy III Supercharger.....	£11.99
Quickjoy Superboard.....	£15.99
Competition Pro Extra-Clear.....	£12.95
Star LC10 Printer.....	£159.99
Star LC10 Colour Printer.....	£201.25
Superpic Genlock & Dgitizer.....	£469.99
TV+Text Professional.....	£89.99
TV+Show 2 The Best Ever!.....	£59.99
Video Titler.....	£74.99

## State Of The Art

has someone to answer your call from 9am to 10pm. Ring now for the best service around.

We run an Amiga Club. To join just give us a ring and even better prices will be yours on all hardware and software.

Unreleased titles will be sent within 24hrs of release date.

Access or Visa cards are accepted.

TO ORDER SEND POSTAL ORDER OR CHEQUE TO:  
**FREEPOST  
STATE OF THE ART  
25 NORWOOD AVE  
SHEFFIELD  
S5 0QH**

## THE AMIGA MUSIC MATRIX

**A disk magazine for the Amiga Musician.**

Issue One has Sampled Sounds from the Korg M1 in IFF Format 8 Trak Soundtracker Software. Articles and tutorials on MIDI, Music and using Amiga Basic for music playing/teaching.

Issue One is available now price £10 or you may subscribe for four issues for only £35.

Issue Two - phone for details

New Release - Amiga Music PD list on disk from the Matrix £2.00.

Phone for further details 0592 714887 or write to:



**THE MUSIC MATRIX  
14 MAIN STREET,  
EAST WEMYSS KY1 4RU**

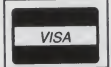

## COMPUTERWISE

BRIGHTON

(0273) 674626

FAX (0273) 684383

**AMIGA A500 £369.00**

INC VAT

Workbench 1.3, Extras 1.3, the very first English version, four software titles, all leads and modulator, included with the above. Please add £12.00 for next day courier delivery. We have 100s of software titles in stock at all times, as well as books and peripherals. Up to £1000 instant credit for personal callers. Full written details on request. We are your Amiga specialists, so phone or call in today for all your Amiga needs

Open 10 am to 5.30pm Monday to Saturday  
**44 George Street, Kempdown, Brighton**  
George Street is opposite the American Express building.

VISA



FROM THE CREATORS OF  
**STOS MAESTRO**

## TECHNOSOUND AMIGA STEREO SOUND SAMPLER

MIX YOUR VERY OWN CHARTBUSTERS

PLUG IN STEREO CARTRIDGE  
TOP QUALITY SOFTWARE

- \* 1 TO 35 KHZ SAMPLE RATE
- \* TRUE AND SIMULATED STEREO
- \* REAL TIME EFFECTS
- \* COMPREHENSIVE EDITING CAPABILITY
- \* EXTENSIVE LOOPING FACILITIES
- \* SAMPLING BY MUSICAL NOTE OR FREQUENCY
- \* STUNNING STUDIO STYLE EFFECTS
- ECHO-REVERB-HALL-ROOM-PHASER

PLUS **FREE** AUDIO TUTORIAL CASSETTE

NEW DIMENSIONS

BROOKLANDS HOUSE  
BRYNGWYN RAGLAN  
GWENT NP5 2AA  
0291-690933/690901

ONLY **£29-99**  
+ £1-50 POST AND PACKING

Although we had a quick look at this program in Issue 11 I thought that, since *Tiger Cub* does simplified scoring, another quick glance at this budget scoring package might be appropriate. They are compatible, which is not surprising since *Copyist* will accept a variety of files including MIDI files, SMUS and files created by Dr T's own sequencing software.

The program works on two levels. It will function as a stand-alone music typewriter, where you put each note and symbol in individually, and it will also work as a transcription program accepting all the various files mentioned above.

In general the program has as complete a range of music signs and symbols as you could ever wish for. Although you can use the menus to enter each symbol and sign, it is in fact far quicker to use the qwerty keyboard as every action is duplicated by the keys. The keys that you use are

And we've just time for a quick look at more scoring: *Copyist...*



# Copyist APPRENTICE

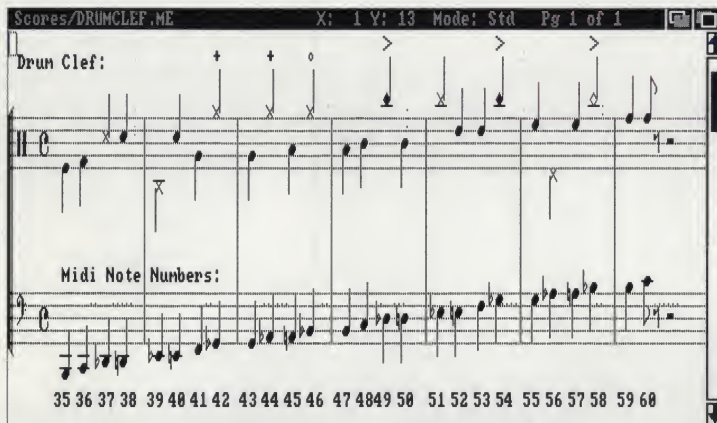

LEFT: *Copyist* supports drum notation...

fairly instinctive, usually taking the first letter of the symbol.

This is probably a legacy from its first incarnation which was for the IBM PC. It has a problem, in that when you choose the medium resolution you can see everything quite clearly but you can't see more than three staves at a time; although you can scroll up and down the page. Put it into hi-res and the screen flickers and the staves are very squashed up making them unintelligible. Other factors against *Copyist Apprentice* are that it is rather slow in operation and overall the display is rather spidery and thin.

Having looked on the black side, *Copyist Apprentice* is certainly full of everything to score programs out with - all notes, bars brackets, clefs, expression marks, text with a wide choice of typefaces, and absolutely tons of help all over the place - you can even load in score pages that give you on-screen help concerning the ranges of orchestral instruments.

It has dedicated drum score pages and can cope with guitar chords. I think that the problem is that you need to take time to learn all the commands. Dr T include templates to stick over the keyboard to make life a

little easier in this respect. Just like any good text processor you can cut out and paste any part of the score, flip from page to page, and also insert sections.

As a transcription service it is definitely much improved. You convert your original file to a Stream file, the special format the *Copyist* requires. There is a whole page of options which you have to complete concerning the appearance of your music: how the notes are to be displayed with stems and beams, what quantization should be used on the notes, how many bars per line and staves per page, should rests be included, is a split point required if it is a piano track and so on.

Having done this, it is not too arduous a task to go through the transcribed file and add expression and phrase marks and whatever else you need, since *Copyist* has everything on hand. This is a much faster and more rewarding way to work and is probably the best use that the program can be put to.

I think that although *Copyist Apprentice* has lots of good features it tends to fall down on speed and display, these being slow and

scrawny respectively. It would have been nice to not only print out fill scores but also to be able to select individual parts as well.

However it is, at the moment, a very cost effective and comprehensive package if you can take your time to get round it. *Copyist* runs with a wide variety of printers including Inkjets and laser printers and the final appearance should be rather better than the screen display. There is a Professional version of *Copyist* which will set you back just under £300 with greatly enhanced features and details. At just under £80 there is no competition that comes anywhere near this software.

...as well as plain staves (BELOW) and even those odd guitar chords (BOTTOM).

All Amigas, Minimum 1 meg RAM ■  
£79.95 ■ MCM 01 256 3454

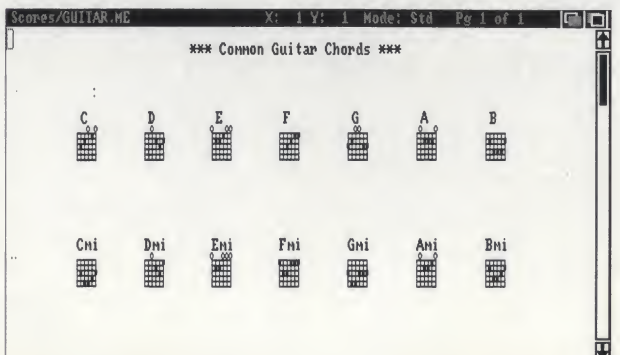
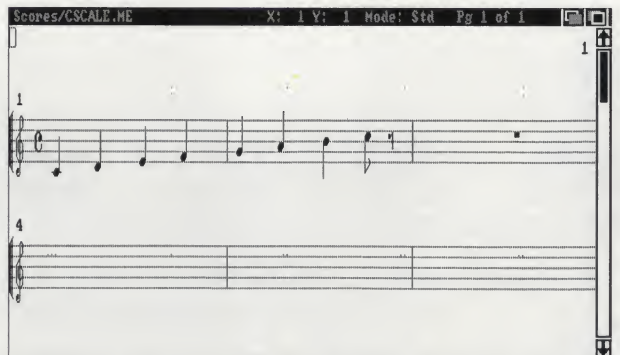

# ROTOX

**ROTOX** – The man was a trooper in the elite marines, injured on combat duty. **ROTOX** – The Cyborg has been transformed by 22nd century science into a devastating computer, assisted fighting machine.

**ROTOX** – The game features a revolutionary technique called **ROTOSCAPE** which allows the whole landscape to revolve around you providing a 360° nightmare environment of deadly machines and hostile life forms. **ROTOX** – a revolutionary new experience!

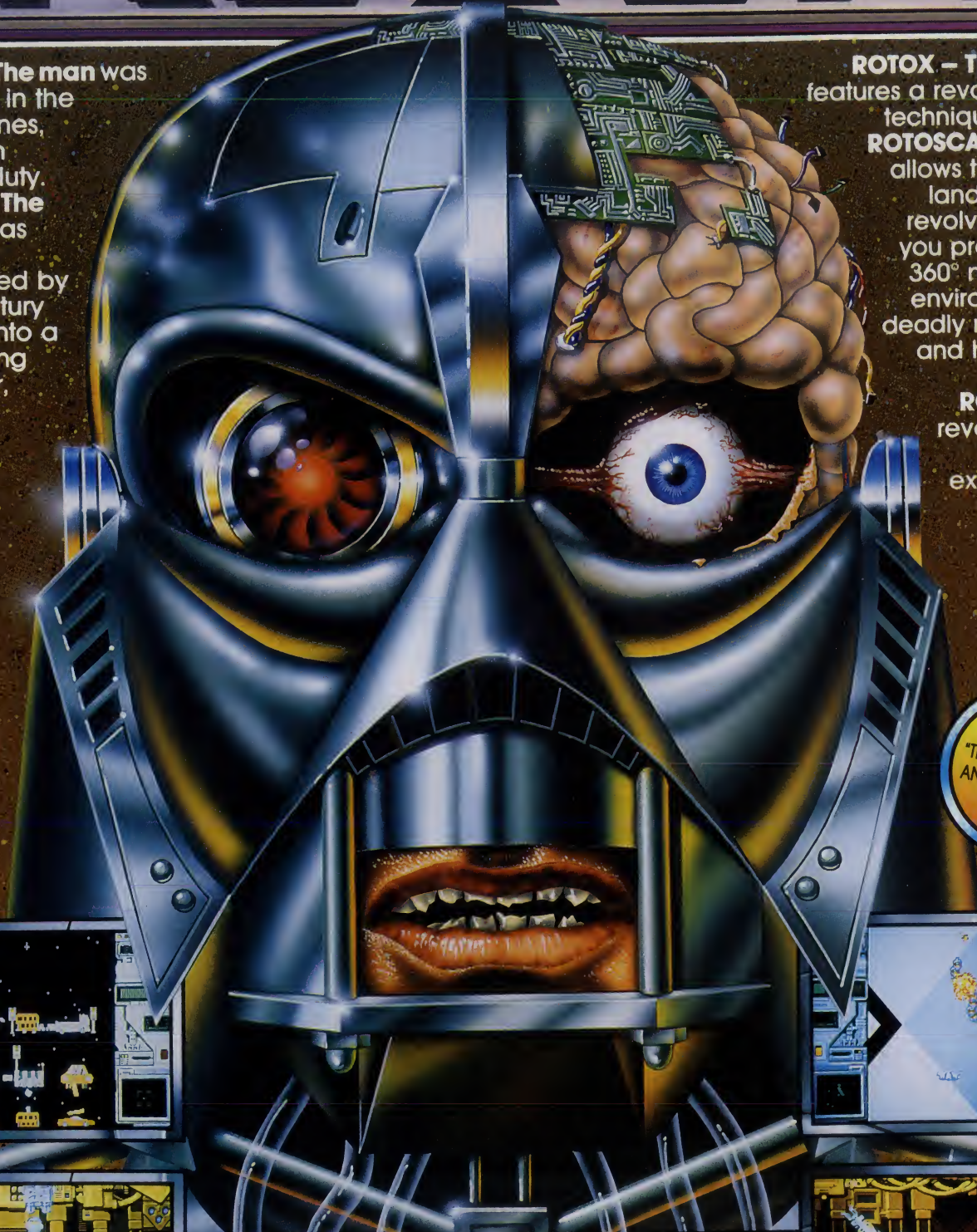

INCLUDES  
"THE ROTOX FILES"  
AND **FREE** ROTOX  
STICKER!

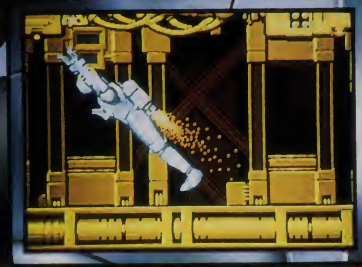
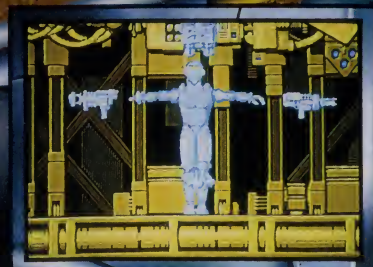

**YOU SAY YOU WANT  
A REVOLUTION –  
THIS IS IT!**

Screen shots from 16 bit formats.



**IBM PC & COMPATIBLES  
ATARI ST • AMIGA**

U.S. Gold Ltd., Units 2/3 Holford Way, Holford, Nottinghamshire, NG12 5AY, Tel. 001 495 2288

ROTOX © 1990 U.S. Gold Ltd./Creative Materials Ltd. All rights reserved. 203050495 © 1990 Creative Materials Ltd. All rights reserved.

# 1

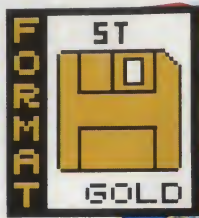

## Rainbow Islands from Ocean

This follow up to Bubble Bobbie looks set to be as much of a hit as Ocean's last cutesy game, New Zealand Story. It combines colourful visuals with frighteningly addictive gameplay, with the result that you end up with one hell of a game.

Graphics have been downloaded from the original arcade version and the moves are just the same. Lead Bub and Bob to the top levels by firing rainbows into the air and then climbing them. When you reach the top of a platform, you can collect thousands of bonus points. There are seven islands to complete, each one more challenging than the last.

"Graftgold's ST Version of Rainbow Islands is one of the best coin-op conversions to have appeared in along time" Maff Evans, ST Format



### Rainbow Islands

		PRICE	CODE
Amstrad CPC	Cass	£ 9.99	BF832AC
Amstrad CPC	Disk	£14.99	BF833AD
Commodore 64	Cass	£ 9.99	BF834CC
Commodore 128	Disk	£14.99	BF835CD
Spectrum 48K	Cass	£ 9.99	BF836SC
Spectrum +3	Disk	£14.99	BF837SD
Atari ST	Disk	£19.99	BF838ST
Amiga	Disk	£24.99	BF839AM

# THE BIG

An **INCREDIBLE** way to buy the month's top titles!

# BUY ONE - GET

## BIG FOUR MAIL ORDER

- Fast delivery
- Friendly service
- Fabulous savings

We're backed by the resources of one of Britain's most successful publishers so you can order with confidence.

## It's so simple!

You may find it hard to believe that we're GIVING away software but it's true. You simply buy any of the titles on this page at the normal retail price listed and then you can pick any other title (or the same title on a different format) absolutely free of charge!

The only condition is that the value of the free game must not be greater than that of the game you're paying for.

Apart from that there are no strings attached. It's literally TWO for the price of one! Or FOUR for the price of two...the sky's the limit! Have you ever seen a better offer...?

**FIRST CLASS POST, PACKING & VAT, INCLUDED**

# 3

## Fiendish Freddy's Big Top of Fun from Mindscape

Mindscape's circus extravaganza brings you thrills, spills and a whole barrel o' laughs. Dive from high-boards, walk tightropes, be fired from cannons, swing on trapezes, throw knives and juggle in a desperate bid to save the circus from the big bad bank. An original multi-event game with a wicked sense of humour!

### Fiendish Freddy

		PRICE	CODE
Amstrad CPC	Cass	£ 9.99	BF847AC
Amstrad CPC	Disk	£14.99	BF848AD
Commodore 64	Cass	£ 9.99	BF849CC
Commodore 128	Disk	£14.99	BF850CD
Spectrum 48K	Cass	£ 9.99	BF851SC
Spectrum 128	Disk	£14.99	BF852SD
Atari ST	Disk	£24.99	BF853ST
Amiga	Disk	£24.99	BF854AM

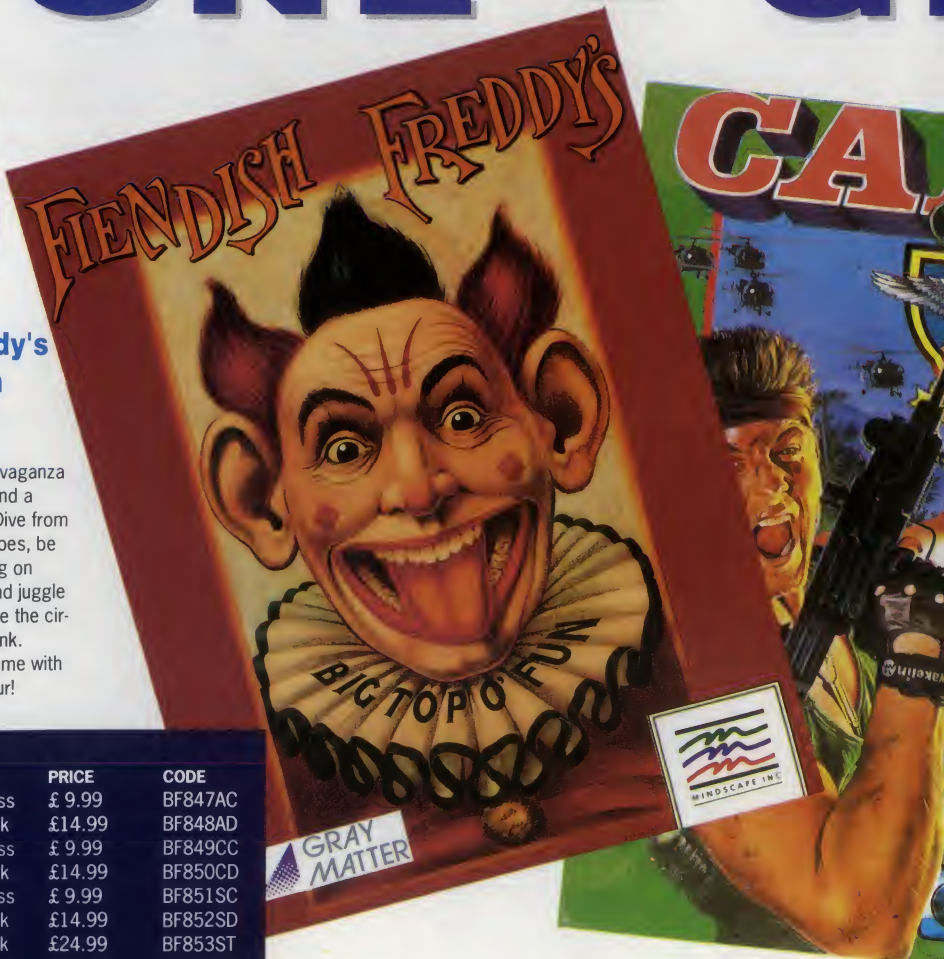

# G

# 2

## Black Tiger from U S Gold

US Gold have had major hits with Strider and Ghouls 'n' Ghosts. Now comes their latest horizontally-scrolling action game, Black Tiger. In a similar fashion to Ghouls, the objective is to charge through horizontally-scrolling levels, climbing ladders and following red arrows to the end of the level. Along the way, fight ugly gargoyles, snakes and even deadly orchids using your powerful weaponry. When the going gets tough, disappear inside the shop, pick up some extra weapons, and go out for another merry blast. If you're a fan of horizontally-scrolling action games, you'll love this one.



### Black Tiger

		PRICE	CODE
Amstrad CPC	Cass	£ 9.99	BF840AC
Amstrad CPC	Disk	£14.99	BF841AD
Commodore 64	Cass	£ 9.99	BF842CC
Commodore 128	Disk	£14.99	BF843CD
Spectrum 48	Cass	£ 9.99	BF844SC
Atari ST	Disk	£19.99	BF845ST
Amiga	Disk	£24.99	BF846AM

# GET ONE FREE!



# 4

## Cabal from Ocean

Go crazy in cartoonland with Cabal. A lone trooper, he's dropped behind enemy lines and must fight his way back home. Level after level must be cleared of buildings and bad guys with machine guns, grenades and bazookas. It looks like Operation Wolf for the under fives but plays like a vet.

### Cabal

		PRICE	CODE
Amstrad CPC	Cass	£9.99	BF855AC
Amstrad CPC	Disk	£14.99	BF856AD
Commodore 64	Cass	£9.99	BF857CC
Commodore	Disk	£14.99	BF858CD
Spectrum 48K	Cass	£9.99	BF859SC
Spectrum +3	Disk	£14.99	BF860SD
Atari ST	Disk	£19.99	BF861ST
Amiga	Disk	£24.99	BF862AM

## ORDER HOTLINE 0458 74011

Post to: Big Four Mail Order, The Old Barn, Somerton, Somerset TA11 7PY

**YES**, I want to take advantage of this remarkable way of buying software.

The game(s) I would like to BUY are:

Title	Machine	Order Code	Price

The game(s) I would like FREE are: (You may claim one free title for each game bought. The total price of the free game(s) must not be greater than the total price of the paid-for game(s).)

Title	Machine	Order Code	Price
			<b>FREE!</b>
			<b>FREE!</b>

NAME \_\_\_\_\_

ADDRESS \_\_\_\_\_  
 \_\_\_\_\_  
 \_\_\_\_\_

POST CODE \_\_\_\_\_

PAYMENT BY:  Cheque  Access  Visa

CREDIT CARD NUMBER \_\_\_\_\_  
 \_\_\_\_\_

EXPIRY DATE \_\_\_\_\_

Please make cheques payable to "Big Four Mail Order".

# UNREAL

“Best arcade game on Amiga” GEN 4

ENTER THE MAGICAL WORLD OF UNREAL  
AND OVERCOME THE ALL POWERFUL  
MASTER OF DARKNESS!



FIVE different types of INTERACTIVE MUSIC along with incredible sound effects, such as the rushing waters of a river, the crackling of fire...



“A completely INTERACTIVE environment: feel free to run and jump up and down hills, but be careful not to slip on the snow and ice or be blown off a cliff by the wind!



Stunning TWO and THREE DIMENSIONAL graphics. A VARIETY of monsters, dragons and bizarre enemies with their own strategies and different weapons.



Disponible dans les FNAC et dans les meilleurs points de vente

**UBI SOFT**

8-10, rue de Valmy  
93100 MONTREUIL SOUS BOIS  
Tél. (1) 48 57 65 62



# Pump UP THE MUSIC

Designing games is far from an easy task, as any programmer will tell you. With the arrival of AMOS this exciting world is no longer unreachable, even for those who wouldn't know the difference between a bitplane and a microwave oven. But once you've got your graphically wonderful spaceships flying smoothly around dealing laser death to colourful aliens, how do you add that extra exciting element? Simple. You give the game a stirring soundtrack.

Various tools are available for creating music for games and demos, many of them in the Public Domain. Unfortunately, most of these systems are either overly simplified or require a great deal of knowledge on the programming side of things. German programmers Chris Hulsbeck and Peter Thierolf have developed a way of creating game music that manages to avoid both these traps, in the shape of TFMX Soundtool.

TFMX is a completely integrated music programming tool that allows you to build a complete masterpiece from patterns using various samples. Your tune can then be saved out and played independently of the program using the TFMX player. Thus you can have a piece of music playing behind your demo or game, or just as a background to a program, by simply calling the file up from your listing.

### Back to Life

What you actually get is the TFMX disk which contains various versions of the editor (for machines with different memory configurations), the music player and a set of demo tunes, a comprehensive manual and a protection dongle which plugs into the joystick port.

Loading up the disk gives you a rather nice demo tune showing what the program is capable of producing, complete with atmospheric, breathy samples and snatches of Soul II Soul's "Back to Life".

Once you have got past this and loaded up the editor you are presented with TFMX's main track screen. All the functions are carried out either by clicking on buttons or by entering values at the cursor. This saves the need for any complicated portrayal of scales and staves for those with little musical experience.

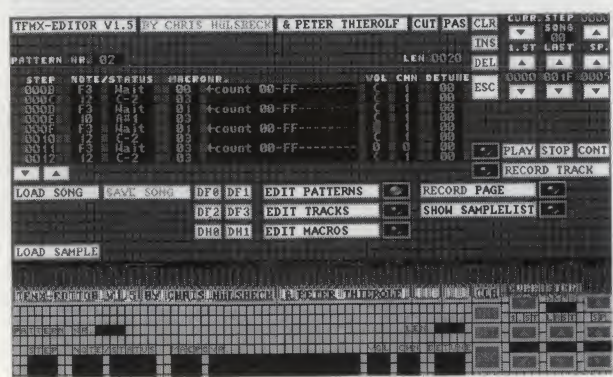

**RIGHT: The main track compiling screen. This where you can patch the patterns together to form a complete song**

**BELOW: This shows the Pattern Editor. The note values simply trigger beats, while the WAIT commands set when they are to be played**

In the world of games, one thing that has benefited from the power of the Amiga is the music. **MAFF EVANS** looks at a new tool to help games designers to add soundtracks to their creations.

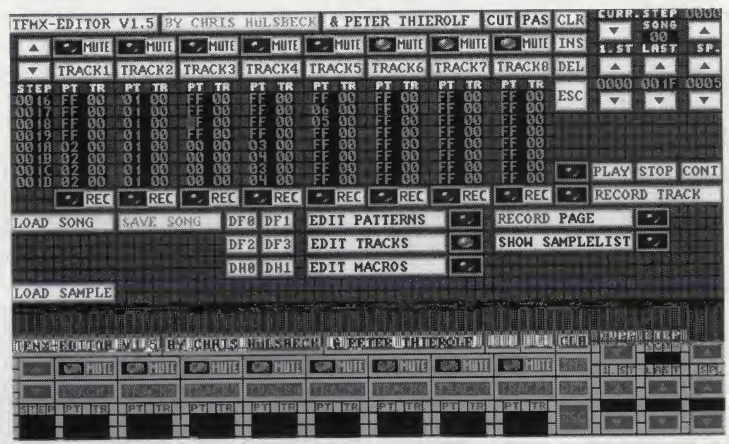

The manual gives a step by step introduction into the workings of the program using a tutorial piece, to allow you to get to grips with the feel of the pattern and track editors.

As long as you follow the tutorial and don't try to run before you can walk, the system is fairly simple to use. Simply load up a sample from the LOAD SAMPLE page, assign it to a macro and you can start writing your tune. This is done by building up a pattern and then using the patterns to construct a complete song on the track editor.

### MacroComputing

One of TFMX's main strengths is the power you have over the use of samples. Once you have loaded up a sample, you can create a macro to hold the sound's information - such as

start location, sample length, and whether to play it as a one-shot sample or as a loop.

More complex manipulations can also be carried out, such as vibrato, portamento and envelope shaping. The more adventurous can even tell the macro to jump into another sample and then return to the original. This can provide some strange sounds, including a very impressive, spasmodic 'cut-up' effect on vocal samples (a technique I'm particularly keen on).

Even if your original sample doesn't fit into the required format (for example your beautiful choir sample is off key and gets cut off by an orchestra blast) you can assign detune values to get the key perfect and set cut-off values so that the sample will finish playing rather than

# TFMX

## MUSIC REVIEW

being cancelled out by the next note. This amount of flexibility is unsurpassed, even in high-end Amiga sequencing packages, and gives an unbelievable amount of freedom in using sounds.

### Jigsaw Music

Now that you've got your samples loaded and the macros set up, it's time to do some music-writing.

Flicking into the pattern editor presents you with a window displaying all the commands in the selected pattern. Sequences are built up by entering a hex value to designate a note, along with the sample macro number (which sets which sound the pattern will play), the output channel to use (so that sounds stay separate) and the note volume.

Following each note, a command must be entered to set when the next note is played (either a delay, or wait for the current sample to end) or to decide when to end the sequence. The patterns are of a variable length – although if the pattern is short it must have a STOP command set at the end, so that the sequencer doesn't get confused and stop the other patterns from playing – and can contain any number of macros – you can even have different sounds playing on the same beat by leaving out the pause between them.

Once you've created your pattern, you can put it into the song on the TRACK EDIT page. To play a pattern, all you do is type in the number of the pattern you wish to be played on the step line you wish it to appear, much in the same way that a drum machine builds up songs.

Eight tracks are available, which rather than playing on eight channels (which would be a surprising feat, since the Amiga only has four), allows you to place eight patterns on each step. However this doesn't mean that eight patterns choc-a-block with notes will all play together; you can still only play four notes on one beat! The track page also allows you to set the speed and the starting and stopping positions of the track.

### Just for the Record

On this page you can also set up a pattern ready for recording. All you do is put a clear pattern on one of the tracks and click on that track's record icon. An 'LED' will illuminate to tell you it's ready. Now you can go to the track page and set up the 'count in' and metronome speeds.

Hit the RECORD button and press Caps Lock to put the sequencer in

**RIGHT: All samples have to be assigned with macros, which hold all information on speed, tuning, volume and looping**

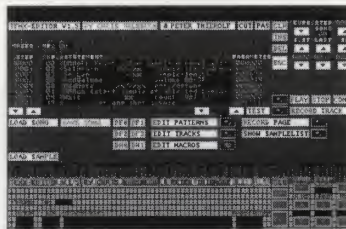

**RIGHT: The Record Page is where the settings for realtime pattern recording are determined, from record speed to metronome rate**

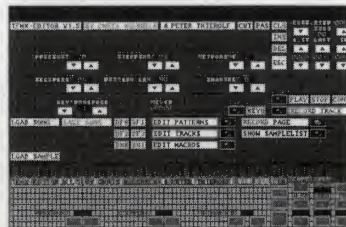

**BELOW: TFMX can be run with a four-colour editor, freeing valuable memory for samples and song program data**

**BOTTOM: A whole list of samples can be loaded in most formats, from basic RAW data to ready-structured IFF files**

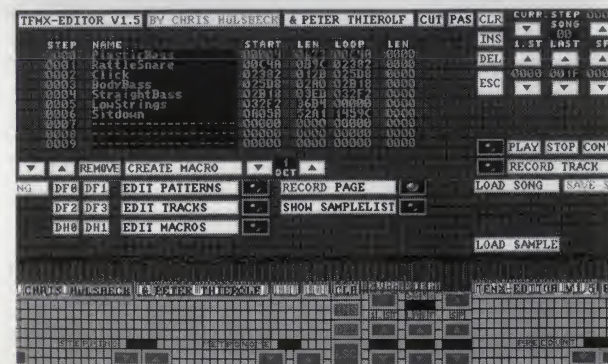
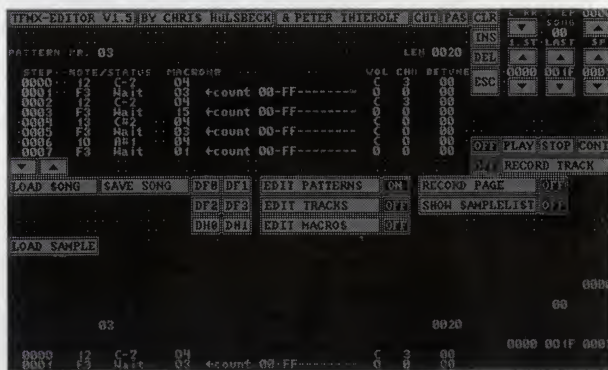

'test' mode. Hammer away at the keyboard to rehearse your part and press the Caps Lock key when you're ready. Now play your piece and hit the left mouse button to finish. Now you can go to the pattern editor to correct your mistakes (mistakes? It's that 'human' feel, guv'nor!) The 'record' feature allows those who have no confidence in remembering the relevant values of notes to get tuneful pieces into patterns without bashing through a laborious 'trial and error' process.

### All in the Game

So you've set up your samples, programmed the patterns and constructed a song. All that's left is to stick it into your game.

Once you've saved out your song, all you have to do is simply copy the TFMX player into the C: directory of the disk containing your program, and enter the command to call up the tune via the player in your listing. You can compile a number of

tunes in one file, and call up the relevant song from within the file.

This means that you can have a start-up tune, an end-of-level tune and a 'game over' tune all in one file to save disk space and still call them up individually. You can also define how the tune will end, either by pressing the left mouse button or the escape key, or by a separate command (after all, you don't want to have to press the escape key at the end of each game, do you?). TFMX will run easily from all popular languages, including BASIC programs, C listings and even machine code, so you can incorporate music with relative ease.

### Let's get down to it, Boppers!

TFMX Soundtool is the most comprehensive and powerful game music creator yet to appear on the Amiga. The sheer flexibility of sound use and the ease of pattern programming completely overshadows similar programs, including the now well-established Game Music Creator and even Sound Tracker.

There are a couple of quirks, however, such as the annoying habit that TFMX has of hanging up when you attempt to record on a pattern that hasn't been cleared. The record feature starts up okay, but press the mouse button to stop recording, and an error message flashes up to tell you that the pattern is clear. Press the mouse button to continue and what happens? The record feature starts up again. Press the mouse to stop and you get the message again... argh!

To be fair, the manual carefully outlines how to go about each feature, so mistakes are at a minimum, and helps to explain each feature simply, but with enough detail so that you can get to grips with all the program's functions. Having said this, a great deal of thought has to be applied to achieve decent results, and creating tunes should not be taken lightly by occasional dabblers. TFMX is described as a programming tool, and as such is superb at its job.

Chris and Peter promise further enhanced versions of the program due this winter for around £100, including such delights as built-in sampling and MIDI features. This could put TFMX well out of the reach of competitors for some while!

If you write games or demos and want to add music, but can't face the thought of grappling with the Amiga's sound chip directly, get hold of TFMX and you won't be sorry!

### TFMX SOUNDTOOL

All Amigas ■ £44.95 ■

Demonware/Software Business,  
Brooklands, New Road, St. Ives,  
Huntingdon, Cambs PE17 4BG.

Tel. 0480 496497

# BYTEBACK

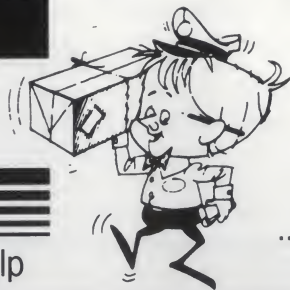

## FAST DELIVERY SERVICE

...and the keenest prices

Ring us now! **0636-79097** we're programmed to help

FIND OUT WHY MOST AMIGA USERS PREFER BYTEBACK!

GAMES ONLY!	COMPILATIONS ONLY!	ART ONLY!	PUBLIC DOMAIN
All Dogs go to Heaven .....18.90 Bomber.....19.90 Boxing Manager.....13.90	<b>ALL TIME FAVOURITES.....19.90</b> Test Drive, Hard Ball, Mean 18+ Famous Course disk (vol. 1 and 2) <b>WORLD CUP 90.....16.90</b> Kick Off, International Soccer, Track Suit Manager. <b>AMERICAN DREAMS.....15.90</b> Super Ski, Bubble Ghost, Operation Neptune, Hostages <b>RENAISSANCE.....13.90</b> Invaders, Megapede, Draxians, Rockstorm	TV Text.....52.50 TV Show (NEW).....69.90 Deluxe Paint 2.....19.90 Deluxe Print 2.....34.90 <b>DELUXE PAINT 3.....59.90</b> Deluxe PhotoLab.....49.90 Design 3D.....59.90 Director (The).....42.90 <b>DIGIVIEW GOLD (v.4).....129.90</b> Fantavision.....29.90 Pixmate.....37.90 <b>GRAPHICS STARTER KIT.....34.99</b> Aegis Animator/Images Aegis Draw + Artpak. 1 plus Arazoks Tomb - Graphic Adventure!	<b>1 Disk = £3.00 4 disks = £9.90</b> <b>10 disks + file box = £19.90</b> This is just a selection from our Public Domain Library Ask for our new JULY catalogue <b>AU.01</b> Jazzbench: Superb Workbench replacement; fully multitasking! <b>AU.03</b> QL Emulator - plus 2 disks full of programs (3 Disks - £6.90) <b>AG.01</b> Star Trek 1 - Version of the ST adventure game (3 Disks - £6.90) <b>AG.02</b> Pacman, Gravity wars, Hanoi Jackland, Othello, Empire, etc. <b>AG.03</b> Star Trek 2 - (Agatron) Superb strategy game, see May issue of Amiga Format! (2 Disks - £4.90) <b>AD.01</b> Walker demo 1, animation of Star Wars Walker (need 1MB) <b>AG.04</b> Monopoly; classic board game! <b>AG.05</b> Pacman 87; Multi level game. <b>AG.06</b> Cosmoroids, Amoeba, Stone Age, Backgammon, Chain Reaction, Yahtzee, Daleks, Blackjack, Klondike... etc <b>AG.10</b> Space Invaders + Lunar Lander!
<b>SALE ★ SALE ★ SALE ★ SALE ★</b> Battle Squadron .....9.90 Blood Money .....9.90 Bloodwych .....9.90 Bloodwych DATA DISK .....7.90 Kid Gloves.....9.90 Chessmaster 2000.....9.90 Colossus Chess X.....9.90 Pacmania.....9.90 Shadow of the Beast.....18.90 Escape From Singes Castle.....18.90 MUSIC X.....99.90	<b>THRILL TIME (8 GAMES!).....16.90</b> Buggy Boy, Live & Let Die, Space Harrier, Thundercats, Battleships, Ikari Warriors, Beyond the Ice Palace, Bombjack <b>MILESTONES.....13.90</b> Spherical, Grand Monster Slam, Circus Attractions, Hard 'n' Heavy <b>STAR WARS TRILOGY.....18.90</b> Star Wars, Empire Strikes Back, Return of the Jedi <b>HIT DISKS (Vol.1).....9.90</b> Goldrunner, Karate Kid II, Jupiter Probe, Slaygon <b>HIT DISKS (Vol. 2).....9.90</b> Major Motion, Time Bandit, Leatherneck, Tanglewood	Professional Draw.....109.90 X-Cad Designer.....89.90 <b>UTILITIES ONLY!</b> AmigaDOS Toolbox.....39.95 BBC Emulator.....39.90 Cashbook controller.....54.90 Devpac 2.....44.90 DigiCalc.....29.90 <b>PUBLISHERS CHOICE.....79.90</b> Page Setter, Kind Words 2, Artists Choice + Fonts Home Accounts.....22.90 Logo.....42.90 Pagesetter (2).....69.90 Pen Pal.....99.90 Personal Tax Planner.....29.90 <b>X-COPY 2 (+ hardware).....34.90</b> The BEST Backup utility!	<b>AG.13</b> Adventure game solutions - Over 100 including; Sierra, Infocom, Rainbird, Ultima, Dungeon Master Future Wars (2 disks: £4.90) <b>AW.03</b> Icons; 100's including the amusing Naughty Icons, Ram icons, Music Icons.. plus icon utilities. <b>AD.04</b> Probe Sequence; simulation of video pictures from an interstellar probe landing on an alien planet! <b>AD.18</b> Puggs in Space; extremely funny animation of alien creature landing on Earth and exploring... <b>AC.02</b> Pagesetter Art; 100's of professional quality clip art pics <b>AS.01</b> Samantha Fox; 12 high quality digitised pictures! <b>AS.04</b> Playboy 1; 16 digitised pics
<b>FREE - ONE PUBLIC DOMAIN DISK WITH EVERY TWO GAMES ORDERED!</b> Pick from PD list opposite!	<b>KINGS QUEST TRIPLE PACK.....24.90</b> Kings Quest I, II & III <b>PRECIOUS METAL.....18.90</b> Xenon, Capt. Blood, Crazy Cars, Arkanoid II <b>CHILDRENS ONLY!</b> AB Zoo (Alphabet tutor).....9.50 Fun School 2 (Under 6).....13.90 Fun School 2 (6 to 8).....13.90 Fun School 2 (Over 8).....13.90 Three Little Pigs.....19.90 Three Bears.....19.90 The Ugly Duckling.....19.90 Postman Pat.....8.90 Micro English (GCSE).....18.90 Micro Maths (GCSE).....18.90 Micro French (GCSE).....18.90 <b>DISKS (DS/DD 3.5") ONLY!</b> Bulk - 100% Guaranteed! 10 = 7.90 50 = 34.90 100 = 64.90 SONY Boxed - 100% Guaranteed! 10 = 12.90 50 = 59.90 100 = 99.90 <b>BOOKS (Abacus) ONLY!</b> Amiga for Beginners.....12.90 Amiga Basic Inside and Out.....18.90 Machine Language.....14.90 Tricks and Tips.....14.90 More Tricks and Tips.....14.90 System programs.....32.90 Amiga DOS Inside and Out.....18.90 Disk Drives Inside and Out.....27.90 Disks for above books.....13.90 ROM Kernal manual.....28.90 Hardware Reference manual.....19.90	<b>MUSIC ONLY!</b> Deluxe Music Con. Set.....49.90 Instant Music.....18.90 Mastersound.....29.90 <b>MUSIC - X.....99.90</b> Pro Sound Designer.....59.90 <b>ACCESSORIES ONLY!</b> Locking Disk Box (40+).....7.90 Locking Disk Box (80+).....9.90 Media Box (150 - stackable).....22.90 <b>FURRY MOUSE COVER!.....6.90</b> (with eyes, ears and nose!) Mouse Mat.....5.90 Keyboard or Monitor Cover.....5.90 Printer Stand.....9.90 Naksha Mouse.....34.90 Optical Mouse (superb!).....34.90 Midi Master.....34.90	<b>AW.04</b> Probe Sequence; simulation of video pictures from an interstellar probe landing on an alien planet! <b>AD.18</b> Puggs in Space; extremely funny animation of alien creature landing on Earth and exploring... <b>AC.02</b> Pagesetter Art; 100's of professional quality clip art pics <b>AS.01</b> Samantha Fox; 12 high quality digitised pictures! <b>AS.04</b> Playboy 1; 16 digitised pics Plus - Fred Fish, TBAG, APDC. <b>JOYSTICKS ONLY!</b> Joystick & Mouse extension.....4.90 Joystick lead - 3 metres!.....4.90 Quickshot Deluxe.....9.90 Quickjoy II Turbo.....9.90 Quickjoy III Supercharger.....9.90 Quickjoy Jetfighter.....12.90 Cruiser (CLEAR).....13.90 Competition Pro Extra.....15.90 Arcade Joystick.....16.90 <b>HARDWARE ONLY!</b> AMIGA A500.....359.90 Philips CM8833 monitor.....259.00 512K RAM expansion.....59.90 Cumana 3.5" Disk Drive.....99.00 Senator 3.5" Disk Drive.....89.00 Mono Video Camera + lens.....229.90 Bootselector.....14.90 Hardware Virus protector.....19.90 Nordic Action Cartridge.....69.90
Dragons Breath.....18.90 Drakken.....18.90 Dyter 07.....13.90 Emlyn Hughes Int. Soccer.....15.90 Escape From Robot Monsters.....15.90 Fire and Brimstone.....15.90 F-29 Retaliator.....17.90	<b>HIT DISKS (Vol.1).....9.90</b> Goldrunner, Karate Kid II, Jupiter Probe, Slaygon <b>HIT DISKS (Vol. 2).....9.90</b> Major Motion, Time Bandit, Leatherneck, Tanglewood	AmigaDOS Toolbox.....39.95 BBC Emulator.....39.90 Cashbook controller.....54.90 Devpac 2.....44.90 DigiCalc.....29.90	<b>AW.03</b> Icons; 100's including the amusing Naughty Icons, Ram icons, Music Icons.. plus icon utilities. <b>AD.04</b> Probe Sequence; simulation of video pictures from an interstellar probe landing on an alien planet! <b>AD.18</b> Puggs in Space; extremely funny animation of alien creature landing on Earth and exploring... <b>AC.02</b> Pagesetter Art; 100's of professional quality clip art pics <b>AS.01</b> Samantha Fox; 12 high quality digitised pictures! <b>AS.04</b> Playboy 1; 16 digitised pics
Hardball 2.....17.90 Heroes Quest.....24.90 Kick Off 2.....15.90 Klax.....15.90 Knights of Crystallion.....18.90 Leisure Suit Larry 3.....29.90 Lost Patrol.....18.90 Manhunter San Francisco.....21.90 Midwinter.....16.90	<b>DISKS (DS/DD 3.5") ONLY!</b> Bulk - 100% Guaranteed! 10 = 7.90 50 = 34.90 100 = 64.90 SONY Boxed - 100% Guaranteed! 10 = 12.90 50 = 59.90 100 = 99.90 <b>BOOKS (Abacus) ONLY!</b> Amiga for Beginners.....12.90 Amiga Basic Inside and Out.....18.90 Machine Language.....14.90 Tricks and Tips.....14.90 More Tricks and Tips.....14.90 System programs.....32.90 Amiga DOS Inside and Out.....18.90 Disk Drives Inside and Out.....27.90 Disks for above books.....13.90 ROM Kernal manual.....28.90 Hardware Reference manual.....19.90	Professional Page (1.3).....179.90 Scribble Platinum.....42.90 Virus Killer.....9.90 Workbench 1.3.....14.90 Works Platinum.....119.90	<b>AW.03</b> Icons; 100's including the amusing Naughty Icons, Ram icons, Music Icons.. plus icon utilities. <b>AD.04</b> Probe Sequence; simulation of video pictures from an interstellar probe landing on an alien planet! <b>AD.18</b> Puggs in Space; extremely funny animation of alien creature landing on Earth and exploring... <b>AC.02</b> Pagesetter Art; 100's of professional quality clip art pics <b>AS.01</b> Samantha Fox; 12 high quality digitised pictures! <b>AS.04</b> Playboy 1; 16 digitised pics
Deluxe Strip Poker.....9.90 Centrefold Squares.....9.90 Romantic Encounters.....9.90	<b>DISKS (DS/DD 3.5") ONLY!</b> Bulk - 100% Guaranteed! 10 = 7.90 50 = 34.90 100 = 64.90 SONY Boxed - 100% Guaranteed! 10 = 12.90 50 = 59.90 100 = 99.90 <b>BOOKS (Abacus) ONLY!</b> Amiga for Beginners.....12.90 Amiga Basic Inside and Out.....18.90 Machine Language.....14.90 Tricks and Tips.....14.90 More Tricks and Tips.....14.90 System programs.....32.90 Amiga DOS Inside and Out.....18.90 Disk Drives Inside and Out.....27.90 Disks for above books.....13.90 ROM Kernal manual.....28.90 Hardware Reference manual.....19.90	Deluxe Music Con. Set.....49.90 Instant Music.....18.90 Mastersound.....29.90	<b>AW.03</b> Icons; 100's including the amusing Naughty Icons, Ram icons, Music Icons.. plus icon utilities. <b>AD.04</b> Probe Sequence; simulation of video pictures from an interstellar probe landing on an alien planet! <b>AD.18</b> Puggs in Space; extremely funny animation of alien creature landing on Earth and exploring... <b>AC.02</b> Pagesetter Art; 100's of professional quality clip art pics <b>AS.01</b> Samantha Fox; 12 high quality digitised pictures! <b>AS.04</b> Playboy 1; 16 digitised pics
Pipe Mania.....18.90 Player Manager.....13.90 Projectile.....18.90 Red Storm Rising.....17.90 Resolution 101.....16.90 Sim City.....18.90 Scrabble Deluxe.....15.90 Shadow Warriors.....18.90 Skidz.....15.90 Space Quest III.....24.90 Teenage Mutant Ninja.....22.90 Their Finest Hour.....22.90 Theme Park Mystery.....18.90 Time Soldiers.....18.90 Treasure Trap.....15.90 Turrican.....15.90 Ultimate Golf.....18.90 Warhead.....18.90 World Cup Soccer.....15.90 688 Attack Sub.....18.90	<b>DISKS (DS/DD 3.5") ONLY!</b> Bulk - 100% Guaranteed! 10 = 7.90 50 = 34.90 100 = 64.90 SONY Boxed - 100% Guaranteed! 10 = 12.90 50 = 59.90 100 = 99.90 <b>BOOKS (Abacus) ONLY!</b> Amiga for Beginners.....12.90 Amiga Basic Inside and Out.....18.90 Machine Language.....14.90 Tricks and Tips.....14.90 More Tricks and Tips.....14.90 System programs.....32.90 Amiga DOS Inside and Out.....18.90 Disk Drives Inside and Out.....27.90 Disks for above books.....13.90 ROM Kernal manual.....28.90 Hardware Reference manual.....19.90	Pro Sound Designer.....59.90	<b>AW.03</b> Icons; 100's including the amusing Naughty Icons, Ram icons, Music Icons.. plus icon utilities. <b>AD.04</b> Probe Sequence; simulation of video pictures from an interstellar probe landing on an alien planet! <b>AD.18</b> Puggs in Space; extremely funny animation of alien creature landing on Earth and exploring... <b>AC.02</b> Pagesetter Art; 100's of professional quality clip art pics <b>AS.01</b> Samantha Fox; 12 high quality digitised pictures! <b>AS.04</b> Playboy 1; 16 digitised pics

All prices include VAT and FIRST CLASS POST!  
GUARANTEED RETURNS OF POST DELIVERY ON ALL STOCK ITEMS!

# BYTEBACK

DEPT AF, 6 MUMBY CLOSE, NEWARK, NOTTS NG24 1JE

Cheque, postal orders or credit card facilities are available



# NUMBER ONE AMIGA CLUB

## ATTENTION ALL AMIGA OWNERS, READ THIS!

We are so confident of our services and prices, that if for any reason you are not satisfied within 30 days of joining we will refund your membership money.

Join the Number One Amiga club today, and you can save hundreds of pounds off recommended retail prices. Super fast delivery, call free hotline, special membership pack, instant refunds, and of course the very best prices. Only £5 for one year membership, no commitments! Join now, we promise you will not be dissatisfied.

Direct from West-Germany the N° 1 branded selling disk on the market 'Edixa' Top top quality, and every Edixa disk carries our lifetime warranty.

We can offer to all members these branded disks at unbeatable prices.

Price per box 10

3.5 inch DS/DD 1meg .....£ 6.99

3.5 inch DS/HD 2meg .....£15.99

### ACCESSORIES

	MEMBERS	RRP
A2300 Genlock A2000	£219.99	269.99
Minigen A500 Genlock	£94.99	129.99
Vidi Amiga/Vidi Chrome	£99.99	129.95
Mid Interface A500/1000/2000	£24.99	39.99
Boot selector - Boot from DF1	£8.99	19.99
Electronic Boot Selector - DF0-DF3	£24.99	39.99
Fat Agnus 8327A	£54.99	89.99

### PROFESSIONAL SOFTWARE

	members	rrp
ATalk 3 Communications	£49.99	69.99
Deluxe Paint 3 Graphics	£59.99	79.99
Deluxe Video 3 3D Animation	£79.99	129.99
Director Desktop Video	£39.99	69.99
Home Accounts Financial	£24.99	39.99
Lattice V5.0 Prog Language	£169.99	229.95
Pagesetter V2.0 DTP	£59.99	79.99
Pen Pal Wordprocessor	£79.99	129.95
Scribble Platinum	£44.99	79.95
Word Perfect V4.0	£119.99	179.95
X-Cad Designer CAD CAM	£79.99	113.95

## SPECIAL OFFERS

**Music X** The professional state of art music package.  
Normal RRP ..... £229.95 Members price ..... **£109.95** incl. VAT

**Digiview 4.0** The latest version, pal compatible, unbeatable price.  
Normal RRP ..... £149.99 Members price ..... **£99.99** incl. VAT

**Deluxe Paint 2** The classic graphics program, at a price never to be repeated!  
Normal RRP ..... £49.99 Members price ..... **£14.99** incl. VAT

**Photo Paint 2** Superb animation graphics at an affordable price.  
Normal RRP ..... £89.95 Members price ..... **£39.99** incl. VAT

**X-Copy 2.10** The Number One backup program. Copies up to 4 disks in 48 seconds. Format disks in only 36 seconds. Includes super fast text editor and cv parameter.  
Normal RRP ..... £39.99 Membersprice (Hardware+software) ..... **£29.99** incl. VAT  
Software only ..... **£19.99** incl. VAT

**Kikstart Card** For Amiga 500/2000, original ROM 1.2 or 1.3 easy to fit, no soldering!  
Normal RRP ..... £49.99 Members price ..... **£14.99** incl. VAT

### RAM EXPANSIONS

Made in West-Germany. The Number One best selling ram expansions. Exclusively imported. Quality and quality again at fantastic prices. 12 month warranty.

**A500 512K RAM CARD** + battery backed clock + On/Off switch. Uses low power 1 Meg Dram.  
Normal RRP ..... £79.99 Members Price ..... **£49.99** incl. VAT

**A500/1000 2 MBYTE RAM CARD** External, low power auto configure Incl. Ramtest Disk  
Normal RRP ..... £169.95 Members Price ..... **£289.95** incl. VAT

**A2000 8 MBYTE RAM CARD** Lower power auto, internal with 2MByte RAM.  
Normal RRP ..... £499 Members Price ..... **£299.99** incl. VAT

### TOP AMIGA GAMES all prices include VAT

	members	rrp		members	rrp
688 attack sub	16.95	29.95	Leisure Suit Larry 2	21.95	34.99
Battle Chess	15.95	24.95	Leisure Suit Larry 3	22.95	34.99
Bomber	18.95	39.99	Manhunter 2	17.99	29.95
Battle of Britain	16.49	24.99	Midwinter	17.99	29.95
Bridge Player 2150	18.45	29.99	M1 Tank Platoon	27.95	39.99
Budokan	15.95	24.99	Mavis Beacon Typing	17.45	29.99
Chase HQ	15.99	34.99	Ninja Warriors	15.95	24.99
Chess Player 2150	15.95	24.95	Player Manager	11.99	19.95
Chess Champion 2175	17.95	24.99	Police Quest 2	19.49	34.95
Cyberball	12.95	19.99	Populous	15.95	24.95
Colossus Chess X	14.99	24.99	Pro Tennis Tour	15.95	24.99
Die Hard	15.95	24.99	Pipemania	15.99	24.99
Dragons Lair 1	26.99	44.99	Rainbow Island	15.45	24.95
Dragon Lair 2	27.99	49.95	Rotox	16.99	24.99
Double Dragon 2	15.95	24.99	Shadow of Beast	14.99	24.99
Ferari Formula 1	15.95	24.99	Space Quest 2	19.99	34.95
F16 Combat Pilot	15.95	24.99	Space Quest 3	19.99	34.99
F29 Retaliator	15.49	24.95	Starflight 2	15.95	24.95
F16 Falcon	17.95	29.99	Test Drive 2	15.95	24.99
Flight Simulator 2	19.95	29.95	Tower Babel	15.49	24.99
Future Wars	15.95	24.95	Triad Comp Vol 3	18.99	29.99
Grand Prix Circuit	15.95	24.99	Turbo Outrun	15.99	24.95
Italia 1990	15.95	24.95	Ultima 5	17.45	29.95
Kick off	11.99	19.99	Untouchables	15.99	24.95
Kings Quest 1, 2, 3	20.95	34.99	Warhead	15.49	24.95
Kings Quest 4	20.95	34.99	Windwalker	16.95	29.95

### PRICE BUSTERS

B.C. Football	6.95	Lord Rising Sun	8.99
Baal	6.45	Millenium 2.2	6.49
Ballistix	6.45	N. Mansel Grand Prix	5.49
Battle Squadron	10.99	Purple Saturn Day	6.49
Chessmaster 2000	7.99	Sky Chase	6.99
Chronoquest	8.99	Starglider	5.99
Conflict Europe	5.99	Terrorpods	7.99
Empire Strikes Back	6.99	The 7 cities Gold	8.99
Extra Time	6.99	The Kristal	11.99
Football Manager 2	10.49	Triad 2	11.99
Kick Off	11.99	TV Sports Football	11.49
Live let Die	5.99	UMS Military Sim	6.99
Lombard Rac Rally	8.99	Xenon 2	6.49

### DELIVERY CHARGES

Software:  
UK £1.00 EEC £2.00  
C. Service hardware:  
UK £5.00 EEC £10.00  
Normal delivery 1-4 working days.

All prices and supplies subject to change without notification.  
Trading division of Nortek Computers Ltd.

CALL FREE  
0800-898219



Send to: Number One Amiga Club,  
Trafalgar House, Grenville Place, Mill Hill, NW7 3SA

QUANTITY	DESCRIPTION	PRICE
	DELIVERY	
	MEMBERSHIP	
	TOTAL	

I enclose cheque/PO for £ \_\_\_\_\_ inc VAT  
or charge my Access/Visa No: \_\_\_\_\_

Exp. Date \_\_\_\_\_

\_\_\_\_\_

Name \_\_\_\_\_

Signature \_\_\_\_\_

Address \_\_\_\_\_

Postcode \_\_\_\_\_

Tel. No \_\_\_\_\_



In days long past, when 8-bits ruled the earth, the two languages in common use were BASIC and assembler. Even these split into many varied dialects, but BASIC was far the most popular. For better or worse, those days have gone.

The arrival of the Amiga has seen a new generation of languages sneaked into the home environment, some of which were previously unseen outside universities or scientific institutes, most of which were unable to run without the sheer processing muscle of yesterday's mainframes. Even familiar titles like BASIC have silently undergone a complete revamp to rival more accepted languages in terms of power, complexity and performance.

### Scale of the Problem

The problem, if it is a problem, was and still is this: most home computer programmers are unfamiliar with doing anything on a large scale. Previously the vast majority of home computers were limited in terms of memory size and general complexity.

Few people outside industry or research institutes had any idea what multitasking was; let alone how to program in such an environment. Their minds were very firmly fixed with the idea of one computer, one job. Even the chosen few had only dabbled with simple interrupts afforded by processors like the 6502 and Z80. Now they were faced with a computer capable of handling many tasks at once without so much as blinking.

For many, the very idea of an operating system interfacing between them and the hardware was alien. Many had come from machines like the Spectrum where the operating system was just a part of the BASIC ROM.

Even those familiar with the idea of a separate operating system – ROM based or not – were flummoxed by the sheer size of the Amiga's. At 256K it was 16 times the size of the one employed by the once all-powerful Acorn BBC Micro. And WIMP interfaces? The whole suggestion of point, shoot, and let the computer get on with it was almost obscene.

### Mind Your Language

When faced with a machine as complex and comprehensive as the Amiga one question is nearly always raised: "Do you use high-level or low-level languages?" This is an area where the user is spoilt for choice.

At the lowest level, the machine features a set of very complex custom chips which MUST be treated with respect. A programming bug here will not cause the machine to catch fire – as used to be rumoured with an ancient Commodore micro – but it can cause subtle bugs.

Moreover, subtle bugs can occur on seemingly identical machines – more than one game has come to grief

# MIND YOUR Language



Illustration: Sally Gaden

There are so many programming languages around, that it's hard to know which is the one for you. **MARK SMIDDY** sorts it all out.

by working fine on 90% of Amigas but failing on the other 10%. This problem is further expounded by the ever expanding variety and configurations of machines available. Not only in terms of memory, but extra and faster processors, new system ROMs just around the corner with a completely new version of intuition and a revised set of custom chips.

At higher level, when programming applications, for instance, there are even more things to consider. Not least, all good Amiga applications should be capable of interacting cor-

rectly with the rest of the machine. At the very least this means "hitting the metal" (directly accessing the hardware) – a common practice on 8-bits – is right out.

Moreover, a correctly written Amiga program MUST be able to co-exist with anything else that happens to be running in the machine. This has some major implications for the programmer. Not only must he consider the need of his own programs but also correctly arbitrate for use of any hardware (or virtual hardware, like screens) the program may require.

# THE AMIGA 500 PC/XT IS HERE

## AMIGA 500

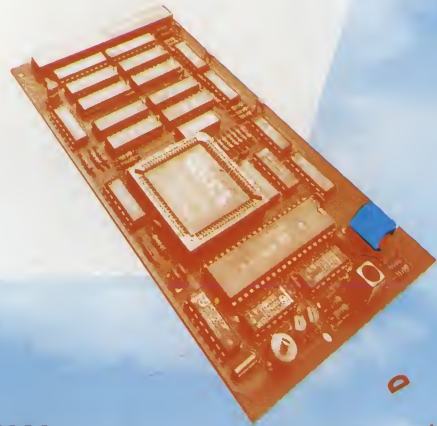

**RUN PROFESSIONAL  
MS DOS SOFTWARE  
ON YOUR AMIGA 500  
AT A PRICE YOU CAN AFFORD**

# POWER PC BOARD

## WHY DID YOU BUY AN AMIGA 500?

Of course, because of its superb graphics, music and animation capabilities. However if you want to get serious, you soon realise that it is distinctly lacking in memory and professional software.

### Well - They Said It Could Never Happen - But It's Here At Last!

You! In your own home can transform your Amiga 500 into a real IBM compatible **PLUS** up to **ONE AND A HALF MEGABYTE** Amiga memory expansion.

It's simple - No screwdriver, no soldering iron and no technical knowledge required. Just turn your Amiga over, open the cover, slide the Power PC Board into the connector, close the cover and your Amiga PC/XT is ready. (In other words, no loss of guarantee)

You are now ready to use a wealth of professional MS DOS software at speeds faster than a PC/XT (ind. review), **and in colour**, with compatibility thanks to Phoenix-Bios.

You can also rely on the correct date and time at any moment in Amiga and MS DOS mode (with the aid of a battery).

- ★ Video support: monochrome, Hercules and Colour Graphics Adaptor (CGA) (4 and 8 colours)
- ★ Disk support: internal 3.5" external 3.5" external 5 1/4" drive. (Software-upgrade to H/D A590 in pipeline)
- ★ Including MS DOS 4.01, MS DOS shell and GW Basic (market value approx £130.00)
- ★ Including English Microsoft books + KCS manual + FREE software
- ★ Further exciting software upgrades in the pipeline

- ★ Available memory: 704KB + 64KB EMS in MS DOS mode, 1 megabyte + 512KB RAM (disk) buffer in Amiga mode
  - ★ No extra power supply necessary thanks to the most modern CMOS and ASIC technology
  - ★ OK with TV. No special monitor required
  - ★ Price: **£320.00 including VAT.**  
**Access and Visa accepted.**
  - ★ For export price please contact us
  - ★ Trade enquiries welcome (UK - Scandinavia - Australia/NZ and all English language.)
- First deliveries expected imminently. Place your order now and get into the queue. Don't send any money yet. We will contact you when we are ready to ship.

*Compatibility is excellent, but no-one can guarantee every single program available therefore if your purchase depends on a particular program, please ask us first or send in a copy of the program. (With suitable S.A.E if to be returned). Price subject to change without notice.*

# BDL

## BITCON DEVICES LTD.

88 BEWICK ROAD, GATESHEAD,  
TYNE & WEAR, NE8 1RS ENGLAND.

Tel: (091) 4901919/4901975.

Fax: (091) 4901918

BASIC has become synonymous with home computing and, despite the efforts of many computer professionals, has managed to gain a foothold and a huge following that simply won't go away. It was intended as a gentle introduction to programming; indeed, the acronym BASIC means Beginners All-purpose Symbolic Instruction Code, but of course you already knew that.

The idea of BASIC is to remove the complexities of conventional computer programming by providing an environment devoid of almost any form or structure; which is, according to experts, where it falls down.

This is, of course, the very feature which has endeared it to so many over the years. It is friendly, easy to learn, simple to program and invariably simple to debug. BASIC listings tend to be easy to read and understand. Also, the extensive error checking provided by most interpreters (later, compilers) mean it is the language least likely to crash the machine.

For the reasons outlined here, the Amiga is very well served with versions of BASIC varying in quality from the sublime to the downright appalling. There are so many BASICs there isn't room to fit them all in here; this is a selection of the more common ones.

PROGRAMMING LANGUAGES

BASICS

## AMIGA BASIC

Free with the Amiga

Fits, regrettably, into the latter category – appalling. Regrettably because it is the one supplied with the machine and, therefore, many people's first impression of programming the machine. It has a slightly chequered history; suffice to say the version on release at the moment is based on the industry-standard Microsoft BASIC. For "industry standard", read easily convertible but crude.

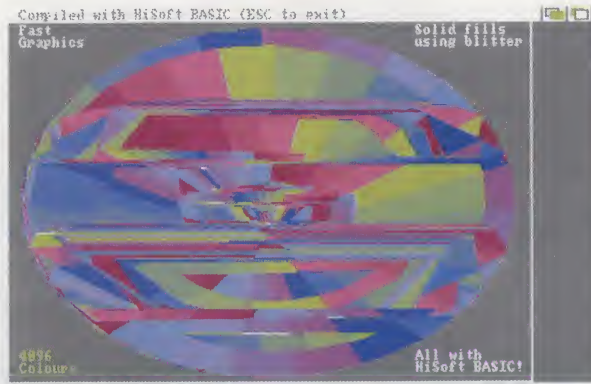

For openers, the authors have chosen to use Intuition's GIMMEZEROZERO windows. This bit of Amiga mumbo-jumbo means in effect the cartesian (geometric) 0,0 co-ordinate starts at the top right-hand corner of each window's drawing area. Normally, programmers have to correct for this in software. Since Intuition does this automatically, the net result leaves window updates VERY slow.

Next up, AmigaBASIC lacks any form of decent file request. The poor beginner is left instead to cope with a simple Intuition string gadget. Taking nothing away from Intuition, this would be fine – apart from the fact that it leaves beginners floundering with the complexities of AmigaDOS.

As a final nail in AmigaBASIC's pine overcoat (with optional silk trimmings and polished brass accompaniment) it is slow – very slow. True, by comparison to other interpreted BASICs it is reasonably fast – but in terms of pure performance it makes the Amiga – in every other way, a very powerful machine – seem tedious.

**TOP: This nice HiSoft BASIC demo came to grief when subjected to the editor!**

**ABOVE: Even this AmigaBASIC demo looks paltry when you consider the machine's potential.**



**LEFT: Oops! This lissajous figure in True BASIC looked great on my screen!**



**True BASIC**  
Addison-Wesley, Price N/A

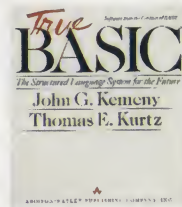

Comes from Kemeny and Kurtz – the inventors of BASIC, no less. After they had seen their language called every rude name possible and criticised for lacking structure (even though real structured programming was not "in" when BASIC was created) they sat down and redefined the language to bring it more up to date.

The result of this effort is True BASIC, and a very nice job it is too. While it retains the feeling of the BASIC language and remains easy to learn, it is capable enough to produce large applications and still easy to learn. True BASIC is compiler-based which means syntactic buggettes – like typing errors – are caught long before the program is run properly. The same is true of all compilers here, incidentally: this is not a unique feature of True BASIC.

True BASIC is supplied in typical Addison-Wesley style – on two disks with two voluminous manuals, all packed in a giant box. One manual explains True BASIC Amiga in depth, the other is a reference guide. Both use a large font which is kind to the myopic. Kemeny and Kurtz call it "The Structured Language System for the Future." How true this is in practise remains to be seen – but judging from documentation alone, it is the logical progression from those first BASICs.

**HiSoft BASIC**  
HiSoft,  
Compiler £79.95  
Extend £19.95



Comes as some salvation to AmigaBASIC users because it is largely compatible with it, also borrowing some features from Microsoft's PC Quick BASIC. The main difference is HiSoft BASIC is compiled, resulting in

# DISCOUNT SOFTWARE

For The Commodore Amiga

## WORD PROCESSING

Kind Words 2 .....£35.95  
 Protex See "Specials".....£64.95  
 Protex Working Demo Disc...£5.00  
 Scribble Platinum.....£41.95

## SPREADSHEETS/FINANCIAL

DG Calc by Digita.....£26.95  
 K-Spread 2 by Kuma .....£49.95  
 Home Accounts by Digita ..£20.95  
 Personal Tax Planner Digita...£26.95

## DATABASES

Mailshot (label printing) .....£18.95  
 K-Data .....£32.95  
 Prodata see "Specials".....£59.95

## BUSINESS SOFTWARE

System 3.....£35.95  
*Invoicing, Stock Control and Cashflow Control*  
 Cashbook Controller.....£35.95  
 Final Accounts.....£21.95  
*Adds End of Year accounts to  
 Cashbook Controller*  
 Cashbook Combo.....£54.95  
*both Cashbook Controller and Final Accounts*

## GRAPHICS & VIDEO

Pagesetter 2.....£75.95  
 Deluxe Paint III .....£59.95  
 Deluxe Video III.....£59.95  
 ZVP Video Studio.....£89.95  
 Rendale 8802 Genlock.....£189.95  
 Digiview Gold v4.....£119.95  
 Digidroid.....£64.95

## A.M.O.S.

MJC PRICE £34.95

## SOUND

Mastersound budget sampler.....£34.95  
 Trilogic Stereo Audio Digitiser  
*software not supplied*.....£34.95  
 A.M.A.S.  
 sampler & Midi interface.....£74.95  
 Trilogic Midi Interface.....£34.95  
*in/out/thru, 2 x out/ thru switched*  
 Aegis Sonix.....£39.95  
 Audiomaster 2.....£59.95  
 Dr. T's Midi Studio.....£45.95

**Music X**  
**NEW LOW PRICE**  
**FULL VERSION**  
 £75.95

## BOOKS AND MANUALS

Amiga for Beginners .....£12.95  
 Elementary Amiga Basic..£14.95  
 Advanced Amiga Basic..£18.95  
 AmigaDos (Burgess).....£14.95  
 Amiga Machine Language ..£14.95  
 Amiga Assembly Language..£14.45  
 The C Language, by K & R...£23.95

## SPECIALS

### PROTEXT V4.2

The Word Processor for those who want to handle words quickly and efficiently. No graphic fonts, just speed and a whole host of features aimed at producing text with the minimum of effort. Include Spell Checker and very powerful Mail Merge routines. Our favourite WP program on any machine. Includes manual and binder

RRP £99.95

**Our Price £64.95**

Also available, Protex Demo disc. Working version and great rolling demo, ideal for prospective purchasers and as a tutorial for owners.

**£5.00**

### PRODATA

Arnor's new database for 1 meg machines and above. Features excellent data layout facilities, including a wide range of printer effects, and uses many Protex editing commands.

RRP £79.95

**Our Price £55.95**

**PRODATA DEMO DISC £5.00**

### PRO-PACK!

Protex and Prodata  
**£114.95**

### MEMORY EXPANSIONS

1/2 Meg internal expansions for A500's. Real time clock and disable switch included.

**£48.95**

### VIDI-AMIGA

The best value video digitiser available for the Amiga. Grabs mono images in 16 shades from any domestic VCR (with composite video output) to be saved as IFF files for use with other graphic software.

**NTSC VERSION.....£79.95**

*300 X 200 RESOLUTION*

**PAL VERSION.....£95.95**

*300 X 256 RESOLUTION*

### VIDI-CHROME

The colour software upgrade for VIDI. Requires suitable video camera, either black & white or with B&W mode, as it uses red, green and blue filters to build up colour images.

RRP £19.95

**OUR PRICE £15.95**

### HITACHI VIDEO CAMERA

Basic black & white CCTV camera ideal for digitising and producing colour images with VIDI-CHROME.

**£219.95**

### VIDI-PACK

VIDI-AMIGA (PAL)  
 VIDI-CHROME  
 HITACHI VIDEO CAMERA  
**£299.95**

### SECOND DISC DRIVES

Quality external second 3.5" disc drive including disable switch. INCLUDES VIRUS-X UTILITY

**£62.95**

## PROGRAMMING

Hisoft Basic .....£58.95  
 Extend for above.....£15.95  
 Devpac version 2 .....£39.95  
 Lattice C version 5 ....£169.95  
 K-Gadget.....£19.95  
 K-Seka .....£34.95

## EDUCATIONAL SOFTWARE

Fun School 2, 2-6 years ...£12.95  
 Fun School 2, 6-8 years ...£12.95  
 Fun School 2, 8-12 years ...£12.95

Answerback Junior Quiz 6-11 ..£14.95  
 Discover Math, 10 and over ..£15.95  
 Discover Numbers, 6+ ....£15.95  
 Discover Alphabet, 6+ ....£15.95

Mavis Beacon Typing, 12+..£23.95

## ACCESSORIES

3.5" disc head cleaner .....£3.95  
 A500/2000 printer lead ....£6.95  
 Neoprene Mouse Mat .....£3.95  
 Quickjoy 2 Turbo Joystick ....£9.95  
 Comp. Pro 5000 Joystick..£13.95  
 Joystick/Mouse Switch ...£12.95

## DUST COVERS

All nylon fabric, not PVC type.  
 A500 keyboard .....£3.95  
 Philips CM8833 Monitor ...£4.95  
 Star LC10, Mk1, 2 or Colour..£4.95  
 Star LC24-10 .....£4.95  
 Panasonic KXP1081.....£4.95  
 Panasonic KXP1124.....£5.95  
 Citizen 120 D and Plus.....£4.95

## PRINTERS

All prices include 12 month guarantee, cable, a ribbon, VAT and delivery.

**CITIZEN 120-D PLUS £139.95**  
*Cheap 9 pin, with 2 NLQ fonts.*

**PANASONIC KXP-1081 £159.95**  
*Well built, NLQ in all sizes.*

**STAR LC-10 Mono £169.95**  
*Four NLQ fonts, double height.*

**STAR LC-10 Mono MARK 2 £189.95**  
*Fast version of the mark 1.*

**STAR LC-10 COLOUR £219.95**  
*Best value colour printer.*

**STAR LC24-10 £249.95**  
*Budget 24-pin, 5 fonts.*

**PANASONIC KXP-1124 £259.95**  
*Much better than the 24-10*

**CITIZEN SWIFT 24 £314.95**  
*Colour Upgrade Available.*

## RIBBONS

### COMPATIBLE RIBBONS

Star LC-10 Mono  
 Panasonic KXP-1080/1081  
 Citizen 120-D/Plus  
 Amstrad DMP2000-3250  
 Amstrad LQ3500  
**£3.95 each £7.00 a pair**

### Manufacturers original ribbons

Star LC-10 Mono .....£4.95  
 Panasonic KXP-1080/1081 ..£5.95  
 Star LC24-10 .....£5.95  
 Star LC-10 Colour.....£5.95

### Heat Transfer Ribbons

Produce iron on transfers.  
 Citizen 120-D.....£12.95  
 Star LC-10 Mono .....£13.95  
 Star LC-10 Colour.....£19.95

## DISCS

### 3.5" SONY/JVC BULK GUARANTEED

10 for.....£6.95  
 20 for.....£13.00  
 50 for.....£50.00

### BRANDED SONY 3.5" MF2DD

10 for.....£10.95  
 20 for.....£20.95

### REPLACEMENT POWER SUPPLY

Provides up to 30% more power to cope with add-ons  
**£44.95**

Please Note All prices include VAT and postage in the UK.

We ONLY advertise products actually available at time of going to press. We DO NOT advertise products "Due Shortly" as they rarely are!! Overseas orders welcome - Please write for prices

CALLERS WELCOME! MON-FRI 9.30am TO 5pm SAT 10am TO 4pm

**M.J.C. SUPPLIES (AF)**

40a Queen Street, Hitchin, Herts. SG4 9TS

Tel: (0462) 420847/421415/432897 for enquiries / Credit Card Orders

Prop M. J. Cooper

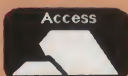



programs which run up to (it is claimed) 50 times faster than they would in standard Amiga BASIC.

Hampered by the compatibility with AmigaBASIC, HiSoft looks sluggish when compared on paper to its main competitors, but overall manages quite a reasonable speed. The main cavil with the system is the lack of an interpreter: programs must be tokenised and compiled before they can be tested. This adds unnecessarily to the development time.

Like most modern BASICs, HiSoft lacks line numbers, but the formatting of loops and so on is up to the programmer. Some editors do this automatically; it's all a matter of taste. The excellent editor is borrowed from Devpac – or is that the other way round? Although only offering single-file, single-window editing, it manages to be fast and effective. The curious system of using function keys for block marking could be better, though.

Unlike GFA BASIC (below) it features a simple interface to Intuition, although this must be criticised for lacking anything more useful than screens, windows and menus. This might seem useful enough, but in practical applications it can hamper the programmer and, inevitably, the user! To be fair, HiSoft have tried to remedy this by offering an extension to the language – called Extend. What they forgot to add was support for the ever-useful proportional gadgets. These crop up everywhere, from *DPaint*, to *Sonix* – even *Sleepy 3*! Their absence is definitely a mistake.

## GFA BASIC

GFA, Price varies

Definitely not compatible with anything other than GFA BASIC. When Version 3.0 first appeared, it was so full of holes it was a wonder it managed to survive the furious press critiques it received. Nonetheless survive it did, and GFA finally have a solid product.

Unlike several other third-party BASICs mentioned here, GFA BASIC is interpreted: those wanting a compiler have to pay another thirty quid for the privilege. The suggestion GFA is interpreted should not be taken as meaning it slow – far from it. With this release, GFA have demonstrated just what can be done with a “mere” interpreter and extracted performance previously unseen from the language.

Compiled programs are compact and very faaaaast! The compiler documentation even features a section on optimising raw BASIC code to make it even faster still. However, despite of what GFA might suggest, this section does require at least a rudimentary understanding of 68000 machine code to exploit the compiler to the full.

GFA's editor is a strange, though powerful beast and the language itself

has an unusual but well thought-out syntax. Notably line numbers have gone, as have multi-statement lines. This, coupled to the automatic indenting of loops and so on, forces programmers to produce clear, readable and logical code.

More unusual still, GFA supplies a complete interface to all the library functions found in the ROM. Common functions like opening Intuition windows and screens have their own calls, simplified for the beginner but powerful enough for the expert. From a programmer's angle it is difficult to see how long C compilers will remain in favour, since even complex programs would be easier to produce in BASIC's protective and friendly environment.

## AMOS

Mandarin, £49.95

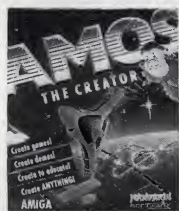

From Mandarin Software comes the long-awaited follow-up to their hugely successful *STOS* for the ST. *AMOS* is so new it deserved the full review now showing on Page 75 of this issue.



## C

Lattice C, HiSoft, £229  
Manx C, £160  
Lattice C++, HiSoft, £299

Devised by Brian Kernighan and Dennis Ritchie (from B, would you believe!) with the sole intent of writing operating systems – something which it is very good at. UNIX, GEM, Kickstart and many others were developed using C. However, the language has found many

BELOW: GFA Basic shows off its customised file request facility.

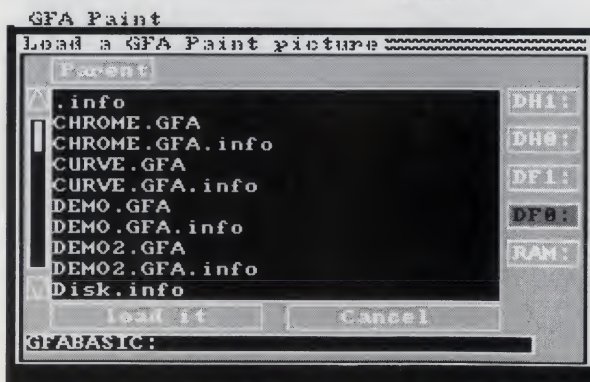

more uses than the one for which it was originally intended. This is the case with many languages once they become accepted – the few which have fallen by the wayside have done so for good reason, and remain unnamed.

The main advantage of C – as defined by its lovers – is its portability. In theory at least, a C program can be written on one machine and easily converted to run on another. This advantage has been whittled away somewhat, recently, with the advent of Modula 2 which is also extremely portable; and also, of course, has been reduced by WIMP systems. By definition, WIMP-based systems tend to be very machine specific, hence reducing the portability of software.

There are two main C compilers available for the Amiga: Lattice and Manx. Of the two Manx – being the cheaper – has the larger (or is that louder?) following, but Lattice appears to have the better back-up.

As main distributor HiSoft was keen to point out, Lattice is ANSI compatible and can produce code running more than 60% faster than Manx. But what's a few benchmark results among friends?

## Pascal

MCC Pascal, Metacomco, Price N/A

Invented by Professor Nicholas Wirth as a teaching language and named after the French philosopher, mathematician and physicist Blaise Pascal. The only Amiga version of Pascal has become, sadly, something of a rarity since the demise of Metacomco. Unless someone else picks up the baton, Amiga Pascal will become a thing of the past when existing supplies dry up. Those wanting to try this fascinating language should act now.

## Modula 2

Benchmark Modula 2, Price N/A

Another invention of Nicholas Wirth, Modula 2 shares many of the features first devised for PASCAL but without some of the drudgery of type checking and exacting syntactic specification. Modula is a logical progression from PASCAL and is seen by many as been the first in a new generation of computer languages.

Proof of this new-found usefulness comes in the form of Gold Disk's excellent *Advantage* spreadsheet which was developed in Modula, as opposed to the more usual use of C.



In order to gain the greatest speed from any computer, there is no option but to resort to the complex world of assembly language; and on the Amiga this means the 680x0 series.

At first glance assembler looks complex – because it is. More to the point assembler is long-winded and very prone to subtle bugs which cause spectacular crashes. A good 68000 development system MUST feature a debugger – machine code programming without one is like playing Russian Roulette with six bullets.

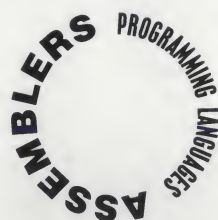

**Devpac 2**  
**Devpac Amiga, HiSoft,**  
**£59.95**  
**Devpac Developer (1Mb+),**  
**HiSoft, from £199**



From HiSoft comes the sibling to the hugely successful Devpac development system widely used by professional games programmers which should be a recommendation in itself. Many regard it as being the de facto standard by which all others must be judged – surprisingly there are a few pretenders to Devpac's crown. The system is supplied in three parts – Editor, Assembler and Monitor – and comes on two disks with an excellent manual.

The most impressive feature of Devpac 2 is the way the whole thing has been thought out. From within the editor (a good value package in its own right) it is possible to assemble the code to memory and immediately test it either at full speed or from the debugger. This reduces development time enormously over the over more conventional systems of edit, then assemble, (link), debug – where each part of the system is a separate entity.

For those wishing to use Devpac as part of a larger development system, it can produce linkable code which could be joined in a modular form to

compiled C, Modula 2, or even other assembly language modules. At around 70,000 lines per minute the assembler may not be the fastest, but considering Devpac has probably the best multi-tasking debugger available for the Amiga (and a massive following) it represents unequalled value for money.

**ArgAsm**  
**Argonaut, £79.95**

Comes from Argonaut Software, the home of *Starglider* and an impressive stable which can be expected to produce something special. Which is precisely what ArgAsm is, boasting a multiwindowed editor and claimed assembly speed of 250,000 lines per minute. It should have taken the programming world by storm, knocking Devpac straight off its perch.

The multi-windowed, multi-file editor is a joy to use – far better than Devpac's. Scrolling text in windows moves at blistering pace, giving some credence to the claims and showing it was written by people who consider speed of paramount importance. Also, like Devpac, ArgAsm can produce linkable code to use with other languages.

As a pure assembler, ArgAsm knocks spots off the competition in terms of performance alone; by no means enough to endear it to the buying public. The complete lack of any debugging facilities and heavy memory requirements (above 1Mb) are serious mistakes; even the dated K-Seka has a debugger. Argonaut use their own debugger in-house but refuse to release it on the grounds that its advanced facilities would only serve the needs of pirates. Fair comment, certainly – and a sad sign of the times.

Argonaut would have been better advised to think less about fancy features – like compatibility – and more

about releasing a product that worked. Yes, it's bugged: it sometimes fails to produce runnable code at all. ArgAsm could have been a masterpiece. It isn't.

**K - S e k a**  
**Kuma, Price around £50**

Mentioned here for the sake of completeness – even though Abacus' Assempro and Cape were not available. Seka is getting long in the tooth, but nevertheless a sizable number of programmers still swear by it – and at it too. It is capable enough – the ST and Amiga versions of *Wizball* (remember *Wizball*?) were written using it. The problem with Seka is it looks dated and the author has refused to update it, discouraged no doubt by the excellent competition. Even so, Seka wins hands down on price alone and it does have a debugger (of sorts).

The most notable features of the package include the weird editor – reminiscent of Ed, and the curious command structure! Assembly is very fast BUT this is definitely not a package for producing applications since no INCLUDE libraries are supplied. This means every \_LVO (Library Variable Offset) must be looked up in the reference manuals. A tedious operation even on a simple system like an ST, on the Amiga this is incomprehensible. Similarly, the documentation is rarefied in typical early Kuma style.

**Assem**  
**Metacomco, Price N/A**

Not unlike Kuma, the recently-demised Metacomco were one of the first to produce an assembler for the Amiga; like Seka, it looks crude in comparison to today's offerings. In its favour, Assem does use standard macros and can include files. From here it's downhill all the way. The editor supplied is Ed: suffice to leave that alone, *Cygnus Ed 2.0* is a better bet altogether. There is no debugger and the program only produces linkable files. Worst of all, Assem is supplied with ALink – this should also be replaced with BLink. Or better still, buy something else instead.

**RIGHT: In Devpac2 MonAm (the monitor) has a full five functional windows...**

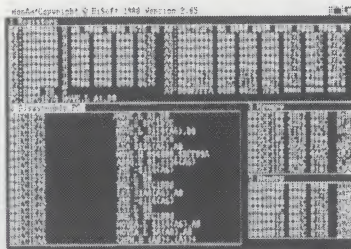

**BELOW: ArgEd is ready to assemble – loads options!**

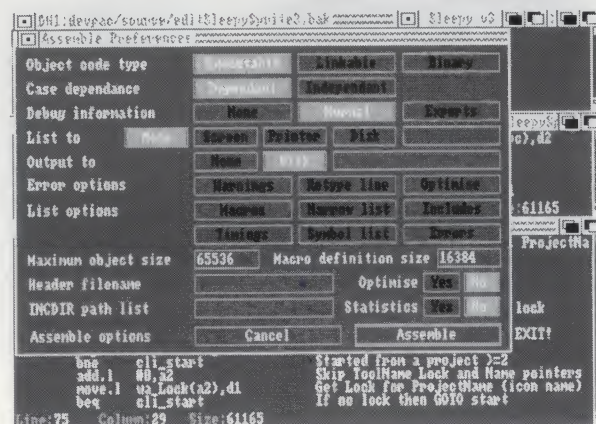

**F O R T R A N**  
**AC FORTRAN, £295**

The great grandfather of high-level languages and arguably the precursor to BASIC. Certainly much of the structure of FORTRAN can be found in today's

# MERLIN COMPUTERS

OUR PRICES ARE MAGIC

AMIGA 500 ONLY £379.00 INC BATMAN PACK

Amiga Flight of Fantasy .....£379.99

TRY THE ST'S MIDI POWER

CASIO MT 240 AN EXCELLENT LOW COST MIDI KEYBOARD £89.99  
OTHER CASIO KEYBOARDS ALSO AVAILABLE

1 MEG 3.5" DISK DRIVES ST AND AMIGA .....£75.00

ATARI STFM 1 MEG INTERNAL DRIVE UPGRADE .....£74.99

Special Offer on Amiga Upgrade Without Clock.....£49.00  
With Clock.....£59.00

The above drive is an easy to fit 2nd drive complete with mounting tray/facia

STAR LC 10 COLOUR PRINTER.....£215.00

STAR LC10 MONO PRINTER .....£169.99

STAR LC10 COLOUR HEAT TRANSFER RIBBONS - IDEAL  
FOR PRINTING YOUR OWN T-SHIRTS ETC.....£17.99

BLANK DISKS AT  
AMAZING LOW PRICES

10 3.5" DS/DD life time guaranteed .....£7.50

10 5.25" DS (per 10).....£3.50

Bulk buyers please phone for bulk prices

WE STOCK MANY ITEMS NOT LISTED HERE PLEASE PHONE  
FOR ANY ITEMS NOT LISTED

All prices include VAT and P & P

PLEASE NOTE ATARI 8-BIT OWNERS WE SUPPORT YOU

PLEASE PHONE FOR DETAILS

**MERLIN COMPUTERS**

62 Chester Road East, Shotton,  
Deeside, Clwyd CH5 1QB  
Tel: 0244 822597



# Learning has never been such fun!

Fun School 2 has been a tremendous success with more than 60,000 copies sold to date - even reaching Number 3 in the Gallup full-price software chart!

Each pack contains *eight* colourful and exciting programs designed by a team of educationalists, a colourful button badge and detailed instructions giving educational help.

The computer itself monitors the child's progress. The skill level - initially set by you - is automatically adjusted to suit your child's ability.

Now children can enjoy using your computer while they learn at their own pace.

Give your children an unfair advantage with **Fun School 2!**

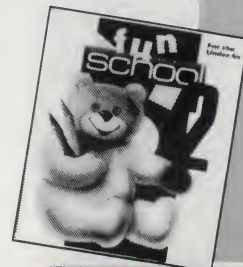

Under-6s

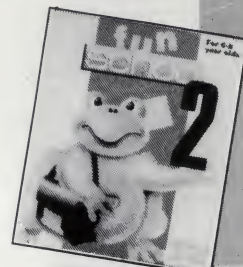

6-8 years

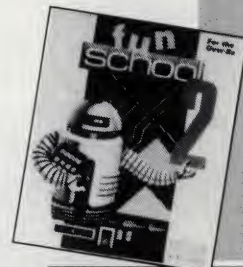

Over-8s

"The number one choice in our school"

- The Micro User

"Fantastic!"

- New Atari User

"It is fun, and your child will almost certainly learn too."

- Amstrad Action

"Full marks to Database"

- Amstrad User

On sale at top dealers nationwide and selected branches of WH Smith and Boots subject to availability

Order by telephone on 051-357 2961, or send your name, address, postcode and product code number together with a cheque payable to Database Software or your Access/Visa number and its expiry date. Postage free in the UK. Add £2 per program for Europe & Eire (£5 Overseas).

Send to:

Database Direct, FREEPOST, Ellesmere Port, South Wirral L65 3EB.

Prices from  
£9.95

Format	Under 6s		6-8 years		Over 8s	
	Tape	Disc	Tape	Disc	Tape	Disc
Spectrum	9094	9095	9096	9097	9098	9099
Commodore 64	9064	9065	9066	9067	9068	9069
Amstrad CPC	9179	9180	9181	9182	9183	9184
BBC Micro/Electron			2239	2242		
BBC B+/Master 40 Track		2240		2243		2249
BBC B+/Master 80 Track		2241		2244		2250
Atari ST		9192		9193		9194
Amiga		9842		9843		9844
PC 5.25"		5764		5765		5766
PC 3.5"		5767		5768		5769
Archimedes		2900		2901		2902

8-bit formats: £9.95 (cassette) £12.95 (disc)

16/32-bit formats (ST, Amiga, PC, Archimedes): £19.95

Please quote the product code number (as shown above) when you order.

DATABASE EDUCATIONAL SOFTWARE

## AUTHORISED DEALER FOR \* AMIGA \* STAR \*

### AMIGA (UK MODELS ONLY)

B2000 with 1Mb Chip RAM.....949.00  
B2000 + Stereo Colour Monitor ....1195.00  
B2000 + 48/80Mb Autoboot +  
Stereo Mon.....1595/1999  
Amiga 500 Flight Of Fantasy Pack.....359.00

### PRINTERS

Citizen 120D + .....129.95  
Star LC-10 .....159.00  
Star LC-10 Colour .....199.95  
Star LC24-10 24 pin.....239.00  
Okimate 20 consumables  
normally in stock .....PHONE

### MONITORS

Philips 8833 Stereo Colour Monitor...249.00  
Quadram Multi-scan .....349.00  
Commodore 1084S Stereo .....PHONE

### DISK DRIVES

A2000 Autoboot 48Mb Drive .....399.00  
A2000 Autoboot 80Mb Drive .....549.00  
Amiga A590 Autoboot 20Mb Drive.359.00  
Internal 3.5" Disk Drive for A500 or  
A2000 P&P £2 .....69.95  
External 3.5" Drive for Amiga - Disable  
Sw & Thro' Port P&P £2 .....59.95

### MISCELLANEOUS

Commodore A501 RAM/Clock 512Kb.99.95

A500 RAM/Clock 512K with  
Disable Sw.....59.95  
A500 RAM/Clock 1.8Mb Fully Populated 209.00  
A500 Compatible Power Supply .....49.00  
Kickstart V1.3 ROM for A500/2000 ..28.00  
1Mb Fat Agnus 8372A.....59.00  
CIA Chip 8520 .....15.00  
A2000 RAM 8Mb Populated with 2Mb..299.00  
miniGEN low cost Genlock .....99.95  
Vidi-Amiga PAL Frame  
Grabber inc filters .....129.00  
RGB Composite Video Splitter .....69.95  
Surge Protector 4-Way Distrib Unit...15.95  
Surge Protector 13A Plug/3-Way  
Adaptor .....12.95/19.95

### SOFTWARE

TV\*TEXT Professional Titler.....129.00  
TV\*SHOW Presentation .....54.95  
TV\*TEXT + TV\*SHOW .....169.00  
Pro Video Plus Titler .....189.00  
Digiview Gold V4 Digitiser.....119.95  
Home Office Kit: Kindwords 2,  
Pagesetter 1.2, Maxiplan 1.9, InfoFile,  
CalcFonts & Artists Choice.....129.95  
Starter Kit: KindWords 2, Golf,  
Excellence! W/P .....139.00  
Professional Page DTP .....179.95  
X-CAD Designer CAD .....79.95  
Music-X.....175.00  
Midi Interface for above .....34.95

ALL PRICES INCLUDE 15% VAT  
CARRIAGE £5 (EXPRESS £10) SOFTWARE £2  
Prices subject to change without notice. E. & O. E.

*Delta Pi Software Ltd*

8 Ruswarp Lane, WHITBY, N. Yorks YO21 1ND  
TEL/FAX: 0947 600065 (9am - 7pm)





BASIC. The name is an acronym for FORMula TRANslation language which describes it very well. FORTRAN appeared very early on because it was devised for scientists who needed to be able to write programs which expressed their formulae in (more or less) simple English, something which was impossible in other languages around at the time.

Although FORTRAN is still regarded very much as a scientific language – the stuff of minis and mainframes – at least one software house has seen fit to produce a version for the Amiga. AC FORTRAN is available from larger suppliers including HB Marketing. It looks very promising indeed.

**APL**  
**MicroAPL, £99.95**  
**basic version , £299.95**  
**with 68881/68882 support**  
**and faster libraries**



Must rank as one of the most peculiar languages around, since the major body of its definition relies on a super-set of special symbols unique to it. The name APL comes from 'A Programming Language', probably because its inventor, Dr Kenneth Iverson, couldn't think of a better way to describe listings which amount to little more than runic diagrams. Perhaps the ancient Egyptians invented computing after all?

Like many fringe languages though, APL has a fiendishly dedicated band of followers – some of whom are responsible for bringing this ISO standard implementation to the Amiga.

## REXX

Is a relative newcomer to the computing scene since it appeared as recently as 1985. It should be made clear from the outset ARexx (William Hawes' Amiga implementation of REXX) has not been accepted as a language in its own right, but adopted as a script language for controlling other applications. However, this should not be seen as taking anything away from ARexx, since it is without doubt a very powerful language, and quite capable of producing stand-alone programs.

Very briefly, the language is not

entirely dissimilar to BASIC – although this may be doing it some injustice. It comes on a single disk with a clearly written manual explaining the implementation and the differences between Amiga REXX and Colishaw's original specification. Beginners are advised to refer to this for a better explanation. ARexx programs use a resident process – that is, a program sitting in the background which applications use to communicate with ARexx. ARexx programs themselves are interpreted at run time in much the same way as one might start a CLI program.

Bluntly, ARexx is best viewed as a means to an end: that is to customise other software packages and produce, in effect, meta-applications based around them. Typical examples of software supporting ARexx interfaces are *Superbase Professional* (database), *Cygnus Ed* (text editor), *SuperPlan* and *Advantage* (spreadsheets). Since Commodore have been far-sighted enough to include ARexx with Workbench 2.0, this list should get longer; but only time will tell.

**LOGO**  
**Commodore £49.95,**  
**included in 'Class Of The 90's' bundle**



Quite where the name LOGO comes from is unclear. Inventor Seymore Papert designed it – like PASCAL – primarily for teaching purposes. LOGO's syntax is meant to encourage clear, logical thinking which should be present in anyone wishing to engage computing as a profession.

LOGO is best known for its "turtle graphics", a technique for creating a solid idea a child's mind can key on. It gives the teacher and child a common ground to communicate on. Giving movement commands to a turtle is something the child can envisage more easily than a graphics cursor. The idea of the poor turtle having a pen shoved through its shell has something psychologically doubtful about it. Moreover, with the current fad, "Teenage Mutant Ninja Turtles – Heroes In A Half-Shell" what next – "LOGO Turtles – Heroes Impaled On A Ball-Point"?

**FORTH**  
**Helios FORTH,**  
**HB Marketing, £49.95**

Invented by Charles Moore and Elizabeth Rather in the early '70s as a control language for radio telescopes, no less. Its name derives from the

**Thanks to the following for their kind support:**

**GFA: 0734 794941 (GFA BASIC)**  
**HB Marketing: 0753 686000 (FORTH, FORTRAN)**  
**HiSoft: 0525 718181 (HiSoft BASIC + Extend, Devpac, Lattice Cv5)**  
**Kuma Computers: 0734 844335 (K-Seka)**  
**Mandarin Software: 0625 859333 (AMOS)**  
**Micro APL: 071 922 8866 (APL 68000)**  
**Precision Software: 081 330 7166 (ARexx)**

**For lack of space, faulty disks, problems with suppliers etc. the following have not been included: AC BASIC, F-BASIC, Power BASIC, AiRT, Manx C, Lattice C++, Cape 68K. Freeoow! The following may also be available, but Amiga Format could not find any suppliers: LISP and ALGOL.**

inventors' belief it was a fourth-generation language. Unfortunately, the machine used to develop early compilers only allowed five-letter filenames – so the "u" was dropped, and the language was named.

Since then, FORTH has been adopted and evolved beyond the imagination of its inventors. At least two major support groups exist, The FORTH standards team and the FORTH Interest Group (FIG) each defining their own specification for how the language should behave. However, due to the design concept of FORTH, it is difficult to define a standard as such; only to define what words should exist. FORTH is an almost unique language in that it is completely defined in terms of itself!

A FORTH program is no less than an extension of the language. Indeed, this has been further extended by advanced FORTH programmers who have used this concept to invent new, FORTH-like languages. At the time of writing HB Marketing, the only company known to be working on an Amiga FORTH, were unable to advise Format of a release date; expect it soonish, rather than later – watch this space...

**Next month MARK SMIDDY examines more of the tools that programmers use to create**

**RIGHT: AREXX in action, using Cygnus Ed which supports it.**

**BELOW: This turtle has built himself a proper LOGO house...**

**BOTTOM: Helios FORTH shakes its funky stuff.**

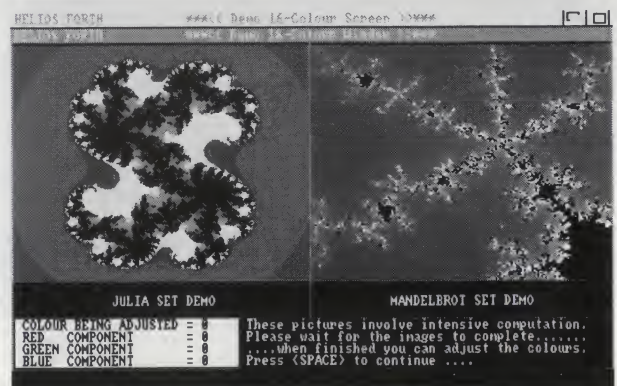
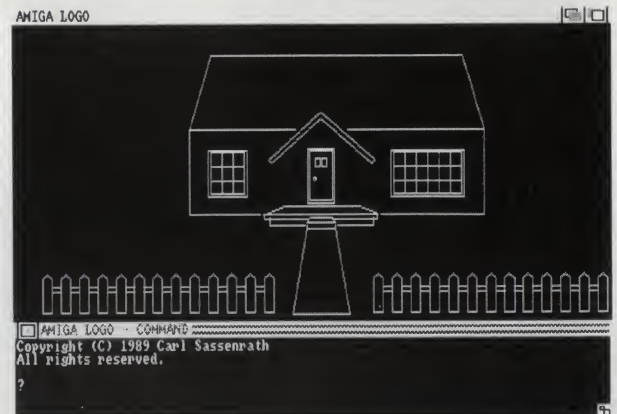
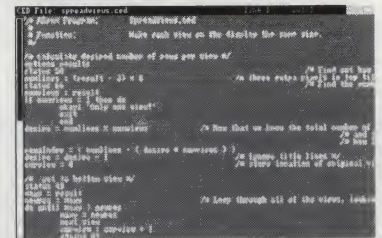

# But Seriously

# HiSoft

## HiSoft Devpac 2 Assembler/Debugger

### "Devpac has it all plus a lot more" - ST Format, Dec 88

Consistently acclaimed as the best assembler development system for the Amiga, Devpac Version 2 is a complete package including:

- ✓ Powerful, extremely fast assembler with macros, conditional assembly, include, optimisations, local labels, multiple hunks, producing executable or linkable o/p.
- ✓ Advanced, multi-window symbolic debugger with single-step, dynamic conditional breakpoints, full expression evaluator, disassembly to disk etc.
- ✓ Integrated, fast and easy-to-use editor so that you can create, assemble, debug, edit, assemble etc. all without leaving the editor. CLI versions are also included for those who have strong editor preferences.
- ✓ Fast Linker, standard 1.3 Include files and full documentation.

With full technical support and constant improvement, Devpac has no rivals - most of the top software houses who develop on the Amiga use Devpac - why don't you?

## Lattice C Compiler Version 5.05

### "... a very professional package" - Transactor May 89

Quite simply, Lattice C 5 is the best C development system you can buy for your Amiga. Having sold more than 12,000 copies worldwide, the package is used by professionals and hackers alike - just look at what you get:

- ✓ Powerful, enhanced C compiler with full 68020/68030/68881/68882 support plus screen editor, linker, assembler, librarian, code profiler, disassembler and more.
- ✓ Advanced global optimiser which gives your programs performance improvements of up to 40%. You can optimise for execution speed or program size.
- ✓ The CodeProbe source level debugger with 4 separate windows, allowing you to single-step through source code, set source line breakpoints, examine, modify and continuously monitor your C variables and much, much more - invaluable.
- ✓ Comprehensive two volume, ring-bound documentation in a quality package.

Lattice C 5 has improved ANSI compliance, function prototyping, is multi-tasking and re-entrant, has nearly 300 library functions and comes complete with full technical support.

## HiSoft BASIC Version 1.05 with Extend

### "HiSoft BASIC is an excellent choice" - ST/Amiga Format March 89

HiSoft BASIC is the answer to your programming prayers, an extremely fast, interactive, standard and easy-to-use system, used by many top software houses all over the world.

- ✓ Modern, structured programming with long IFs, multi-line functions, sub-programs, REPEAT, DO, CASE, full recursion, local & global variables etc.
- ✓ No limits to your program size and no limits on the size of any variable, memory permitting, plus the ability to link easily with C and assembler programs.
- ✓ Totally interactive system with easy-to-use Intuition editor allowing mistakes to be corrected simply and quickly, substantially reducing development time.
- ✓ Extremely close compatibility with AmigaBASIC and Microsoft PC QuickBASIC 3.

Complementing HiSoft BASIC, **HiSoft Extend** is a comprehensive set of library routines for IFF files, gadgets, menus, sub-menus, sound, HAM mode and more.

Normally costing £19.95, we are including this package, **free of charge**, until 1 September 1990, if you use the order form below.

## Special Offer to Amiga Format Readers

Use the order form below to order any HiSoft products and we will send you, totally free of charge, an Amiga Starter Pack consisting of: a mouse mat with the Amiga ASCII character set, a stylish disk wallet holding up to 8 disks and 4 quality double-sided diskettes; a package worth over £14 if bought elsewhere!

Please rush me the following software together with my free starter pack.  
(all prices include 15% VAT and postage and packing within UK. Please phone for export details)

- Devpac Amiga 2** £59.95
- Lattice C 5.05** £229.00
- HiSoft BASIC & Extend** £79.95

Name:  Date:

Address:

I wish to pay by:

- Cheque/POs  Access
- Visa

Card No:

Expiry Date:  Signature:

**HiSoft**  
High Quality Software

The Old School, Greenfield  
Bedford MK45 5DE UK  
Tel: (0525) 718181  
Fax: (0525) 713716

# SOFTMACHINE

## AMIGA HARDWARE/PERIPHERALS/BOOKS

### A 500 FLIGHT OF FANTASY

F29 Retaliator  
Rainbow Islands  
Escape from the Planet  
of the Robot Monsters  
Deluxe Paint II  
**£374.99**

### A 500 BATMAN PACK

Batman - The Movie  
New Zealand Story  
Interceptor  
Deluxe Paint II  
**£374.99**

### A 500 CLASS OF THE 90'S

Superbase Personal  
Maxiplan 500  
Publishers Choice  
Dr T's Midi Recording Studio  
Amiga Logo  
BBC Emulator  
Deluxe Paint II  
Midi Interface  
10 Disks + Disk Wallet  
Mouse Mat  
**£524.99**

### AMIGA B2000 SYSTEMS

Latest revision UK B2000's  
available singly or bundled with  
20/40 Mb Hard drives and/or PC-  
XT/AT Bridgeboards.  
**Please call for latest prices**

### SOFTMACHINE STARTER PACK

Deluxe Mouse Mat  
Quality Dust Cover  
Drive Head Cover  
10 TDK MF2DD Disks  
A500 Dust Cover  
**ONLY £20\***

\*When purchased with any Amiga  
computer... Offer limited to 1  
starter pack per Amiga  
purchased

A590 20Mb Hard Drive...£364.99  
A501 Ram Exp/Clock...£94.99  
A520 Modulator...£24.99  
  
1084S Colour Monitor...£259.99  
1084S Bought with A500...£250.00  
A1011 Disk Drive...£119.99  
Cumana 5.25" Drive...£94.99  
A590 20 Mb Hard Drive...£379.99  
A501 Ram Exp/Clock...£94.99  
A520 Modulator...£24.99  
A1352 Mouse...£34.99

Philips 8833 Monitor...£254.99  
Cumana 1Mb 3.5" Drive...£69.99  
Cumana 5.25" Drive...£119.99  
Vortex 40 Mb Hard Drive...£499.99  
0.5 Mb Ram Exp/Clock...£194.99  
Hitachi Camera + lens...£219.99  
Digiview 4...£124.99  
Vidi Amiga...£97.50  
Colourpuc...£434.99  
Type 10 Handy Scanner...£254.99  
Minijet...£97.50  
Rendale 8802 Genlock...£187.50  
Rendale 8806 Genlock...£674.99  
Cherry A3 Tablet...£459.99  
Demonn Modem...£94.99  
Designer Modem...£104.99  
Pro IV Modem...£389.99  
Linnet Modem...£144.99  
Digiview 4...£244.99  
Linnet 2400 Modem...£359.99  
Midi Master Interface...£29.99  
Omega Midi Interface...£29.99  
A.M.A.S...£79.99  
Futuresound...£74.99  
Perfect Sound...£67.50  
Contriver Mouse...£24.99  
10 x Sony Bulk 3.5"...£8.99  
10 x Sony MSD 3.5"...£12.99  
10 TDK MF2DD 3.5"...£12.99  
3.5" 40 Cap Lockable Box...£5.99  
3.5" 80 Cap Lockable Box...£7.99  
3.5" 150 Cap Lockable Box...£19.99

Adv. Amiga Basic...£18.95  
Adv. Sys. Prog. Guide Am...£32.45  
\* 3D Graph Prog Basic...£18.45  
Amiga Applications...£16.95  
Amiga Assembly Lang Pr...£14.45  
Amiga Basic Inside + Out...£18.95  
Amiga C Adv. Prog...£32.45  
Amiga C for Beginners...£18.45  
Amiga DOS...£14.95  
Amiga DOS Inside + Out...£18.45  
Amiga DOS Quick Ref...£8.95  
Amiga Dos Ref. Guide...£14.95  
Amiga Desktop Video...£18.45  
Amiga Desktop Vid. Guide...£18.45  
\* Disk Drives Inside + Out...£27.95  
Amiga for Beginners...£12.95  
\*Guide Gra/Sound/Com...£17.45  
Amiga Gra. Inside + Out...£32.45  
\*Amiga Hware. Ref. Man...£21.95  
Amiga Mach. Lang. Guide...£21.95  
Amiga Machine Lang...£14.95  
\*Microsoft Bas. Prog.  
Guide...£18.45  
\*Prog. Handbk. Vol. 1...£23.95  
\*Prog. Handbk Vol 2...£23.95  
Amiga Prog Guide Comp...£17.45  
Amiga Prog Guide Weber...£18.45  
\*ROM Kemal Ref Man...£28.95  
\*ROM Kemal Ref Man Lib...£29.95  
Amiga Sys Prog Guide...£32.95  
Amiga Tricks and Tips...£14.95  
Be coming on Am. Art...£18.45  
Beginners guide to Amiga...£16.95  
Comp 1st Book of Amiga...£16.95  
Computer 2nd Bk of Am...£16.95  
Elementary Amiga Basic...£14.95  
Inside Amiga Graphics...£16.95  
Inside the Amiga with C...£24.50  
Kids + the Amiga...£15.95  
More Tips and Tricks...£18.45  
Prog Guide to Amiga...£23.95

Please ring for prices/availability on any hardware/software/peripherals not listed. (Full price list on request)



Please make cheques/postal orders payable to SOFTMACHINE. All items subject to availability.  
All prices include V.A.T. & Delivery. All prices subject to change without notice. E.&O.E.

## SOFTMACHINE

Dept. AMF 8, 36 Guernsey Road, Sunderland SR4 9RR. Telephone: 091 385 7426

## SOFTWARE

### WORD PROCESSING

Excellence...£136.95  
Kind Words 2...£34.50  
Protext...£69.95  
Pro Write V3...£102.50  
Scribble Platinum...£41.50  
Transcript...£32.50  
Word Perfect...£176.95

### DATABASES

Acquisition 1.3...£169.95  
K-Data...£34.95  
Prodatal...£56.95  
Superbase Personal...£42.50  
Superbase Personal 2...£69.95  
Superbase Professional...£169.95

### SPREADSHEETS

Advantage...£79.95  
DGCcalc...£27.95  
K-Spread 2...£42.50  
Superplan...£112.50

### LANGUAGE/COMPILERS/ETC

AMOS...£34.95  
A-Rexx...£32.50  
Arqasm...£49.50  
Aztec C Developer...£199.95  
Aztec C Professional...£112.95  
Benchmark Modula 2...£137.50  
Benchmark Libraries...£72.50  
Devpac 2...£43.50  
Enhancer (WB 1.3)...£14.95  
GFA Basic V3 Compiler...£22.95  
GFA Basic V3 Interpreter...£36.95  
Hisoft Basic...£36.95  
Hisoft Extend...£15.95  
K-Seka Assembler...£34.95  
Lattice C V5...£174.95

### UTILITIES

B.A.D...£32.50  
B.B.C. Emulator...£39.95  
Cross Dos...£24.95  
Gomf v.3...£27.95  
Hisoft Extend...£15.75  
Interchange...£39.95  
Mac 2 Dos...£69.95  
Mailshot Plus...£34.95  
Masterpiece Fonts...£137.50  
Power windows V2.5...£54.95  
Project D...£32.50  
Quarterback...£39.95  
Superback...£41.95  
Ultra Card Plus...£74.95  
X-Copy V2...£16.95  
X-Copy V2.1 + Hardware...£26.95

### CAD/GRAPHICS/ANIMATION

Animagic...£62.95  
\*Architectural Design...£22.50  
Can do...£101.95  
C-Light...£39.95  
Comic Setter Clip Art...£17.50  
Deluxe Paint III...£59.95  
Deluxe Photolab...£54.95  
Deluxe Print II...£36.95  
Deluxe Video III...£59.95  
Design 3D...£62.95  
Digi Paint 3...£54.95  
Digitimate 3 (needs A-Rexx)...£33.95  
Fantavision...£32.50  
\*Future Design...£22.50  
\*Human Design...£22.50  
\*Interior Design...£22.50  
IntroCAD...£47.50  
\*Microbot Design...£22.50  
Move Setter...£39.95  
Page Flipper + FX...£69.95  
Page Render 3D...£108.50  
Photon Paint 2...£29.95

### DESKTOP PUBLISHING

Home Office Kit...£116.95  
Pagesetter V2...£77.95  
Pagesream (USA)...£127.95  
Professional Page...£193.50  
PP Compugraphic fonts...£112.50  
PP Structured Clip Art...£35.95  
PP Templates...£35.95  
PIXmate...£39.95  
Professional Draw V2...£159.95  
Pro Video Plus...£193.50  
The Director...£47.50  
The Director's Toolkit...£27.50  
TV Show V2...£57.50  
TV Text Prof...£104.95  
Video Generic Master...£54.95  
Video Tiller...£85.95  
Video Wipe Master...£54.95  
X-CAD Designer...£86.95  
Zeotrope...£74.95  
\*state Sculpt or Videoscope

### MUSIC

A Drum...£32.50  
Bars and Pipes...£184.95  
Deluxe Music...£54.95  
Instant Music...£184.95  
Music X...£34.95  
Quartet...£49.95  
SoniX...£49.95  
Track 24...£74.95

### COMMUNICATIONS

K-Comm 2...£34.95  
Ruby Comm...£54.95

### ACCOUNTS

Cashbook Combo...£49.50  
Cashbook Controller...£34.95  
Desktop Budget...£32.50  
Final Accounts...£21.95  
Home Accounts...£21.50  
Personal Accounts Plus...£24.95  
Small Business Acc. Cash...£56.50  
Small Business Acc. Xtra...£79.95  
Small Business Acc. Plus...£156.50  
System 3...£34.95

## 3 1/2" BENCHMARK DISKS AND BOX OFFER

10 3 1/2" DS/DD + 50 Cap. Box...£10.95  
20 3 1/2" DS/DD + 50 Cap. Box...£18.95  
30 3 1/2" DS/DD + 50 Cap. Box...£23.95  
40 3 1/2" DS/DD + 50 Cap. Box...£28.95  
50 3 1/2" DS/DD + 50 Cap. Box...£33.95  
20 3 1/2" DS/DD + 100 Cap. Box...£19.95  
40 3 1/2" DS/DD + 100 Cap. Box...£29.95  
50 3 1/2" DS/DD + 100 Cap. Box...£34.95  
70 3 1/2" DS/DD + 100 Cap. Box...£44.95  
100 3 1/2" DS/DD + 100 Cap. Box...£55.95

## DISK BOXES

3 1/2" 50 CAPACITY...£5.25  
3 1/2" 100 CAPACITY...£6.50

BOTH ABOVE INC. LOCK & DIVIDERS

3 1/2" 10 CAPACITY LIBRARY  
CASE IN PACKS OF 5...£4.75

## MOUSE AND BITS

Replacement Mouse for Amiga...£19.99  
Rigid Double Sided Mouse Pad...£4.50  
Mouse Pocket...£2.50  
Rigid Pad & Pocket together...£6.00

## ACCESSORIES ETC.

2 Piece Universal Printer Stand...£6.75  
14" Tilt & Turn Monitor Stand...£14.50  
Printer & Monitor Stand together...£18.25

## 3 1/2" BENCHMARK DISKS DS/DD 135TPI

25...£15.95  
50...£27.95  
100...£49.95  
200...£92.95  
400...£177.95

Inc. Labels.  
**COLOURED BENCHMARK IN RAINBOW PACKS OF 5 COLOURS, RED, YELLOW, GREY, GREEN AND FOG WHITE.**

25...£17.95  
50...£34.95  
100...£63.95  
200...£117.95  
400...£223.95

Inc. Labels.

All Benchmark Disks carry a lifetime warranty. If your data is important then buy Benchmark Brand.

## 3 1/2" UNBRANDED DS/DD 135 TPI

All disks 100% cert. & guaranteed

100...£44.00  
200...£84.00  
400...£160.00  
600...£235.00  
800...£302.00  
1000...£364.00

Inc. Labels.

## DATA SWITCHES AND CABLES

2 way 36 pin Cent...£14.50  
2 way 25 pin D-Type...£12.50  
X Over 36 pin Cent...£19.22  
X Over 25 pin D-Type...£18.22

All lines switched.

Amiga Printer Cable 2 mtr...£7.25  
36-36 Cent m/m 2 mtr...£8.25  
25-25 D-Type m/m 2 mtr...£7.25  
All lines connected.

## AMIGA DISK DRIVE

AMIGA 3 1/2" EXTERNAL DISK DRIVE 1 MEG (880K)

\* FOR AMIGA 500 or 1000  
\* ON/OFF SWITCH  
\* THROUGH PORT  
\* QUIET MECHANISM  
\* SLIM CASE (METAL)  
\* 1 YEAR WARRANTY

## OUR PRICE £64.50

### EXTRA LABELS 3 1/2"

100 3 1/2" LABELS...£3.50  
500 3 1/2" LABELS...£10.00  
1000 3 1/2" LABELS...£15.00

ALL PRICES INCLUDE VAT & P&P. UK ORDERS ONLY

Cheques and Postal Orders to:



24 HOUR ORDERLINE 0597 87784

## Manor Court Supplies Ltd

OFFICE 9AM-5.30PM Mon-Fri

Telephone: 0597 87 792 Fax No: 0597 87 416

Dept AF8, Glen Celyn House, Penybont,  
Llandrindod Wells, Powys, LD1 5SY

EDUCATION AND GOVERNMENT ORDERS WELCOME

# MCS



# TRICKS WITH Coppers

SPECIAL

Intuition contains a wealth of tools for helping the programmer create good-looking and effective programs, so with a bit of care you can build programs which easily compete with the professional offerings! Gadgets, menus, requesters and their ilk look most effective if they are set against an appropriate background – so it's worth spending a bit of time experimenting in this area.

There are three basic approaches that can be used to provide a display background. Firstly you can 'draw' a picture using a program like *DPaint* and then read the resulting IFF file into your program to provide the necessary details. With this approach the single background picture can hold any information (program name, user instructions etc) which, in the final display, will not need to change.

Secondly, you can use graphics routines to build up a suitable background by writing directly into the display memory. And thirdly you can use the Amiga's co-processor, the 'Copper', to do the job.

This latter approach is used in hundreds of demos and in quite a few commercial programs as well. Many of them opt for a simple but effective horizontal background shading. To be honest I could give you half a dozen lines of C or assembler code and say this is how you can do it.

I could... but that approach is really only any use if you know what the hardware does and know how to generate the colour values anyway. I'll assume that since you're reading this article you don't know about such things and, because it's not going to be that obvious how the final C code works, I'll tackle the explanations right from first principles.

## From the Top

The main problem has little to do with the Copper or the Amiga at all – it's to do with working out how best to

Here's your chance to find out a bit about multi-colour background shading – **PAUL OVERAA** looks at some of the underlying ideas!

generate series of cycling numbers. Admittedly these numbers, at the end of the day, will be jammed into colour registers – but as far as the underlying principles of the thing go that's neither here nor there.

Essentially we need to step through the lines of the display and change the colour as we go, using a scheme like this...

```
for ( i = 0; i<SCREENLINES; i=i+1 )
{
  Identify new colour 'j' to be used
  Set line 'i' to colour 'j'
}
```

The variable *j* must be kept within the range of colour numbers suitable for the screen. The obvious choice is to combine the changing value of *i* with a modulus function so that we generate a value of *j* which will always stay within the chosen limits.

```
for ( i = 0; i<SCREENLINES; i=i+1 )
{
  j = i % n
  Set line 'i' to colour 'j'
}
```

If *n* is set to 5 then *j* will take values from 0 to 4 and the colours used down the screen will follow this pattern... '0 1 2 3 4 0 1 2 3 4 0 1 2 3 4' and so on.

In practise it's usually better to produce an oscillating sequence rather than a direct cycling sequence and so instead of generating the above pattern we'd opt for one based on a '0 1 2 3 4 3 2 1 0 1 2' type of

arrangement. To do this we have to modify the generating function slightly. Here's one form which does the trick...

```
for (i=0; i<SCREENLINES; i=i+1)
{
  if ((i/4) % 2 == 0) { j=j+1; }
  else { j=j-1; }
  Set line 'i' to colour 'j'
}
```

This code does produce the required result, but most programmers would use C's increment/decrement operators combined with an 'implied' *i* test, so they'd write the loop like this...

```
for (i=0; i<SCREENLINES; i++)
{
  if ((i/4) % 2) { j--; } else { j++; }
  Set line 'i' to colour 'j'
}
```

Even this form can be improved by using the ternary operator *?* to select the operation performed on *j*...

```
for (i=0; i<SCREENLINES; i++)
{
  ((i/4) % 2) ? j-- : j++;
  Set line 'i' to colour 'j'
}
```

That's dealt with the calculation of the colour values, so now all we need to worry about is how to set a screen line to a particular colour.

One way of doing it would be to use a standard line drawing function, so we could use the graphics function *SetAPen()* to set the pen colour for

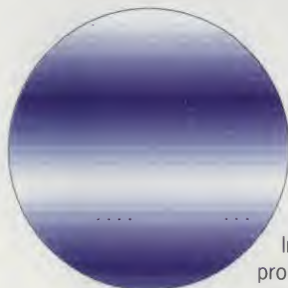





drawing, then use Move() to position the pen at the start of a screen line, and finally use the Draw() function to perform the actual line filling operation. If we added this type of code to our existing loop we'd end up with a typical shading routine – this example uses a screen's rastport pointer to completely fill a screen display with an oscillating colour pattern...

```
for (i=0;i<SCREENLINES;i++)
{
(i/4) % 2 ? j-- : j++;
/* j selects the colour register */
SetAPen(rastport_p,j);
/* set APen to the selected colour */
Move(rastport_p, 0, i);
/* move to the start of the line */
Draw(rastport_p, SCREENWIDTH, i);
/* draw the line */
}
```

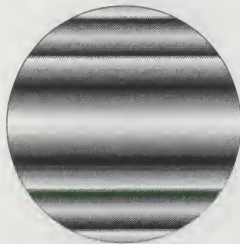

You can of course modify the amplitude of the oscillation range – the expression (i/n) % 2 ? j-- : j++; will oscillate between 0 and n inclusive. Secondly, you can add a fixed amount to the final j value produced – so that any given oscillating function can be made to select any chosen range of colour numbers.

### Making the Most of the Amiga Hardware

On the Amiga we don't have to use routines like Move() and Draw() at all because we can use the Copper to jam colour values into the appropriate colour registers as the video beam moves down the screen.

To do this we have to build a list of copper instructions and then link this list into the screen's viewport. As you probably know the Copper has three instructions: WAIT, MOVE and SKIP. We'll be using WAIT, to wait for the video beam to reach a particular

screen line, and MOVE to force a colour value into a colour register. Where do we get the colour value? Well, since I've spent half this article talking about loops that can generate a suitable series of numbers we might as well use this approach to calculate our colours!

So, how do we actually do it? Here's a step-by-step account of the things that have to be done (I've skipped details of variable declarations etc., because you'll find all that on the disk version...)

First we need space for a list of copper instructions. In the disk example I've used an AllocMem() call...

```
c=AllocMem(12L,MEMF_CHIP|MEMF_PUBLIC|MEMF_CLEAR);
```

Next, we make use of a system macro called CINIT to initialize our copper list memory...

```
CINIT(c,800L);
```

Now all that's needed are the Copper instructions themselves: I'm using a loop which works out the necessary instructions for each screenline, calculating the colour with a function similar to the oscillating function we discussed earlier.

The CWAIT system macro creates copper instructions which say 'wait for the video beam position to reach co-ordinates (j,0)'. The CMOVE macro produces the instructions which jam the colour I've calculated into the background colour register (register 0).

The result of the following loop, therefore, is a list of Copper instructions which continually change the value of colour register 0 in the split seconds as the electron beam moves down the screen...



```
for (j=0;j<SCREENHEIGHT;j++)
{
(j/15) % 2 ? Blue- : Blue++;
CWAIT(c,j,0L);
CMOVE(c,custom.color[0],Blue);
}
```

Finally we terminate the Copper list with an impossible wait instruction (that's what the CEND system macro does), link our newly created Copper list into the viewport, and remake the display like this...

```
CEND(c);
global_viewport_p->UCopIns=c;
MakeScreen(global_screen_p);
RethinkDisplay();
```

So that's it: Grab some memory (or create a static list if you like), initialize it, use a loop to generate some 'wait and jam a colour into a register' instructions, link the list into the viewport, and then remake the display.

Once you know what you're doing you can squash the whole 'Copper list generation' thing into three or four lines of C code... so don't let anyone kid you that it's difficult!

You'll find a short C demo, called *Coppertest*, on the Coverdisk: The source code is called 'coppertest.c'. I've kept the code to the bare minimum... it just opens the required system resources, installs a copper list which modifies the background screen colour, and then hands back the resources it used and quits. ■

## JUST SOME OF THAT CODE!!!

```
/* ***** GENERAL CONSTANT DEFINITION STATEMENTS ***** */
#define INTUITION_VERSION 0 /* Zeros mean ANY library versions */
#define GRAPHICS_VERSION 0
#define SCREENPLANES 4 /* Here we prepare to set up a high */
#define SCREENWIDTH 640 /* resolution Non-Interlaced screen */
#define SCREENHEIGHT 240 /* with 240 lines and 4 bitplanes */

/* ***** INCLUDE FILES ***** */
#include <exec/types.h>
#include <exec/memory.h>
#include <intuition/intuition.h>
#include <graphics/gfxmacros.h>
#include <graphics/copper.h>
#include <hardware/custom.h>

/* ***** STRUCTURES FOR SCREEN AND WINDOW ***** */
struct NewScreen NewScreen = {
0,0, /* top left */
SCREENWIDTH,SCREENHEIGHT, /* width and height */
SCREENPLANES, /* depth, i.e. the number of bitplanes */
1,0, /* detail and block pens */
HRES, /* ViewModes */
CUSTOMSCREEN,
NULL, /* Accept Default Font */
NULL, /* No Title */
NULL, /* No Gadgets */
NULL, /* Pointer to the bitmap structure */
};

struct NewWindow NewWindow = {
0,0, /* window XY origin relative to TopLeft of screen */
SCREENWIDTH,SCREENHEIGHT, /* window width and height */
-1,-1, /* detail and block pens same as screen */
NULL, /* IDCMP flags */
BORDERLESS, /* other window flags */
NULL, /* first gadget in gadget list */
NULL, /* custom CHECKMARK imagery */
NULL, /* window title */
NULL, /* custom screen */
NULL, /* custom bitmap */
SCREENWIDTH,SCREENHEIGHT, /* minimum width and height */
SCREENWIDTH,SCREENHEIGHT, /* maximum width and height */
CUSTOMSCREEN /* destination screen type */
};

/* allocate and initialize some memory for a user copper list. I'll
assume, for this example, that the allocation won't fail... */
c=AllocMem(12L,MEMF_CHIP|MEMF_PUBLIC|MEMF_CLEAR); CINIT(c,800L);

/* here's the loop which sets up the user copper list... */
for (j=0;j<SCREENHEIGHT;j++)
{
(j/15) % 2 ? Blue- : Blue++;
CWAIT(c,j,0L);
CMOVE(c,custom.color[0],Blue);
}

CEND(c); global_viewport_p->UCopIns=c;

/* we now redo the display so the copper list comes into effect... */
MakeScreen(global_screen_p); RethinkDisplay();

/* finally we quit after a delay of about 5 seconds */
Delay(250);
end_block();

exit(TRUE); /* Logical end of the program */
```

# YOUR ONE STOP SHOP

**MORE SOFTWARE THAN YOU CAN HANDLE!  
MORE HARDWARE THAN YOU CAN USE!**

# Software

**SUPERSTORE**

## AMIGA 512K MEMORY EXPANSION

- \* Brings your Amiga up to 1 Meg in seconds.
- \* Enable/disable switch. Now you can run ALL software.
- \* Easy to fit - no technical knowledge or tools needed.
- \* Reliable, fast, high quality chips on a robust through plated P.C.B. Do not confuse with cheaper, inferior products.
- \* DOES NOT INVALIDATE GUARANTEE.

**ONLY £49.99** +£2 Postage  
OR  
**ONLY £59.99** +£2 Postage  
WITH CLOCK/CALENDAR



## AMIGA Business Pack

- AMIGA A500 + Ram upgrade - gives -
- 1 Meg of Memory - Essential for business
- Modulator - Mouse - PSU - Manuals & Disks - Plus All Leads
- 10 Blank Disks & Disk Box (holds 40)

### Business Software Pack

#### Includes:-

- ✓ Deluxe Paint II
- ✓ KindWords 2.0
- ✓ Superbase Personal II

Only **£499.99**



The ORIGINAL from Commodore R.R.P. **£149.99**

WE STOCK MOST **DATTEL** PRODUCTS

## AMIGA 1010

EXTERNAL 3.5" DISK DRIVE

Why pay more for imitations when the real thing is this price?

now **Only £59.99**  
+£3 Postage

**Only while stocks last**

New!!

## AMIGA MEGAPACK

The **1 Meg AMIGA** pack  
Exclusive to *Software Superstores*

A500 + RAM Upgrade .....	R.R.P. £479.98
TV MODULATOR.....	24.99
• BATMAN(THE MOVIE).....	24.99
• NEW ZEALAND STORY.....	24.99
• DELUXE PAINT II.....	49.99
• INTERCEPTOR.....	29.99
Galaxy Force .....	24.99
Fighting Soccer .....	24.99
SUPER WONDER BOY .....	24.99
DYNAMITE DUX .....	24.99
ALTERED BEAST .....	24.99
Blasteroids .....	19.99
TEN STAR PACK .....	229.50
Computer care kit .....	7.99
10 Blank disks .....	9.99
Lockable disk box (40) .....	9.99
Quickjoy II Joystick .....	8.99
Carriage .....	<b>FREE</b>
TOTAL R.R.P.....	<b>£1046.33</b>

**OUR PRICE £499.99**

Items marked \* are in the BATPACK. The new FLIGHT of FANTASY pack is also available for the same price.

EVERYTHING you could possibly need for your **AMIGA**

### Blank Disks

We sell only the highest quality blank disks 100% certified and made in Japan. Each disk is guaranteed for life.

**Sony Branded**  
Box 10 ..... **£14.99**  
With FREE Disk Box (40)  
**Unbranded**  
**BULK PRICES**  
50 ..... **£29.99**  
100 ..... **£57.99**  
200 ..... **£99.99**  
Add £2 postage per order

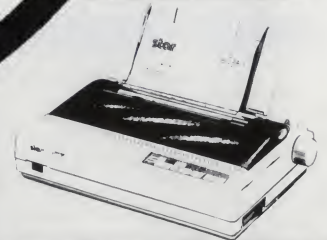

## CUMANA AMIGA DRIVES

the BEST NAME in Disk Drives

- Legendary Quality
  - Great Styling
  - Total Compatibility
  - Fully Guaranteed
  - Outstanding Spec
- NOW Only **£69.99**  
Carriage & insurance £2.00

## PRINTERS

All Printers Carriage FREE  
**star LC10**  
"Best Buy" budget printer.  
Only **£169.99**  
**star LC10 Colour**  
Only **£219.99**  
**star LC24 - 10**  
Only **£259.99**

**MAIL ORDER:- HOTLINE (0782) 204639 OR FAX (0782) 202269**

Carriage: All goods sent by post. Or add £5 per major item for next working day Courier service  
**POST** to Unit 7a Oldham St, Hanley, STOKE on TRENT, ST1 3EY Callers welcome at our shops

**STOKE-ON-TRENT**  
11 Market Square Arcade,  
Hanley, Stoke-on-Trent  
Manager: Adrian  
Tel: 0782 268620  
Open 6 Days

**SHEFFIELD**  
6 Waingate, Sheffield  
Manager: Tony  
Tel: 0742 721906  
Open 6 days

**ST HELENS**  
27 Baldwin Street,  
St Helens  
Manager: Adrian  
Tel: 0744 27941  
Closed Thursday

**STOCKPORT**  
6 Mealhouse Brow,  
(Off Little Underbank),  
Stockport. Manager: Ray  
Tel: 061 480 2693  
Closed Thursday

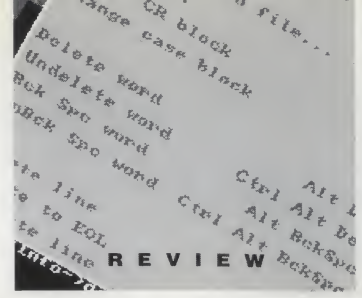

Programming is a funny old game. Sometimes you can produce reams of code and solve all those programming problems in no time at all, other times you can sit for hours without producing a single bit of useful code – a case of programmer's block, perhaps?

One of the factors that dictates how well you work is the quality of your working environment – if you don't feel comfortable when you're working, you just aren't going to be working at your full potential.

Disregarding the quality of your surroundings (is your chair comfy enough?), the programming tools you use can also have an effect on your working capacity. It's all very well going out and buying the most powerful and easy to use compilers available, but many programmers seem to ignore the most important programming tool of them all – the text editor. After all, the vast majority of your programming time will be spent writing code, so it's vital that your text editor is as unobtrusive to the creative flow as is possible.

### Pedigree Choice

Since its release nearly two years ago, Cygnus Soft's *Cygnus Ed* has caused something of a storm on the Amiga. Big names such as R J Mical and Jay Miner (two members of the original Amiga development team) have endorsed the product wholeheartedly. Indeed, many said it couldn't be bettered, but CygnusSoft have proved us all wrong with the release of *Cygnus Ed 2*.

From first impressions, *Cygnus Ed 2* looks virtually identical to its predecessor. However, further examination reveals both new and revamped features. Although the user interface hasn't changed noticeably, Cygnus have (surprisingly) changed many of the requesters. In particular, the *Cygnus Ed 2* file requester has been revamped beyond recognition – the original was something pretty special, but this new requester will just blow you away!

The strength of any text editor lies in the power and flexibility of its

features. The good news is that *Cygnus Ed* certainly isn't let down in this department. As well as all the usual features you'd expect from a top-flight text editor – such as the ability to copy, cut and paste blocks here, there and everywhere – *Cygnus Ed 2* offers many new features.

The original *Cygnus Ed* was renowned for its operational speed, but Version 2 raises the standard still further with an all-new turbo replace mode that operates up to 100 times faster than the original. Never again will you be left waiting for your text editor during an intensive search and replace operation.

*Cygnus Ed 2* will now maintain a command and change history for each file being edited. By simply allocating enough memory to this task, it is actually possible to undo and then redo every operation carried out during an entire editing session!

Bored with the standard Topaz font? With *Cygnus Ed 2*, you can change the screen font to any non-proportional disk or ROM-based font.

Macros are handy little fellows when you want to carry out the same series of operations several times without having to manually repeat every operation yourself. *Cygnus Ed 2* allows macros to be assigned to any key irrespective of the key's default value – you can even redefine the cursor and RETURN keys! This allows the entire keyboard to be remapped to the user's preference.

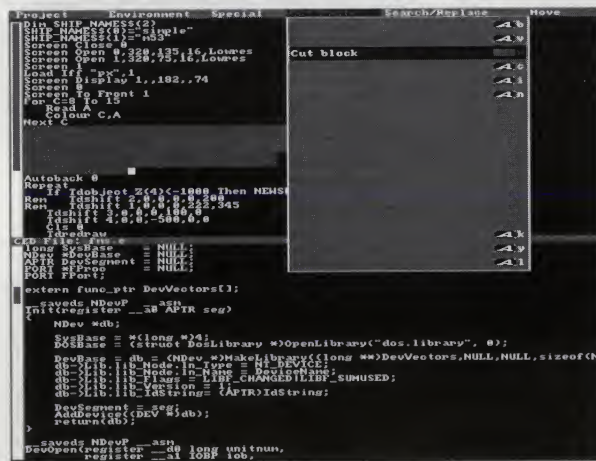

# CLOSE TO THE EDIT

Can Cygnus Soft's revised text editor live up to the reputation of its illustrious predecessor?

**JASON HOLBORN** finds out.

### Edit Decision

*Cygnus Ed 2* is simply breathtaking. The speed and smoothness at which it operates is both a staggering achievement in software design and a fine example of just how an Amiga application should be written – if only more Amiga products were implemented as well as *Cygnus Ed 2*! No other text editor on any machine even comes close to the power and smoothness of operation that *Cygnus Ed 2* provides. At the price, there is simply no excuse for not buying *Cygnus Ed 2*. If you're a programmer and you're serious about your profession, then you just cannot afford to ignore *Cygnus Ed 2*.

## REQUESTER MASTER

When you buy *Cygnus Ed 2* not only do you get a damned good, state-of-the-art text editor, but this latest release also includes a library of requester routines for programmers. This disk-based library includes many routines for creating and managing requesters and gadgets without having to suffer the hassle of using the Intuition library routines. Best news of all is that the library includes not one, not two, but three ready-made requesters to handle file I/O, colour palette editing and font selection.

Cygnus have generously decided to make this requester library freely distributable and are actively encouraging developers to use the library in an attempt to encourage a more standard user interface for the Amiga. Full documentation and 'Include' files for various languages are included on the *Cygnus Ed 2* distribution disk, therefore allowing everyone to take advantage of this marvellous library.

ABOVE: The *Cygnus Ed* user interface is a joy to behold. Both logically designed and fast in operation, it is a pleasure to use.

**CYGNUS ED 2**  
**£89.95 ■ All Amigas (1Mb advised)**  
**■ Silica Systems 081 309 1111**

RIGHT: Programmers will love the included requester library. It provides a whole host of gadget and requester routines and even three ready-made requesters covering file I/O, colour palette editing and font selection. Here's the file requester in action.

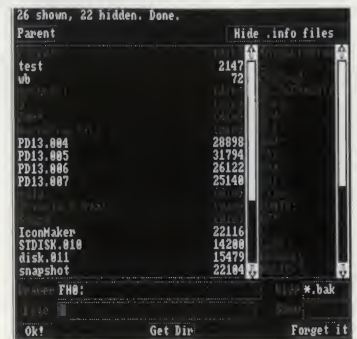

# HAMPSHIRE MICRO COMPUTERS LTD

Unit 11 Kingdom Close, Segensworth East,  
Hants PO15 5TJ

TEL: 0489 885911 FAX: 0489 885651

PRINTER PRICES INCLUDE CABLE & PAPER	PRICES SHOWN ARE EXCLUSIVE OF VAT	PRICES SUBJECT TO CHANGE
Citizen 120D £104	Hewlett Packard Deskjet Plus £585	Phillips 8833 Colour Monitor £204 + (£5 for lead)
Citizen Swift 24 £265	Hewlett Packard Deskjet Inkjet £490	Phillips 8833 Dust cover £6.00
Panasonic 1124 £229		Amiga 500 Batman Pack £312
Panasonic 1180 £139	LC10 & LC2410 Cut Sheet Feeder £51.30	Amiga 500 Flight of Fantasy £312
Star LC10 mono £129		Pro 5000 joystick £11.26
Star LC10 colour £169	PRINTER RIBBONS 120D original.....£4.00 LC10 colour.....£6.00 LC10 mono.....£4.00 LC241Q.....£5.00 Panasonic II24.....£8.65 Panasonic II80.....£8.65 HP Deskjet Cartridge£14.05 Epson LQ550.....£4.33 Epson LQ00/5.....£8.65	Amiga 500 Class of 90's Pack £460
Star LC24 10 £195		10 3.5 D/S D/D Discs £7.39
Star LC15 wide carr £260		3.5 x 100 Disk Box...£6.91 3.5 x 50 Disk Box.....£5.17 3.5 x 40 Disk Box.....£5.17
Epson LX400 £139		Cumana Drive £72
Epson LQ400 £215		
Epson LQ550 £283	Star LC10 Dust Cover £4.00	
Epson LX850 £181.74	Amiga 500 Dust Cover £4.00	
Hyundai HDP910 NLQ £165		
Integrex colour printer £540		

VISITORS WELCOME AT OUR SHOWROOM MON-FRI 9-5.30pm SATURDAY 9-1pm  
12 months guarantee. Phone for full price list  
SECURICOR DELIVERY: £7 + VAT. POST: £1 + VAT or £3

Do you get  
the best out  
of your Amiga

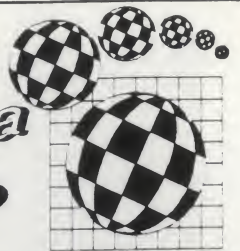

Amiga Amiga Amiga Amiga Amiga Amiga

The U.K. Amiga Users Group is the Largest Amiga only user group in the world. We are now in our fourth year and are the most established and experienced Amiga user group in the U.K. We have over 1,500 members and are able to offer an unrivalled level of support. Our members receive a 60+ page bi-monthly newsletter packed with articles of interest at all levels, we have a massive library of public domain software and run an Amiga only bulletin board. We offer our members superb discounts on all hardware, software and books. The U.K.A.U.G. is the group to belong to regardless of your age or level of experience, our aim being to provide support and encouragement to everyone. Why not join us and start to appreciate what Amiga computing is all about.

For more info,  
send a stamped  
addressed envelope  
or telephone...  
The U.K. Amiga User Group  
144 Charles Street  
LEICESTER LE1 1LB  
(0533)  
510066

## ★ ★ ★ SOFT EXCHANGE ★ ★ ★

£4.99 each or £12.99 for three

Joe Blade 1	Pac Boy	Growth
Joe Blade 2	Terrorpods	Vixen
War Machine	H.K.M	Cogan run
Hollywood Poker	Side Winder II	Echo
Starways	Return of Jedi	Bomjack
Space Battle	Hotshot	Trivia
Rocky	Adv Ski Sim	Navy Moves
Cruncher Factory	Drum Studio	Champ Football
Eye	Amegas	Kelly X
Thai Boxing	Captain Blood	Soldier Of Light
War Zone	Artificial Dreams	Las Vegas
Frostbyte	Demolition	Karting Grand
Artura	Grid Start	Prix
Challenger	HR 35	Invadars
Mousetrap	Seconds Out	Phalanx
IS Sphere	Dr Fruit	Speed
Thexder	Quasimodo	Mousetrap
Pool	Vader	Nebulus
Kickstart	Hellfire Attack	Protector
Alien Syndrome	Tracers	Hyperforce
Italia 90	Saint & Greavsie	Mindbreaker
SAS Combat	Final Trip	Atax
Treasure Island Dizzy	Fire Zone	Shooting Star
Eagles Nest	Road Wars	Atron 5000
Extensor	Emp. Strikes Back	Strange New
Fire Blaster	Fighter Mission	World
Ice Hockey	Gladiators	Road Blasters
Brainstorm	Rocky	
Quantos	Ebon Star	
Plutos	Beat it	
Space Station	Custodian	
Flight Path 737	Solitaire	
Jump Jet	Pacmania	
Space Flight	Fighting Soccer	
Espionage	Sky Fighter	

Shadow of  
the Beast  
with  
T-shirt  
£10.99

Prison.....	£6.99
Exolon.....	£6.99
Battle Valley.....	£6.99
Steel.....	£6.99
Cybernoid.....	£6.99
Slayer.....	£6.99
Zynaps.....	£6.99
Eye of Horus.....	£6.99
Gunship.....	£14.99
Elite.....	£13.99
Carrier Command.....	£14.99
Micro Soccer.....	£13.99
K. Spread.....	£24.99
K. Dat.....	£24.99
Kindwords 2.....	£24.99
Graphics Kit.....	£24.99
Kindword.....	£19.99
Maxiplan.....	£36.99

100% CERTIFIED  
ERROR FREE

10.....	£5.99
20.....	£10.99
30.....	£15.99
40.....	£18.99
50.....	£23.99
100.....	£49.99
Lockable Storage Boxes with 40 discs.....	£22.99
Lockable Storage Boxes with 80 discs.....	£44.99

### SERIOUS SOFTWARE

Cygnus Ed Pro.....	£64.99
City Desk V2.....	£139.99
Transcript.....	£30.99
Pagesetter 2.....	£77.99
The Works Platinum.....	£132.99
Excellence.....	£132.99
Pro Page 13.....	£193.99
Pro Page Templates.....	£38.99
Prog Page clip art.....	£38.99
Pagestream V1.8.....	£142.99
Pagestream Fonts 1-13.....	£27.99
Stream Postscript Fonts.....	£27.99
Superbase Personal.....	£43.99
Superbase Personal 2.....	£73.99
Superbase Professional.....	£186.99
Mail O Dex.....	£37.45
Publishers Choice.....	£67.99
Deluxe Paint 3.....	£59.99
Digipaint V3.....	£51.99
Photon Paint 2.....	£56.99
Prof Draw.....	£99.99
Modeller 3D.....	£56.99
Comic Setter.....	£37.99
A-Max Emulator.....	£83.99
Heraldic Pics.....	£26.99
Dragon Clip Art.....	£14.99
Starship 2050.....	£31.69

Home Accounts.....	£20.99
Maxiplan 500.....	£35.99
Protex V4.....	£65.99
Word Perfect 4.2.....	£165.99

### EDUCATIONAL

Mavis Beacon Typing.....	£25.99
Flight Simulator II.....	£29.99
Jet.....	£25.99
Super DJ.....	£18.99
Mr Paint.....	£29.99
World Atlas.....	£39.99
Scenery Disks for Flight Jet.....	£11.99
Deluxe Maps.....	£18.99
Distant Suns.....	£52.99
Fun Keys.....	£26.99
Life Cycles.....	£22.99
Talking Colouring Book.....	£22.99
Creature.....	£22.99
Trackers Quest.....	£22.99
Discover Chemistry.....	£14.99
Mastering CLI.....	£29.99
Software from Hell.....	£46.99
Designasaurus.....	£29.99
Descartes-Maths-Graphs..	£22.99

Full list of serious  
software available  
on request

081 653 9094

To avoid disappointment, please always include an alternative.  
All prices include VAT and delivery. Send Cheque/P.O. to:  
SOFT EXCHANGE, 101 CLIFTON ROAD, SOUTH NORWOOD, LONDON, SE25 6QA

081 653 9094

**W**hy go out into the countryside, with paints in your hand and canvas rolled up under one arm, just to paint a landscape when it's sure to take up the best part of a day? You have all the equipment in your own home, and the job can be done in a tenth of the time! With the good old box of microchips, plus some modern mathematics, you can create classic, picturesque masterpieces and store the scenes on disk.

*Scene Generator* enables you to create your very own landscape scenes with stunning results. The program creates random 'fractal' landscapes, and can create nearly infinite varieties too, enabling you to experiment to create the scene of your choice.

The landscapes range from simple foothills to tall mountain ranges, and as well as the main body of land, there are a limited number of other features that can be included, such as water, clouds, snow and beaches.

The whole idea is that *Scene Generator* produces natural scenes, so there is no option to include extra materials such as buildings, roads or any other commercialised activity.

### Mathematics

To determine the shape of the landscape you have to enter number values from the options in the menu, and these options must be variable. The basic shape of the landscape depends on the seed and height values of the land. Both values are integer numbers that are entered under the 'land' menu option. The seed may range from 0 to 65535 or can be randomised.

The land height is an integer in the range of 0 to 9999, so if you wanted to create a landscape of foothills, then you would enter a value of around 500, but if you decided on a new Mount Everest situated in a spiky mountain range then you'd enter a value of around 9000.

Because the scenes created have such wide variety and effect, many would assume that in order to create such scenes, they'd have to undergo a lifetime of instruction reading. But no – in this case, the instructions are short and very easy to understand.

Starting off is very simple and it does not take long to revise the options available and get used to creating what you want.

The more accustomed you become with what the integer numbers produce, the closer to perfecting an idea you get. This applies to the palette combination of greens, greys and browns as well, which is an option you get used to in creating the desired effect for a scene.

The few options available are all that's needed to create the best scenes and it's not always necessary to include all the options, as some

# SCREEN SCENE

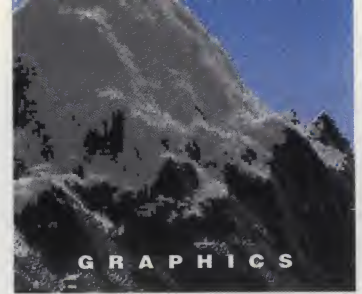

Art packages are appearing thick and fast these days, but some take a new approach. Take a fractal attitude to the natural world with **MARK HILL**.



**TOP:** The fractal scenes are saved in IFF format, so can be loaded into an art package and used as a background. Here a *DPaint* brush from *Real Things* is given a natural background.

**ABOVE:** *Scene Generator* allows great control over the palette after a scene's created, so effects like this sunset can be achieved.

scenes only need a small combination of features to get the best effect.

### Menus

Probably the most important menu and the one that's used first for the foundations of a new scene is the land menu. Here you choose the colour of the land by combining brown, grey, green tones and also white for snow, if you wish.

The other features available are simple items that provide the rest of

the ingredients for a particular scene. The 'lighting menu' determines where the light appears on a scene and you select one of nine possibilities. For example the light source can be overhead or at front left, all dependent on which option suits a particular scene.

On the water menu you can select whether you wish to include water, and if so, at which level. Included under the water menu heading is the option of adding texture and beaches to add that extra bit of detail to a developing creation.

The final options menu is where you can modify the palette from the standard set of colours used by *Scene Generator*. This option gives you great flexibility and enables you to achieve many different effects. The 32 colours available are divided into five groups. One set of four are for the sky, another four determine the water surface, and three groups of eight for the land. And what landscape would be complete without a few clouds, which can also be added.

A vital element that makes this program so appealing is the simplicity of the instructions in proportion to the effective detailed results – such little time is needed to create a really good scene. If you don't fancy ploughing through piles of instructions on most art programs but fancy creating a worthwhile scene that's detailed and interesting then check this out.

The graphics are superb and the scenes are very lifelike and incredibly detailed. It's an artistic package that shows originality and, by virtue of the fractal imaging, really puts the natural world into perspective.

**SCENE GENERATOR (PAL version)**  
All Amigas ■ \$49.95 ■ Natural  
Graphics, California 916 624 1436

# PHONE ANYTIME FOR FAST FRIENDLY SERVICE

## AMIGA A500 PACK

512K RAM Computer - Built-in 1Mb Disk Drive, Workbench 1.3, Mouse, A520 TV Modulator, Speech Synthesis, Deluxe Paint II Art Package, Basic 1.3 Disk, Extras and Tutorial Disks. All leads, three manuals and even a 13A plug!  
**£369.99**

**FREE F29 Retaliator, Rainbow Islands and Robot Monsters**

OR

**FREE Batman The Movie, New Zealand Story and Interpreter Flight Sim**

STATE WHICH FREE PACK REQUIRED

## ACCESSORIES VALUE PACK

Microswitched Joystick, Tailored Antistatic Dustcover, Mouse Mat, 10 Blank Disks, 40 Lockable Disk Box, Mouse Holder .....if purchased with Computer or with any order over £100 in value .....**£24.99**

## PRINTERS

Star LC10 .....**£155.99**  
Star LC10 Colour .....**£199.99**  
Panasonic KXP1124 24 Pin .....**£259.00**  
All complete with FREE Lead, Ribbon, Connecting Cable and Plug. UK Made.

## UPGRADES FOR 1.2 AMIGAS

ROM Version 1.3 Kickstart ROM with fitting instructions .....**£29.99**  
ENHANCER Consists of Workbench 1.3 and Extras 1.3 .....**£13.99**

## 1Mb - 3.5" DISK DRIVES

CUMANA CAX354 Disk Drive .....**£71.99**  
AMIGA A1010 Disk Drive .....**£69.99**  
A.C.S. Slimline, Switch and Thru Port (NEC or TEAC Drives) .....**£59.99**  
☆☆ **SPECIAL** ☆☆  
Amiga External Drive plus Shadow Of The Beast + Kick Off + RVF Honda + Battle Squadron .....**£169.99**

## HARD DISK DRIVES

AMIGA A590 20Mb Plug In Drive .....**£359.99**  
Upgrade Chips per Megabyte .....**£79.00**

## RAM EXPANSIONS

M.E.S. 512K RAM Expansion, Clock and Switch with FREE 1Mb Demo .....**£49.99**  
Amiga A501 - 512K RAM Expansion and Clock - Made by Commodore .....**£89.99**

## MIDI EQUIPMENT

DATEL Midi Master Interface .....**£29.99**  
Midi Leads ... per pair .....**£5.98**

## JOYSTICKS

KONIX Speedking .....**£9.99**  
KONIX Navigator .....**£9.99**  
ZIPSTICK Super Pro .....**£13.99**  
CHEETAH Mach 1 .....**£10.99**  
COMPETITION PRO GLO GREEN .....**£15.99**  
QUICKSHOT 2 Turbo .....**£8.99**  
QUICKJOY 125 Superboard .....**£18.99**  
QUICKJOY 126 Jet Fighter .....**£12.99**

## ACCESSORIES

AMIGA Keyboard Dust Cover .....**£1.99**  
AMIGA Monitor Dust Cover .....**£2.99**  
STAR Printer Dust Cover .....**£2.99**  
Quality Soft Mouse Mat .....**£2.99**  
Mouse Bracket (to hold mouse) .....**£1.99**  
3.5" Disk Drive Head Clean Kits .....**£3.99**  
PREMIER CONTROL CENTRE - Sits over Amiga as Monitor Stand & Second Disk Drive Holder .....**£45.99**  
MARCONI RB2 PC9 Trackball .....**£49.99**

**SUMMER SALE**

## DISKS - DISKS - DISKS

FULLY GUARANTEED DSSD BULK DISKS  
100% Certified-either SONY, TDK or MITSUBISHI  
Unbranded-all individually wrapped & with labels  
Pack of 20 .....**£9.99**  
Pack of 20 in our Top Quality Lockable 40 Disk Holder .....**£13.49**  
12 Flip Top Disk Holder .....**£0.89**  
40 Disk Holder Lockable Top Quality .....**£3.99**  
60 Disk Holder Lockable Top Quality .....**£5.99**  
*Spare Labels, asstd. colours 60 for £1.00*

## EDUCATIONAL & CHILDRENS

Fun School 2 - Under 6 .....**£12.49**  
Fun School 2 - 6-8 years .....**£12.49**  
Fun School 2 - 8 and over .....**£12.49**  
Micro English (GCSE) .....**£17.99**  
Micro Maths (GCSE) .....**£17.99**  
Things to do with Numbers .....**£15.99**  
Things to do with Words .....**£3.99**  
AB Zoo .....**£14.79**  
Spell Book 4-6 or 7+ .....**£39.99**  
Amiga Logo .....**£18.49**  
Mavis Beacon Teaches Typing .....**£18.49**

## SERIOUS SOFTWARE

Kind Words V2.0 .....**£30.99**  
Scribble Platinum .....**£33.99**  
Pen Pal .....**£94.99**  
Protext V4.2 .....**£64.99**  
Superbase Personal .....**£39.99**  
Superbase Personal 2 .....**£64.99**  
K-Spread 2 .....**£37.99**  
Digicall .....**£24.49**  
The Works - Platinum Edition .....**£109.99**  
Home Accounts .....**£19.99**  
Digits System 3 .....**£31.99**  
Personal Accounts Plus .....**£21.99**  
Small Business Accounts .....**£55.99**  
Small Business Accounts Extra .....**£79.99**  
Personal Tax Planner .....**£25.99**  
Page Setter V2 .....**£69.99**  
Publishers Choice .....**£65.99**  
Starter Kit .....**£45.99**  
Home Office Kit .....**£94.99**  
Asssem Pro .....**£51.99**  
HiSoft Basic .....**£55.99**  
HiSoft Basic Extend .....**£14.95**  
Lattice C v5.0 .....**£159.99**  
AMOS the Game Creator .....**£33.99**  
Trip-A-Tron .....**£19.99**  
Deluxe Paint III .....**£55.99**  
Deluxe Paint II .....**£29.99**  
Deluxe Video III .....**£55.99**  
Spritz High Quality Paint Pack .....**£29.95**  
Movie Setter .....**£39.99**  
Comic Setter .....**£29.99**  
Deluxe Music Construction Set .....**£47.99**  
Dr T's Midi Recording Studio .....**£38.99**  
DOS 2 DOS .....**£26.99**

THESE SPECIAL PRICES ARE MAIL ORDER ONLY AND VALID UNTIL AUG 10TH. IF SHOPPING PERSONALLY BRING THIS AD WITH YOU OR REFER TO IT IF TELEPHONING YOUR ORDER.

## LEISURE SOFTWARE

Cartoon Capers .....**£12.99**  
Castle Master .....**£16.25**  
Combo Racer .....**£16.49**  
Damocles .....**£16.25**  
Dragon Force .....**£19.99**  
Emlyn Hughes Int Soccer .....**£16.25**  
Escape From Planet of Robot Monsters .....**£12.99**  
Everton FC Intelligentsia .....**£12.99**  
F19 Stealth Fighter .....**£19.49**  
F29 Retaliator .....**£16.25**  
Fire & Brimstone .....**£16.25**  
Flimbo's Quest .....**£16.25**  
Football Manager World Cup Ed .....**£12.99**  
Gravity .....**£16.25**  
Hardball 2 .....**£16.25**  
Harley Davidson .....**£19.49**  
Heroes Quest .....**£22.79**  
International 3D Tennis .....**£16.49**  
Italy 1990 .....**£16.25**  
Kick Off Extra Time .....**£6.99**  
Kick Off 2 World Cup 90 .....**£16.25**  
Lost Patrol .....**£16.25**  
Manchester United .....**£16.25**  
Manhunter San Francisco .....**£19.49**  
Midwinter .....**£16.25**  
Necronom .....**£16.25**  
Powerboat Simulator .....**£16.25**  
Resolution 101 .....**£16.25**  
Retex .....**£24.99**  
Shadow Warrior .....**£16.25**  
Sir Fred .....**£19.49**  
Sword of Aragon .....**£19.99**  
Their Finest Hour .....**£19.99**  
Theme Park Mystery .....**£16.25**  
Tower of Babel .....**£16.25**  
Toyotots .....**£12.75**  
Turricane .....**£12.75**  
Ultima V .....**£19.50**  
Ultimate Military Simulator .....**£16.25**  
Venus Fly Trap .....**£12.99**

PLEASE ASK FOR DETAILS OF ANY GAME NOT LISTED

## AMIGA BOOK SPECIALS

Advanced Amiga Basic .....**£16.49**  
3D Graphics Programming in Basic .....**£16.99**  
Amiga Applications .....**£14.49**  
Amiga Assembly Language Program .....**£11.49**  
Amiga Basic - Inside and Out .....**£17.99**  
Amiga C for Beginners .....**£14.49**  
Amiga C for Advanced Programmers .....**£27.99**  
Amiga Disk Drives - Inside and Out .....**£24.99**  
Amiga DOS - A Dab Hand Guide .....**£13.99**  
Amiga DOS - Inside & Out .....**£16.49**  
Amiga DOS Quick Reference Guide .....**£8.99**  
Amiga DOS Reference Guide 3rd Ed .....**£14.49**  
Amiga for Beginners .....**£11.99**  
Amiga DOS Manual .....**£21.99**  
Amiga Graphics Inside & Out .....**£25.99**  
Amiga Handbook .....**£15.49**  
Amiga Hardware Reference Manual .....**£20.99**  
Amiga Machine Language .....**£12.49**  
Amiga Machine Language Guide .....**£17.49**  
Amiga Programmers Handbook .....**£22.99**

**SUMMER SALE**

Amiga Programmers Handbook vol2 .....**£22.99**  
Amiga ROM Kernel Libraries & Devs .....**£27.99**  
Amiga System Programmers Guide .....**£28.99**  
Amiga Advanced Systems Prog Guide .....**£25.49**  
Amiga Tricks and Tips .....**£13.99**  
Amiga More Tricks and Tips .....**£16.49**  
Computes First Book Of The Amiga .....**£13.99**  
Computes Amiga Programmers Guide .....**£15.99**  
Beginners Guide to the Amiga .....**£13.99**  
Elementary Amiga Basic .....**£12.49**  
Inside Amiga Graphics .....**£14.49**  
Kids and the Amiga-Kids 8 to 80 .....**£13.49**  
Programmers Guide to the Amiga .....**£22.49**  
Using Deluxe Paint 2nd Edition .....**£17.49**  
Amiga Desktop Video Guide .....**£15.99**  
Kickstart Guide to the Amiga .....**£13.99**  
Learning C - Programming Graphics .....**£16.99**  
Inside the Amiga with C .....**£18.99**  
Becoming An Amiga Artist .....**£15.99**  
First Book of the Amiga .....**£14.49**  
Amiga Users Guide to Graphics, Sound & Telecommunications .....**£16.49**

## AUDITION COMPACT SERVICES,

9A St. Peters Street, Stamford, Lincs, PE9 2PQ.

Send Cheque or phone Credit Card Details for same day despatch or come and browse in the shop  
**Telephone 0780 55888 Shop Hours - 0780 720531 Out of Hours.**



**APL.68000** brings the right mix of power + sophistication for your Amiga. In fact APL.68000 is one of the few applications that can make full use of your machine's memory.

**THE APL** programming language is widely used by many of the world's largest corporations to solve their more ambitious computing problems - why not use it for yours?

## APL.68000 - THE LANGUAGE

- Unique array handling language
- Fast program development
- Full 15 digit accuracy
- One of the most powerful languages on the Amiga

APL. 68000 costs: **£99.95** (Inc VAT) - Basic version

**£299.95** with 68881/68882 Support + Faster Libraries

All supplied with a comprehensive manual, reference card and keyboard stickers.

P+P £3 (Inc VAT) To order contact:

MicroAPL Ltd  
South Bank Technopark  
London Road  
London SE1 6LN  
071-922 8866



# EDUCATION

We Have Over 50 Top Class Educational Programs For The Amiga & Atari ST

## Mathtalk

This talking Maths Tutor is probably the best program available today to teach and

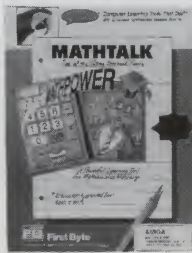

test addition, subtraction, multiplication & division

Ages 5+  
£29.95

## Kidtalk

This amazing talking word processor is an ideal & fun way to introduce children to the

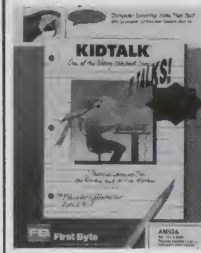

more serious side of using a computer.

Ages 5+  
£29.95

**SPECIAL OFFER** Fun School 2 £12.75 - Limited Offer.

Contact us now for our latest catalogue which contains details of all the very best educational programs available today.

**ESP EDUCATIONAL SOFTWARE**  
32B Southchurch Road, Southend-on-sea, Essex SS1 2ND.

**(0702) 600557**

Out of Office Hours Answer Phone  
FAX 0702 613747  
School Enquires Welcome

# THE WHOLE TRUTH ABOUT games programming PART 7

## The Guardian

Here it is – the last instalment of *Menace, the game!* This month's source contains the addition of the guardian graphics and code.



The guardian is simply made up of a few normal aliens, as described last month. It is not normally feasible to have a huge animated end guardian as it would require vast amounts of memory. The usual sacrifice is to have the main bulk of the guardian as a single bitmap, with bobs or sprites overlayed on top for the animating sections.

The classic *R-Type* did this in the end of Level One guardian where only the tail and a small part of the stomach were actually animated, but it was still pretty impressive. *Menace* is not that impressive, but it does demonstrate the usual technique.

### Big Bad Boys

The pictures above and right show the guardians from Levels One and Five respectively. These are the *DPaint* screens. All guardians are 256 x 192 pixels in size. They are drawn on the right-hand edge of the screen in strips of 16 pixels, just as the map was. Rather than store them as a simple bitmap image (3 planes x 192 high x 32 bytes wide = 18432 bytes) a simple compression was used in order to save memory.

Each strip of 16 pixels was compressed by noting where all the zero words occurred and only storing the actual non-zero data. This was done by looking at the words from

each plane of the image in succession from the top of a strip down to the bottom. If all three planes held no data (this happens a lot, as you can see from the figures) a single bit

data to the compressed file, and will have 192 bits of data (24 bytes) to signify which line of the bitmap this particular data came from. This is a very simple but relatively quick compression method (known as a

“Then the ‘death’ path is initiated which ensures nobody takes a leisurely attitude when dealing with the guardian!”

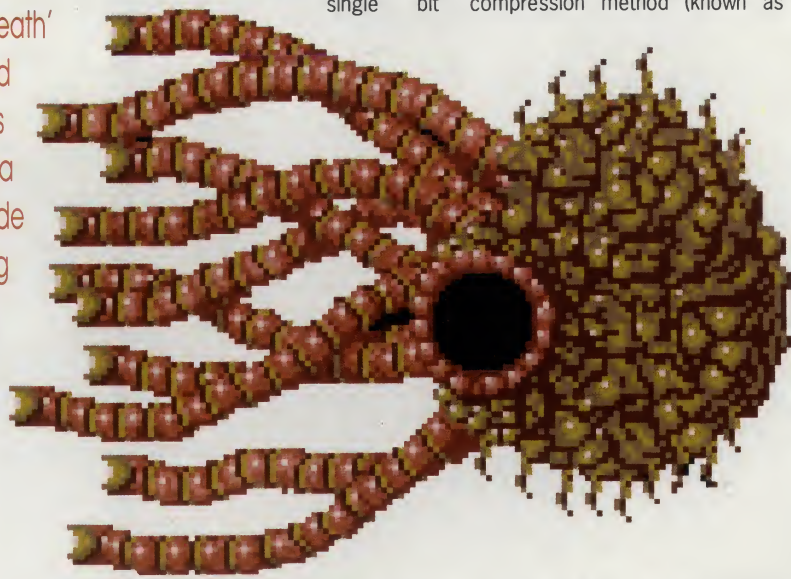

was stored to flag this, and no data was stored in the compressed file.

If any of the planes did contain data then this was flagged by a single bit, and the three words of data were copied to the compressed file. At the end of the strip (192 lines high) we will have only copied the non-zero

‘bitmap header’, as we produce a map of bits to represent the data). It usually halves the size of the guardian data for each level.

### Eye Holes

You can see in the picture above the ‘hole’ for the eye in the Level One guardian. The eye is simply a normal





alien following a standard path. The game knows when a level has been completed when this alien is destroyed. All aliens have a unique number so this is very easy to check.

The guardian bitmap image is drawn in the front playfield so all the aliens appear behind the image as with the foreground scenery. This allows aliens to 'appear' anywhere on the screen, but as long as they are behind the guardian it will not be noticeable. This is how the small 'tadpoles' on the Level One guardian are repeated. Their path data simply makes them appear under one of the guardian tentacles, then swim left till they are offscreen, then go back to the tentacle; and so on. Nice and simple, but it works.

The guardian path is repeated for about 30 seconds, which should be enough time to kill the guardian. If it has not been killed in this time then the 'death' path is initiated in which case all the aliens are substituted for homing mines that cannot be destroyed. This ensures nobody takes a leisurely attitude when dealing with the guardian!

#### Death by Explosion

When you finally kill the guardian another alien path is started. This one, though, is not deadly, but is simply a collection of explosions all around the guardian body to give the effect of it exploding. This is no different from any other path data and shows that a flexible routine can be used in many places in a game, saving the task of writing more code for some effects.

And that is basically all the game ingredients covered. I have not presented the code for the 'extras' that go into a game as many are quite simple and others have been the result of many months' work and cannot be published, but I'll run over some of the main ones.

#### Disk Routines

Hmmm, the main reason for many sleepless nights for Amiga programmers! There are three basic levels to using the disk drives on the Amiga for reading/writing your data. AmigaDOS is by far the simplest, and is frequently used for development tools.

To use the DOS routines for a game requires that the operating system is fully intact. This causes severe performance and memory loss. The performance loss can be solved by using the framework given in the first article to disable then re-enable the system when you wish to use a DOS routine.

The memory loss due to the operating system, though, cannot be solved. You will typically lose 100 KBytes if you want to use DOS. This is a lot of memory to a programmer so the DOS route is not usually taken.

The trackdisk device is a set of Amiga system routines that allow you to access the disk as individual sectors. It is quite fast and can run with the minimum of the operating system being intact. Memory loss is still a problem, though, at around 50 KBytes, and once again you have to enable the system to use the trackdisk routines. Providing you can work with this it is a useable alternative to the real hardware nitty gritty.

Getting right down to hardware register level is the lowest we can go. Come down to this level and you have complete control of the system and ALL the memory. Be warned though, MFM encoding, Precomp, SYNC words etc. are all tricky issues. In their individual ways they are quite straightforward, but the difficulty is in testing them all together.

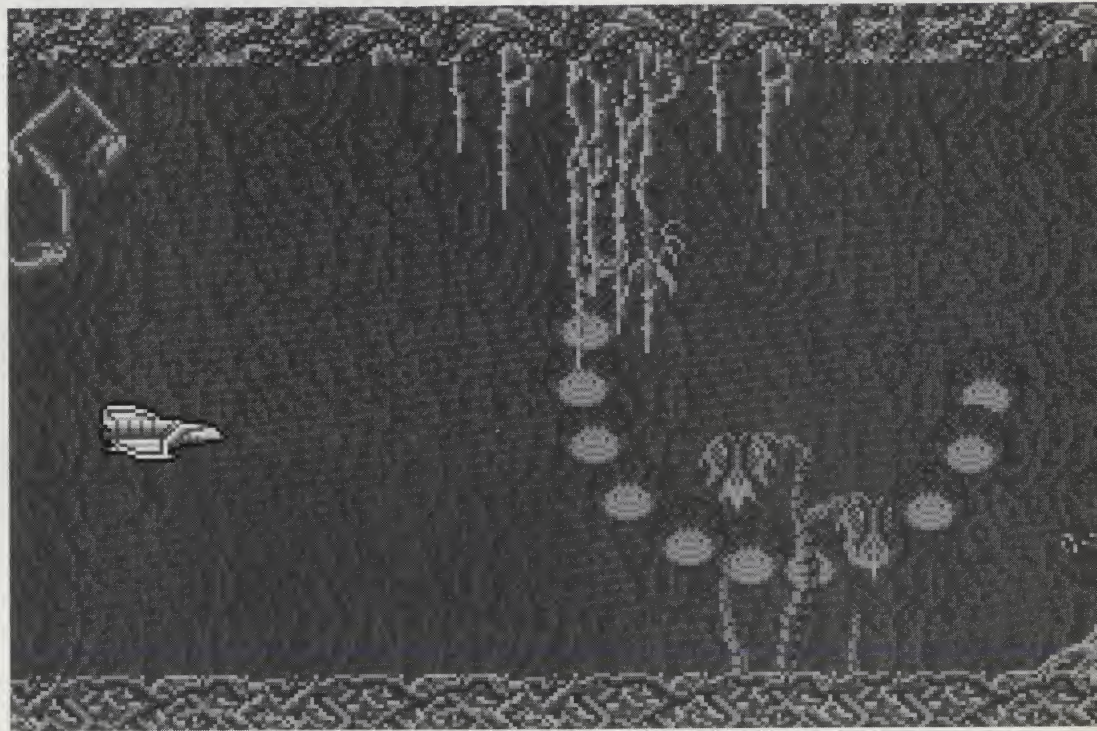

You cannot use a monitor such as Monam2 to debug, as this would require the system to be running, which would interfere with the code you are trying to test. The ideal situation is remote debugging (connecting two Amigas via the parallel port, as Devpac Professional allows) but this is quite expensive.

The method I used when first writing the disk routines was simple trial and error and many late nights. Luckily they only have to be written once. Once they are working simple refinements are all that is required. The Abacus book 'Amiga Disk Drives Inside and Out' has recently appeared on the market, which should prove to be a big help.

This is the only method to use if you want the full memory and complete control so it is well worth spending time writing some *reliable* disk routines for your game.

“a flexible routine can be used in many places in a game, saving the task of writing more code for some effects”

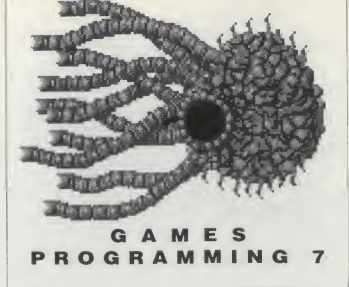

#### Music And Sound Effects

The music and sound effects for *Menace* were written by Dave Whittaker. His name is fairly well known for Amiga game music (other titles include *Shadow Of The Beast* and *Xenon II*). The ideal situation is to get the music written by someone like Dave, who does this for a living.

At the end of the day what you get for your money is the music and sound effects, for basically any machine you require, along with the code to play them, all supplied in a single module of data.

You simply call one of his routines from within your code, and off goes the music or sound effects etc. This makes life very simple for the game programmer, the music and effects usually only taking one day to be added to the game.

The Amiga, though, is well catered for in the music department. You may decide to write the music yourself with one of the standard packages such as *SoundTracker* or *SoundFX*. These popular programs have source code available to play the music that you create. You can therefore save some money by having a friend with a little musical ability, compose a track on one of these packages, then spend a little time on getting the player working in your own code.

These packages do not, however, cater for the playing of sound effects over the top of the music. A simple

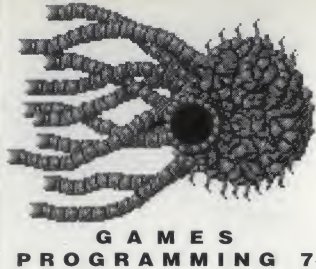

**GAMES PROGRAMMING 7**

sample player is all that is really required to generate some effects, so the simple solution is to allow the game to have music or sound effects going, but maybe not both at once.

The main minus point about using a standard Amiga package is simply one of portability of the music. If, for instance, an ST version of the game is required then ideally the music writer and player you use on the Amiga should also be available on the ST. I believe that there is now a *SoundTracker* file player for the ST, so if you use that program this would solve your portability problem.

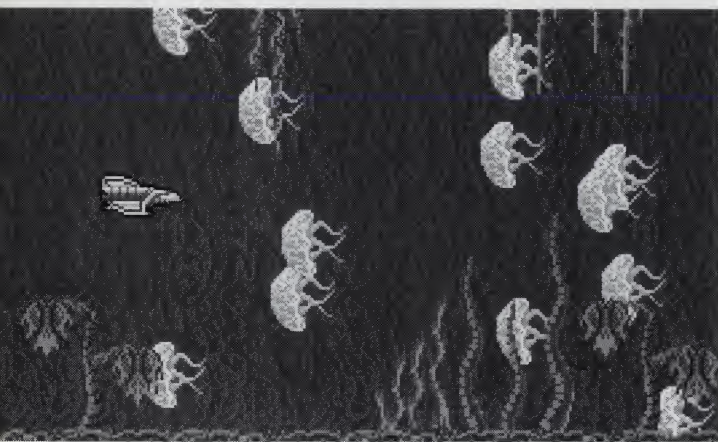

Memory wise, you should leave aside about 100 Kbytes for a decent soundtrack. It is possible to have a soundtrack that does not use samples, but generated instruments as used on the C64. Soundtracks that use this technique will quite easily fit within 10 Kbytes, but you obviously lose a little of the effect of good Amiga samples.

One point to bear in mind on the music front is one of playback speed. Most of the player routines are patched into the vertical blank routine, so on PAL machines the music is updated 50 times per second. This seems fine, but remember that the NTSC standard, as used in the States, updates 60 times per second. This means that the music will be 20% faster over there than over here. This can turn a good soundtrack into one that sounds a bit naff because it is too fast.

Your game should either use a timer to generate a 1/50th of a second interrupt, which will be the same on any machine, or detect which type of machine you are on (PAL/NTSC) and slow down the music accordingly. This is simply done by not calling the music routine every 6th vertical blank on an NTSC machine. Remember also that you have 20% LESS processor

“Games like *Populous* and *Stunt Car Racer* really come into their own in head-to-head mode – they have cost us many a day’s work!”

time per frame on an NTSC machine. This can cause havoc if you write a game, designed to run in a single frame, that has not taken into account this loss of processor time.

All new Amigas with the fatter AGNUS chips now have the capability to be switched into 60 Hz mode. Monitors (and some TVs) can handle this, and ideally you should try to get access to one to test out your code on in 60 Hz mode. All Amiga games should also now start to accommodate this 60 Hz switch capability on a key press in a game.

Running your game in 60 Hz mode will result in the game playing 20% faster, and also filling the entire PAL display (even though the graphics may look a little stretched). ST owners have always had this capability, and it is a nice feature to include into a game.

**Intro Sequence**

A nice rolling intro for the game can do wonders for its appeal. They add nothing to the game, but add a little variety to the package. A good intro to a game should be a piece of code that is technically and visually excellent, the sort of thing that is not really possible to implement in a game itself, but shows of some of the capabilities of the Amiga.

This sort of effect should also be added to the game should anyone eventually complete the game. It is a real letdown when you spend months playing a game, finally manage to finish it, and up pops a bit of text saying ‘Well Done!’ Programmers who do this should be shot (there is an animated sequence at the end of *Menace* and one after *Blood Money*, by the way, so I’m safe from the assassins for now!)

**AND FINALLY ...**

**TEXT ROUTINE**

Try to design an impressive character set, maybe incorporating some copper tricks to jazz the text screens up a bit. If you are working on a monitor then keep in mind the TV users and don’t have a small character set, they will probably not be able read it.

**HIGH SCORE TABLE**

Most arcade style games need a high score table. They are usually pretty boring to write (this is usually the first routine to get delegated to new programmers!) A ‘save to disk’ option is usually a must.

**DEMO MODE**

Any game that has a self-play demo mode is much more likely to be loaded and displayed in a shop. It will also help when the game is shown at the multitude of computer shows throughout the year.

**SERIAL/PARALLEL LINK**

Many games are now incorporating these types of link for head-to-head action. Games like *Populous* and *Stunt Car Racer* really come into their own in this mode – they have cost us many a day’s work! It really depends on if the game is suited to a two-player head-to-head, of course, shoot-em-ups generally are not, but there is always a first time for everything...

**PROTECTION**

Most programmers tend to implement various protection schemes of their own, although the disk duplicators can often offer their own techniques also. In my belief it is not possible to protect a disk 100% from being copied. The main aim is to DELAY as much as possible the inevitable ‘cracked’ copy appearing.

Most games tend to sell their strongest in the first month. Over a period of two years, 80% of the sales may well have happened in this first month. If you can therefore stall the pirates for as long as possible, people have a much better chance of seeing the game in their local shop, than suddenly appearing in the post from friends.

Adding protection can be a long and tiresome process. It is sad that it has to be done, but that is a topic we are all familiar with...

On that sombre note I’ll wrap up this series. I hope many of you have a go at some programming. It is possible to write games in your spare time as a hobby. You never know, it could lead to a full-time job. And as the old saying goes, “A man whose hobby is his job, is a very happy man” (circa. 1990 Dave Jones, DMA Design).

# INTERFACE SOFTWARE

## DOWN TO EARTH PRICES

**520 ST POWER PACK**  
ATARI

INC: 512K RAM, Internal Power Supply, built in 1Mb disc drive, built in T.V. Modulator, Mouse, Joystick  
**20 BEST SELLING SOFTWARE TITLES SUCH AS:** Outrun, Xenon, Predator and much more. Plus ST Basic Music Maker, Organiser (inc Database/Spreadsheet)

**£399 inc VAT**  
+ FREE  
INTERFACE  
MEGAPACK 1 or 2  
(worth over £100)

**ALL PRICES  
INCLUDE V.A.T.**

**FLIGHT OF FANTASY**  
AMIGA

INC: 512K RAM, 1Mb Disc Drive, Mouse, T.V. Modulator, Workbench Software, Basic language Disc, F99 Retaliator, Rainbow Islands, Escape From The Planet Of The Robot Monsters

**£399 inc VAT**  
+ FREE  
INTERFACE  
MEGAPACK 1 or 2  
(worth over £100)

**PC STARTER PACKS**

(As seen on T.V.)  
(inc 12 months on site maintenance contract)

PRICES FROM  
**£599 inc VAT**  
PC 10 SD MONO

**BATMAN PACK**  
AMIGA

INC: 512K RAM, 1 Mb disc drive, Mouse, T.V. Modulator, Workbench Software, Basic language Disc  
Deluxe Paint II, Batman The Movie, New Zealand Story, Interceptor

**£399 inc VAT**  
+ FREE  
INTERFACE  
MEGAPACK 1 or 2  
(worth over £100)

**DISCOVERY PACK**  
ATARI

INC: 512K RAM, Internal Power Supply, built in 1Mb Disc Drive, built in T.V. Modulator, Mouse. PLUS First Basic, Neo Chrome Art Package, S.T.O.S. ST Tour, Carrier Command, Outrun, Space Harrier, Bombjack

**£299 inc VAT**  
+ FREE  
INTERFACE  
MEGAPACK 1 or 2  
(worth over £100)

**CLASS OF THE 90'S**  
AMIGA

INC: Midi Interface + Software, Word Processor, DTP program Superbase, Spreadsheet, Amiga Logo, BBC Emulator, Deluxe Paint II  
+ FREE INTERFACE, MEGAPACK 1 or 2 (worth over £100)

Ring For Details



**MEGA PACK 1**

CONTAINS:  
10 Blank Discs  
Disc Storage Box  
Dust Cover  
Mouse Mat  
Joystick  
5 Mystery Games

**MEGA PACK 2**

CONTAINS:  
5 Blank Discs  
Disc Storage Box  
Dust Cover  
Mouse Mat  
Joystick  
5 Mystery Games

**BUY 1 GET 1 FREE!**

For a limited period only, when you buy any ST/Amiga/PC game, at the normal price, we will supply a mystery game absolutely FREE!

**PRINTERS**

Star	.....
LC10	.....169
LC10 Col	.....209
LC24-10	.....249
Citizen - 24	.....299

**MONITORS**

Philips 8833	.....249
Commodore 1084	.....249
Atari SM128	.....

**DISK DRIVES**

Atari	.....
Cumana	.....99
CSA	.....354
Power Drive	.....89
Amiga	.....
Cumana	.....95
Cax 354	.....
Action Soft	.....89

**TO ORDER:**  
By Phone:- CALL OUR SALES TEAM NOW! ON  
**061 - 431 - 4091**  
Write To:- **INTERFACE SOFTWARE, PO Box 100, STOCKPORT, CHESHIRE SK4 2DP**

**DELIVERY** - FREE Postal Delivery, Courier Service Available (add £5)  
**WARRANTY** - Full 12 month warranty on all hardware.  
(All equipment tested prior to despatch)  
**TECHNICAL SUPPORT** - Any problems, phone **061 431 4091**

All offers subject to availability. Interface reserves the right to change, or withdraw any offer without prior notice.

CUT OUT AND POST TO ABOVE ADDRESS FOR FREE CATALOGUE

NAME \_\_\_\_\_  
ADDRESS \_\_\_\_\_  
POSTCODE \_\_\_\_\_  
TEL \_\_\_\_\_

AF 13/90

**QUESTION OF SPORT ONLY £4.99**

**BLOODWYCH + DATA DISC BOTH ONLY £14.99**

# TURBOSOFT

**SIM CITY + TERRAIN EDITOR BOTH ONLY £22.99**

**Music X + Midi Interface Only £119.99**

## FORTHCOMING ATTRACTIONS

SlySpy	£16.99
Blue Angels	£16.99
European Superleague	£13.99
Pool of Radiance	£19.99
Shadow Warrior	£16.99
Addas Golden Shoe	£16.99
U.M.S. II	£15.99
Damocles	£16.99
Myth	£16.99
Blade Warrior	£16.99
Liverpool - The Game	£16.99
Chess Champion 2175	£18.99
The Punisher	£16.99
Chaos Strikes Back	£16.99
Dynasty Wars	£16.99
Kick Off 2	£12.99
Starflight	£16.99
Last Ninja II	£16.99
Battle Master	£16.99
Back To The Future 2	£16.99
Escape From The Planet Of The Robot Monsters	£12.99
Star Trek V	£16.99
Tusker	£16.99
Verminator	£15.99
Tower Of Babel	£14.99
Barbarian II (Psynosis)	£15.99
Neuromancer	£16.99
Lost Patrol	£15.99
Delta Armalyte	£13.99
Tie Break	£16.99
Bomber Mission Disc	£13.99
Dynamic Debugger	£16.99
F19 Stealth Fighter	£22.99
Final Battle	£16.99
Gin & Cribbage	£20.99
A.M.C.	£16.99
Hot Rod	£16.99
Red Storm Rising	£16.99
Imperium	£16.99

**AMIGA EXTERNAL DRIVE + Shadow of the Beast, Kick Off, R.V.F. Honda, Battle Squadron. UNBEATABLE VALUE @ ONLY £129.99**

## ACCESSORIES

Mouse Mat 6mm	£3.99
Mouse House	£3.99
Amiga 500 Dust Cover	£4.99
Amiga 4 Player Adaptor	£7.99
Disc Cleaning Kit	£1.99
Naksha Mouse	£29.99
Contriver Mouse	£22.99
40 Lockable Disc Box	£5.99
80 Lockable Disc Box	£7.99
Box 10 Sony Branded Discs	£9.99
Box 10 Bulk Discs	£6.99
Cheetah 125+	£7.99
Quickjoy Joystick	£12.99
Navigator with Autofire	£10.99
Speeding with Autofire	£9.99
Pro 5000	£12.99

1 Meg Upgrade Only	£54.99
1 Meg + Dungeon Master	£69.99
1 Meg + Dragons Lair	£79.99
1 Meg + Escape Singes Castle	£64.99
1 Meg + Gold of the Realm	£59.99
1 Meg + Space Ace	£69.99
1 Meg + Hero's Quest	£74.99
1 Meg + It Came From The Desert	£74.99

## ART & SOUND

Studio Magik	£52.99	Deluxe Video III	£59.99
Fanavision	£24.99	Deluxe Music Cons.Set	£49.99
A.M.O.S.	£34.99	Deluxe Paint II	£9.99
Photon Paint II	£22.99	Studio 24	£134.99
Deluxe Paint III	£59.99	Track 24	£59.99
Deluxe Print II	£34.99	Mastersound	£32.99

## TOP 50 CHART

Xenon II	£12.99	Resolution 101	£16.99
Klax	£9.99	International 3D Tennis	£16.99
Hero's Quest (1 Meg)	£23.99	T.V. Sports Basketball	£19.99
Manhunter In San Francisco (1 Meg)	£19.99	Dragons Breath	£18.99
Turrican	£13.99	Manchester United	£24.99
Ghostbusters II	£16.99	Castle Master	£14.99
Operation Thunderbolt	£16.99	Rainbow Islands	£16.99
Chase HQ	£16.99	Player Manager	£11.99
Bomber	£19.99	Leisure Suit Larry 3	£26.99
Cyberball	£12.99	Hammerfest	£16.99
Iron Lord	£16.99	Conqueror	£16.99
Iron 1990	£16.99	X-Out	£13.99
Midwinter	£18.99	Pipe Mania	£14.99
Hard Drivin'	£11.99	Pirates	£16.99
Ghouls 'n' Ghosts	£16.99	Lost Dutchmans Mines (1 Meg)	£14.99
Stunt Car Racer	£16.99	Escape from Singes Castle	£26.99
Pro Tennis Tour	£16.99	Skidz	£13.99
It Came From The Desert (1 Meg)	£19.99	Knights of the Crystallion	£20.99
Kick Off 2 + World Cup	£15.99	Rotor	£11.99
Jumping Jackson	£12.99	Sherman M4	£16.99
Ant Heads Data Disc	£9.99	Super Cars (Gremlin)	£16.99
Kid Gloves	£14.99	F-29 Retaliator	£16.99
Space Ace	£26.99	Warhead	£16.99
Their Finest Hour	£19.99	Emlyn Hughes Soccer	£12.99
Ivanhoe	£16.99	Ultimate Golf	£16.99
Colorado	£16.99		

### TRIPLE PACK - ONLY £16.99

Hostages, Purple Saturn Day, Kult

### COMPUTER HITS II - ONLY £8.99

Tetris, Black Shadow, Golden Path, Joe Blade

### PRECIOUS METAL - ONLY £15.99

Captain Blood, Xenon, Arkanoid II, Crazy Cars

### SUPREME CHALLENGE FLIGHT COMMAND - ONLY £19.99

Eliminator, Skychase, Strike Force Harrier, Lancaster, Skyfox II

### TIME AND MAGIK - ONLY £7.99

Lords of Time, Red Moon, The Price of Magik

### MAGNUM 4 - ONLY £19.99

Afterburner, Double Dragon, Operation Wolf, Batman The Caped Crusader

### WORLD CUP COMPILATION - ONLY £14.99

Tracksuit Manager, Kick Off, International Soccer

### LIGHT FORCE - ONLY £16.99

Bio Challenge, Ik +, R-Type, Voyager

### TRIAD 3 - ONLY £19.99

Rocket Ranger, Speedball, Blood Money

### WICKED GAMES PACK - ONLY £9.99

Bouncer, Pacbie, Backgammon, Invaders, Ball Raider II, Swooper, Spaceballer, Diablo, Zitrax, Othello

## SPECIAL OFFERS

Leaderboard	£6.99	North And South	£9.99	Battle Squadron	£11.99
Rocket Ranger	£9.99	Pacland	£7.99	Chambers of Shaolin	£5.99
Marble Madness	£7.99	Pacmania	£7.99	Running Man	£4.99
Bards Tale I	£7.99	IK+	£4.99	Bloodwych	£9.99
Dragon Spirit	£7.99	Starglider II	£7.99	Interphase	£9.99
New Zealand Story	£7.99	Conflict in Europe	£7.99	Treasure Island Dizzy	£4.99
Shufflepuck Cafe	£7.99	Seconds Out	£4.99	Gauntlet II	£7.99
T.V. Sports Football	£12.99	Lombard RAC Rally	£9.99	Spy Vs Spy	£4.99
Galaxy Force	£3.99	Joan of Arc	£7.99	Spy Vs Spy II	£4.99
Sim City	£14.99	U.M.S.	£9.99	Spy Vs Spy III	£4.99
Casino Roulette	£2.99	Blasteroids	£4.99	Thunderbirds	£4.99
Brian Clough's Football	£6.99	Trivial Pursuits	£9.99	F/ball Manager II +	
F-18 Interceptor	£7.99	Nebulus	£4.99	Exp Kit	£12.99
Eliminator	£4.99	Cyberoid II	£4.99	Breach	£4.99
Fish	£7.99	Netherworld	£4.99	Daily Double Horse	
Trivial Pursuit New Begin.	£6.99	Hollywood Poker Pro	£7.99	Racing	£9.99
Super Wonderboy	£7.99	Gold of the Realm (1 Meg)	£4.99	Centrefold Squares	£7.99
Kristal	£9.99	Baal	£4.99	Boulderdash Const Kit	£4.99
Emmanuelle	£7.99	Menace	£4.99	Dynamite Dux	£7.99
Lords of the Rising Sun	£11.99	Ballistix	£4.99	Blood Money	£9.99
Drakken	£14.99	Shadow of the Beast	£12.99	Captain Blood	£4.99
Batman the Movie	£7.99	Laser Squad	£8.99	Barbarian Psynosis	£6.99
Fernandez Must Die	£3.99	Passing Shot	£4.99	Millenium 2.2	£9.99
Art Of Chess	£4.99	3 Stooges	£7.99	Drum Studio	£4.99
Hunt For Red October	£9.99	Tank Attack	£7.99	Sidewinder II	£4.99

## CLASSIC COLLECTION

Dungeon Master (1 Meg)	£15.99
Dungeon Master Editor	£7.99
Battlechess	£16.99
3D Pool	£13.99
Colossus Chess X	£12.99
Steve Davis Snooker	£9.99
Kings Quest Triple Pack	£24.99
Falcon	£19.99
Flight Simulator II	£26.99
Lombard R.A.C. Rally	£15.99
Operation Wolf	£15.99
Scenery Disk 7, 9 or 11	£13.99
Scenery Disk Japan or Europe	£13.99
War in Middle Earth	£13.99
Airborne Ranger	£15.99
Robocop	£16.99
Waterloo	£15.99
Twin World	£16.99
Kick Off Extra Time	£5.99
Battlechess	£16.99
Wayne Gretzky's Hockey	£15.99
Deluxe Scrabble	£13.99
Dragons Lair (1 Meg)	£26.99
Bards Tale II	£16.99
Ferrari Formula 1	£16.99
Grand Prix Circuit	£16.99
Sword of Sodan	£16.99
Ultima IV	£16.99
Zak McKracken	£16.99
Forgotten Worlds	£13.99
Maniac Mansions	£16.99
Test Drive II	£16.99
Shoot 'em Up Construction Kit	£19.99
Balance of Power 1990	£19.99
R.V.F. Honda	£16.99
Indy Jones The Adventure	£16.99
Kick Off	£12.99
Falcon Mission Disc	£13.99
Populous	£16.99
Populous Promised Lands	£7.99
Altered Beast	£11.99
Super Cars (T.D. II Disc)	£8.99
California Challenge (T.D. II Disc)	£8.99
Muscle Cars (T.D. II Disc)	£8.99
Austerlitz	£16.99
688 Attack Sub	£16.99
Battlehawks 1942	£16.99
Elite	£12.99
Gunship	£12.99
Microprose Soccer	£12.99
Carrier Command	£12.99
Finnish Freddy's Big Top Fun	£16.99
F-16 Combat Pilot	£16.99
Dragons of Flame	£16.99
Keef The Thief	£16.99
Borodino	£19.99
Demons Tomb	£12.99
Hillstar	£16.99
Cloud Kingdoms	£14.99
Leisuresuit Larry I	£16.99
Leisuresuit Larry II	£19.99
Space Rogue	£18.99
Horse Racing	£16.99
Heroes of the Lance	£16.99
Manhunter in New York	£19.99
Omega	£19.99
Pictionary	£16.99
Postman Pat	£6.99
Risk	£13.99
Hound Of Shadow	£16.99
Turbo Outrun	£12.99
World Tour Golf	£7.99
Red Lightning	£19.99
Full Metal Planet	£16.99
European Challenge (T.D. II)	£8.99
Tracksuit Manager	£13.99
European Space Shuttle	£24.99
The Cycles	£16.99
Bridge Player 2150	£19.99
Times of Lore	£16.99

## UTILITIES & BUSINESS

A-Max (Mac-Emulator)	£109.99	Mavis Beacons Typing	£19.99
A-Max with 128K ROMS	£209.99	Kindwords	£37.99
Dev/Pac II	£44.99	Protext V.4	£59.99
Digicalc	£27.99	Pagesetter	£89.99
Hisoft Basic	£59.99	Transport Controller	£149.99
Lattice C V.4	£164.99	Draw 2000	£189.99

## EDUCATIONAL

Discover Chemistry	£13.99	Puzzle Storybook	£19.99
Fun School II (under 6)	£12.99	Rhyming Notebook	£19.99
Fun School II 6-8	£12.99	Dinosaur Discovery Kit	£19.99
Fun School II 8+	£12.99	My Paint	£22.99
Kid Talk	£24.99	German Master	£13.99
Math Talk	£24.99	French Mistress	£13.99
Discovery Maths	£24.99	Spanish Tutor	£13.99
Discovery Words	£24.99	Italian Tutor	£13.99
First Letters & Words	£19.99	Answer Back Junior	£19.99
First Shapes	£19.99	Answer Back Senior	£13.99

Please note that not all forthcoming attractions are released at the scheduled time. These will be despatched within 24 hours of release, subject to availability.

**41 SOUTH STREET, LEIGHTON BUZZARD, BEDS, LU7 8NT TEL: 0525 377974 FAX: 0525 852278**

## ORDER FORM



Please supply me with the following for Computer

Titles	Price

DATE: .....

NAME: .....

ADDRESS: .....

..... Post Code

TEL: .....

AMIGA FORMAT AUGUST '90

Please make cheques & PO payable to **Turbosoft**

Orders under £5 please add 50p per item. Over £5 p&p **FREE** in UK. Elsewhere please add £1.50 per item. N.B. Please state clearly mode of computer & also cassette or disc when ordering

# Amiga peripherals that won't cost you an arm and a leg...



**A500**  
**1/2 MEG**  
**£47**

**EXTERNAL FLOPPY DRIVE**  
**£60**  
3.5" WITH SWITCH AND THROUGH PORT SILENT MECHANISM

**A590 RAM CHIPS**  
**FROM £39**

**A2000**  
**V6.2 UK SPEC NOT IMPORTED**  
**£849**  
REV. 6.2B 1MB AGNUS 1-3 KICKSTART

**A2000 RAM UPGRADES**  
**£289**  
8MB CARD 2MB FITTED

**HARD DISKS**  
FOR ANY AMIGA SEE BELOW

*M.E.S. aren't tied down to any one manufacturer. Our aim is to bring you the best Amiga peripherals from all over the world.*

**RAM UPGRADES**

- MES HALF MEG (with free 1MB Demo) **£47**
- MINIMAX + 2 MEG INTERNAL **£289**
- EXP 8000 + 8 MEG INTERNAL (2MB fitted) **£329**
- MICROBOTICS 8-UP 8 MEG A2000 (2MB fitted) **£289**
- SUPRARAM 8 MEG A2000 (2MB fitted) **£289**

**HARD DISKS** - SYSTEMS BY VORTEX, XETEC, GVP, SUPRA, MICROBOTICS - CALL FOR PRICING  
68030 ACCELERATOR CARDS - A2000 FROM **£699**

**A590 RAM UPGRADES**

- 1/2 MEG **£39**
- 1 MEG **£75**
- 2 MEG **£145**

**COMPETITION**  
**Win a floppy drive!**



Send your caption on a postcard to the address below, along with your name and address.

**TRADE ENQUIRIES WELCOME**



Send cheques to: Dept AF  
**Memory Expansion Systems Ltd.**  
Britannia Buildings, 46 Fenwick Street,  
Liverpool L2 7NB  
**(051) 236 0480**

PRICES ARE SUBJECT TO CHANGE WITHOUT NOTICE



(051) 236 0480 • 24 Hour Sales  
(051) 227 2482 • 24 Hour Fax

MAD SUMMER SALE MAD SUMMER SALE

# PUBLIC APOLOGY

M.D. Office Supplies would like to take this opportunity of apologising to all its competitors. Our **MAD SUMMER SALE** will be offering Discs, Storage Boxes etc. at **UNBELIEVABLE, UNREPEATABLE, MAD, MAD PRICES**. As ever the best cost less at M.D. Office **WE GUARANTEE IT.**

## JUST MARVEL AT THESE INCREDIBLE OFFERS

### 3.5" DISCS & BOXES

35 3.5" DS-DD 135 TPI with 100 Capacity Lockable Storage Box.....	£21.95
45 3.5" DS-DD 135 TPI with 100 Capacity Lockable Storage Box.....	£29.95
55 3.5" DS-DD 135 TPI with 100 Capacity Lockable Storage Box.....	£34.95
65 3.5" DS-DD 135 TPI with 100 Capacity Lockable Storage Box.....	£39.95
75 3.5" DS-DD 135 TPI with 100 Capacity Lockable Storage Box.....	£44.95
100 3.5" DS-DD 135 TPI with 100 Capacity Lockable Storage Box.....	£54.95
150 3.5" DS-DD 135 TPI with 2, 100 Capacity Lockable Storage Boxes.....	£74.95
200 3.5" DS-DD 135 TPI with 2, 100 Capacity Lockable Storage Boxes.....	£84.95

OUR 3.5" DISCS ARE **VERY CAREFULLY SELECTED** TO GIVE **UNQUESTIONABLE** reliability and incredible **VALUE for money**. Each diskette is supplied with a label and is **Certified 100% error free**.

### 5.25" DISCS & BOXES

25 5.25" DS-DD 96 TPI With 100 Capacity Lockable Storage Box.....	£13.50
50 5.25" DS-DD 96 TPI With 100 Capacity Lockable Storage Box.....	£18.50
75 5.25" DS-DD 96 TPI With 100 Capacity Lockable Storage Box.....	£24.50
100 5.25" DS-DD 96 TPI With 100 Capacity Lockable Storage Box.....	£29.95
200 5.25" DS-DD 96 TPI With 100 Capacity Lockable Storage Boxes.....	£52.99

OUR 5.25" DISCS ARE **VERY CAREFULLY SELECTED** TO GIVE **UNQUESTIONABLE** reliability and incredible **VALUE for money**. Each diskette is supplied with a label and is **Certified 100% error free** and is offered with our 100% money back guarantee and is supplied with envelopes, W.P. tabs.

#### HIGH DENSITY 3.5" DISCS

10 DS HD 3.5" Discs in plastic library case.....	£14.99
30 DS HD 3.5" Discs with 50 Capacity Box.....	£44.95
50 DS HD 3.5" Discs with 100 Capacity Box.....	£59.95
100 DS HD 3.5" Discs with 100 Capacity Box.....	£99.95

(For larger quantities please ring)

#### HIGH DENSITY 5.25" DISCS

25 DS HD 1.6 Meg with LOCKABLE STORAGE BOX.....	£16.99
50 DS HD 1.6 MEG with LOCKABLE STORAGE BOX.....	£34.99
75 DS HD 1.6 MEG with LOCKABLE STORAGE BOX.....	£46.99
100 DS HD 1.6 MEG with LOCKABLE STORAGE BOX.....	<b>£57.99</b>

(For larger quantities please ring)

#### LOW LOW PRICES FOR BULK BUYERS

For all you large users we have some unbeatable bulk rates on our superb DS-DD 3.5 discs.

300 DS DD 135tpi.....	£139.95
400 DS DD 135tpi.....	£179.95
500 DS DD 135tpi.....	£220.00
600 DS DD 135tpi.....	£258.00
800 DS DD 135tpi.....	£335.00
1000 DS DD 135tpi.....	£389.95

As always lifetime guaranteed, unquestionable reliability, each disc is supplied with label.

#### NEW EXCITING PRODUCTS

New, New, New products to enhance your computers productivity and performance.

- External Disc Drives, slimline, very quiet, very reliable **only £59.95**  
Atari and Amiga
- Replacement Mice, smooth operation, precise movement **only £19.95**  
2 Piece Universal Printer Stands (cuts down on space) **£6.95**
- Stackable disc boxes 80 capacity and lockable. **1 off - £9.95 3 off - £8.95 5 off - £7.95**  
Can be stacked horizontally or vertically as you please.
- Tilt 'n' Turn 14" Monitor Stand, a superb investment **only £11.95**
- Data Switches 2 way manual switch (State serial or parallel) **only £12.95**

#### PRICE & QUALITY GUARANTEE

M.D. Office Supplies prides itself on offering the **HIGHEST QUALITY** products at the best possible prices. In the unlikely event that you should see a **COMPARABLE** product offered cheaper in this magazine **DO NOT HESITATE** give us a call because we won't match that price.

**WE WILL BEAT IT - GUARANTEED**

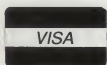

## M.D. OFFICE SUPPLIES

18 CRESCENT WAY, FARNBOROUGH, KENT BR6 9LS  
TELESALES HOTLINES: 0689-61400

Trade Accounts Welcome

All prices include VAT and Delivery UK only E/OE

Education Orders Welcome

MAD SUMMER SALE MAD SUMMER SALE

# That Year

## in Full!



By popular demand, we present a complete guide to the first 12 issues of AF.

### FEATURES

Title	Issue	Page			
The Amiga - History of...	4	17	Part 5 - Aliens 2	11	119
The Amiga - Inside...	4	17	Part 6 - Collisions	12	155
Comms - a Beginner's Guide	5	99	A Serious Business		
Cyberpunk	6	145	Part 1 - Databases	10	91
Desktop Video Editing	8	15	Part 2 - Spreadsheets	11	127
The Dream Machine	2	27	Part 3 - Accounts	12	145
DTP - Colour Programs	3	65	IFF Tutorial	9	105
DTP - Khartomb designers	4	89	Kickstart 1.3 - How to fit it	3	89
DTP - Low cost programs	2	71	Multimedia - What is it?	9	15
DTP - Pageplay designers	5	73	Phasor Strike - laser game	12	127
DTP - Scanners	6	133	Poster Printing Innovation	4	12
Edinburgh Animation Festival	4	127	Printers - 9-Pin models	11	31
Education - in the Classroom	3	107	Printers - 9-Pin models	11	31
Education Software	12	131	Rahman Haleem Interview	1	14
Encryption Tutorial	12	161	Shoot-em-up Construction Kit	1	26
Football Games round up	12	81	Simulations	6	17
Fractals and Chaos	11	15	Starter's Guide to the Amiga	7	17
Games Programming:			Stocking Filler Gadgets	6	138
Part 1 - System Control	7	63	The Third Dimension	5	19
Part 2 - Scrolling	8	63	Top Ten Games	1	58
Part 3 - The Ships	9	63	Video - Alternative Image	1	17
Part 4 - Aliens 1	10	85	Video Digitiser round-up	4	65
			Video Digitising - do it well	10	23
			Wordprocessor round-up	5	146
			Workbench tutorial	6	117

TITLE	ISSUE	PAGE	RATING
African Raiders	1	54	68%
Alien Legion	3	45	52%
Altered Beast	5	63	33%
APB	5	64	81%
Armada	7	49	82%
Arthur	3	87	89%
Atomix	10	59	61%
688 Attack Sub	10	56	86%
Austerlitz	8	53	FG 91%
Astaroth	3	56	41%
Axel's Magic Hammer	7	54	67%
Bad Company	8	46	71%
Basketball	2	54	65%
Battle Squadron	7	43	82%
Batman	5	38	FG 90%
Black Tiger	10	55	71%
Bloodwych	5	58	79%
Cabal	9	49	71%
Castle Master	11	72	89%
Castle Warrior	4	49	53%
The Champ	2	44	48%
Chase HQ	7	37	82%
Circus Attractions	1	46	56%
Classic Invaders	1	54	9%
The Colony	11	66	51%
Colorado	11	54	62%
Commando	7	50	71%
Conflict Europe	4	57	65%
Conqueror	9	32	FG 93%
Continental Circus	4	45	71%
Crackdown	10	66	67%
Cyberball	11	57	71%
The Cycles	9	47	84%
Dan Dare III	12	72	67%
Deja Vu II	3	86	82%
Demon's Tomb	9	50	80%
Dominator	3	40	28%
Double Dragon II	6	40	64%
D.R.A.G.O.N. Force	12	55	83%
Dragons Breath	9	36	FG 94%
Dragons of Flame	8	54	62%
Dragon Spirit	5	52	67%
Drakkhen	8	50	73%
Dr Plummet's			
House of Flux	9	38	77%
Dynamite Dux	4	41	64%
Dyter 07	11	59	47%
Escape from the Planet			
of the Robot Monsters	11	78	82%
Eye of Horus	6	44	61%
F-16 Combat Pilot	3	42	FG 94%
Federation of			
Free Traders	2	42	69%
Fiendish Freddy's			
Big Top of Fun	3	49	59%
Fighter Bomber	9	54	87%
Fire	9	42	43%
F-29 Retaliator	11	62	FG 92%
Drivin' Force	9	46	81%
5th Gear	8	46	42%
Fighting Soccer	6	56	43%
Fire Brigade	2	44	88%
Full Metal Planet	8	47	75%
Future Wars	6	67	84%
The Games:			
Summer Edition	5	48	61%
Galaxy Force II	7	38	47%
Garfield:			
The Winter's Tail	4	46	43%
Gemini Wing	3	50	68%
Ghostbusters II	6	73	79%
Ghouls 'n' Ghosts	7	32	FG 91%
Gold Rush	3	87	38%
Grand National	10	59	30%
Grand Prix Circuit	2	53	78%



ALL PRICES INCLUDE V.A.T.  
Add £3.95 For Post & Packaging  
Next Day Courier £9.95



Please make cheques payable to E.P.D.

CORPORATE EDUCATION & TRADE  
ENQUIRIES WELCOME

## EUROPEAN PERIPHERAL DISTRIBUTION

Peripheral House  
DEPT AF, Unit 36 Cranford Gardens  
Compton Acres  
West Bridgford  
Nottingham  
NG2 7SE

Telephone (0602) 841640

### BANX DISK BOX

The most economical 3.5" disk storage system, with all these features on the market

**Pull out drawer.**

**Lockable** with two keys.

**Stackable** both up & sideways.

**Holds 90 3.5" Disks**

**ONLY £11.95**



### 3.5" DISKS FROM 39p

Double sided 3.5" Discs, Individually Wrapped, 880K 135tpi, ideal for Amiga, ST, Etc. Made in Japan. 100% Error Free. 2 for 1 Warranty or Money back.

Minimum Quantity 50 Disks

**£0.39 each**

Genuine 'Sony' 3.5" discs. Double sided. Made in Japan, sold in Sony outers, probably the best disks in the world!

Minimum Quantity 50 Disks

**£0.42 each**

3.5" Diskette box holds either 100 or 50 3.5" disks

box to hold 100 3.5" Disks

box to hold 50 3.5" Disks

Prices for disk boxes are if disks bought at same time.

**£4.95**  
**£3.95**  
**£3.50**  
**£19.95**

CRAZY PRICES  
ON AMIGAS -  
FLIGHT OF FANTASY  
PACK - BATPACK -  
CLASS OF THE 90'S -  
RING FOR DETAILS

A500 Dust Cover

Replacement Amiga Mouse

with free mouse mat & mouse holder

**£3.50**  
**£19.95**

**STOP PRESS STOP PRESS STOP PRESS**

**CHINNON 3.5" EXTERNAL DRIVE NEW IN,  
LATEST SLIMLINE DESIGN  
ONLY £62.95**

**A590 RAM UPGRADE CHIPS 1/2 Mb £39 - 1Mb £79 - 2Mb £159**

### AMIGA PERIPHERALS

Sourced From Europe's Leading Electronic Manufacturers

Sound Sampler for A500/1000 inc. Software **£29.99**

Midi Interface. High Quality for A500/1000/2000 midi in. midi through. 2 midi outs. **£29.99**

Boot Selector for A500/1000/2000 allows you to boot from an external drive DF1. **£14.95**

Kickstart Card for Amiga A500/2000 allows you to switch between Kickstart 1.2 or 1.3 (Includes original rom 1.2 or 1.3 please state) easy to fit, no soldering. **£49.95**

### END YOUR VIRUS PROBLEMS!

Hardware device that simply plugs in to disk drive port and prevents any boot block virus writing itself to your expensive disks. Protects internal drive as well as any other floppy drive connected. Through port. On/Off switch. L.E.D. to indicate protection on.



**£19.95**

Will work with all known Virii

### 512K RAM UPGRADE

Amiga A500 ram expansion, one of the smallest expansions on the market. Top marks when reviewed in Amiga Format. Inc FREE 1Mb demo.

Replaces A501 expansion.

Built in Clock version **£48.95**  
Without Clock **£44.95**



**£48.95**

**STOP PRESS 2Mb £215**

### NORDIC POWER CARTRIDGE

Get the most from your computer. Get inside where the action is. Freeze it to ice for tomorrow's use. Easy to fit, easy to use. It is a must for expert programmers and beginners. Impress your friends with the ultimate computer tool. Once you have used it you will never work without it!

\* SUPER PROGRAMME FREEZE (SAVES LEVEL TO REPLAY AT ANY TIME) \* BACKUP FOR 2 DRIVES \* FULL MACHINE LANGUAGE MONITOR (DISASSEMBLER ANY FILE AND SEE HOW IT WORKS, ASSEMBLE YOUR OWN CODE, HEX DUMPS, ETC.) \* GRAPHIC UTILITY (GETS ANY SCREEN OUT OF A GAME, NUMEROUS ADJUSTMENTS FOR GRAPHICS, SAVE AS IFF FILES, ETC.)



SOUND SCANNER (FIND SAMPLES WITHIN A GAME, SAVE SOUNDS AS IFF FILES, SOUND EDITOR TO ALTER SOUNDS FOR YOUR OWN USE) \* TRAINING MODE (SLOW DOWN A GAME TO GET PASSED THAT DIFFICULT LEVEL) \* INTEGRATED SLIDE SHOW (COMPILE A DISK OF YOUR FAVOURITE GRAPHICS AND VIEW THEM FROM THE SLIDE SHOW) \* MANY MORE FEATURES TOO NUMEROUS TO MENTION \* RING FOR DETAILS.

**£59.95**

PICTURE REPRODUCED BY KIND PERMISSION FROM DATA & ELECTRONICS

NORDIC POWER & ACTION CARTRIDGE ARE REGISTERED TRADEMARKS



## REVIEWS

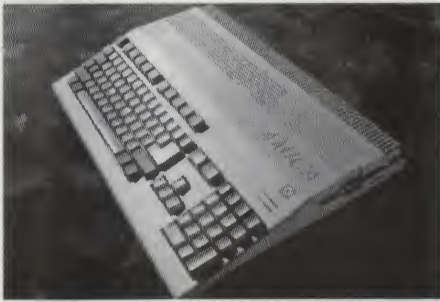

A1500	11	82
A590 Hard Disk	2	13
Action Replay Cartridge	12	88
A-Max Mac Emulator	1	64
Amos Preview	9	95
Argasm	4	31
Bars and Pipes	12	27
Books	11	123
Boing Mouse	5	69
Class of the '90s	10	72
Copyist Apprentice	10	134
Crossdos	8	69
Deluxe Video 3	9	23
DigiPaint 3	3	28
DigiView 4	9	102
Distant Suns	10	124
Dr T's Voicing Software	7	112



Elan Performer	6	157
Fast Fax	11	145
Futuresound 500	1	31
Geni-scan 4000 Scanner	10	153
GFA Basic Compiler	8	127
Hisoft Extend	8	127
Home Office Kit	6	165
KCS Version 3.0	10	129
Logo	7	101
Marcam's Video Digitiser	7	107
Mastersound	8	95
Master Tracks Pro	5	122
Microtext	6	161
Musical Enlightenment	9	113
Music X	3	20
Music X Junior	9	127
Naksha Mouse	7	95
Nordic Power Cartridge	12	88
PageSetter 2	8	83
PASE	5	124
PC Powerboard	9	83
Pen Pal	5	138
Quartet	11	87
Real-time Sound Processor	1	73
Sound Blaster	10	116
Sound Trap III	6	153
Studio Magic	9	116
Tipster	7	95
Trackballs	10	116
Trip-A-Tron	7	98
TV* Show 2	11	155
TV* Text Professional	10	77
The 20 Card	11	153
UltraCard	8	102
UltraDesign	10	121
Video Studio	2	85
Vidi Amiga	3	30
Vidi-Chrome	10	29
X-Cad Designer	1	63
X-Specs 3D	9	69
Xetec FastTrack hard drive	5	133

## GRAPHICS



Introduction to Graphics	2	17
Deluxe Paint Tutorial	3	25
Photon Paint 2 vs DigiPaint 3	4	26
3D Modelling	5	29
Using lines tutorial	6	31
The Visual Art of Karl Torok	7	24
The Art Critic	8	23
Deluxe Video 3 Review	9	23
Using colour tutorial	10	17
Using digitised images	11	23
Real Things - Birds	12	31

## MUSIC

MUSIC-X Perf: anigaform1.per

BEGIN	END	CUE1	CUE2
PAUSE	◀	▶	▶ PLAY ▶▶
Clock: 0001.01.000			
00:00:00.00			
092			
Memory: 17681 Events			
Seq	Men	Bars	Channels
001	1113	1	16
002	1163	1	16
003	1983	1	16
004	1183	1	16
005	---	---	---
006	---	---	---
007	---	---	---
008	---	---	---
009	---	---	---

Introduction to Amiga Music	1	68
Sequencing	2	97
Music X review	3	20
Synthesizing	4	97
Samplers	5	127
PD music programs	6	109
Voice synthesizing	7	111
Sequencing Tutorial	8	96
Musical Enlightenment	9	113
Studio Magic	9	113
Copyist Apprentice	10	129
KCS v3.0	10	129
Frankfurt Music Fair report	11	103
Making music for beginners	12	17

Gravity	11	46	FG 91%
Gunship	1	45	87%
Hammerfest	12	68	89%
Hard Drivin'	7	34	50%
Heavy Metal	12	57	77%
Herewith the Clues	10	39	80%
High Steel	2	53	39%
Highway Patrol	10	43	48%
Hillsfar	5	41	72%
Hot Rod	11	54	66%
Impossamole	12	58	60%
Hound of Shadow	7	58	45%
Indiana Jones and the Last Crusade	2	57	77%
Indiana Jones			
The Adventure Game	6	61	71%
Infection	4	53	83%
Infestation	10	47	89%
International Championship Wrestling	11	48	24%
Interphase	4	38	88%
Iron Lord	7	38	77%
Ivanhoe	12	75	52%
The Island of Lost Hope	11	60	80%
Italia'90	10	62	27%
Italy'90	12	52	80%
It Came from the Desert	7	47	80%
Jack Nicklaus' Golf	3	39	78%
Journey	1	43	82%
Jumping Jack Son	12	64	81%
Keef the Thief	6	49	89%
Kenny Dalglish			
Soccer Match	8	38	31%
Kick Off	1	34	FG 91%
Kick Off Extra Time	7	54	45%
Kid Gloves	10	69	61%
Knight Force	7	50	33%
Knights of Crystallion	9	40	FG 91%
Kult	2	34	FG 92%
Lancaster	5	47	61%
Laser Squad	5	52	FG 93%
Legend	5	60	52%
Legend of Djel	5	60	59%
Licence to Kill	2	48	71%
Magic Marble	6	64	73%
Manchester United	10	62	62%
Manic Miner	10	40	25%
Mayday Squad	1	43	67%
Midwinter	12	40	FG 92%
Microprose Soccer	1	34	67%
Might and Magic	11	65	73%
Moonwalker	6	41	68%
Mr Heli	5	64	52%
Myth	4	53	87%
Navy Moves	1	56	53%
New Zealand Story	1	38	FG 94%
Ninja Spirit	12	46	63%
The Ninja Warriors	6	43	88%
North and South	6	70	74%
Nuclear War	11	48	51%
Oil Imperium	3	45	66%
Omega	7	53	87%
Onslaught	6	59	78%
Operation Thunderbolt	7	56	88%
Outlands	8	36	51%
Overlander	9	46	81%
P 47	8	37	80%
Paperboy	4	46	41%
Paris-Dakar	10	39	37%
Phobia	2	54	72%
Pinball magic	8	36	75%
Pipe Mania	9	53	81%
Pirates	9	38	77%
Player Manager	10	65	FG 93%
Powerdrift	5	42	FG 92%
Powerdrome	1	49	FG 92%
Predator	5	57	22%

Prince	7	44	54%
Protector	12	75	52%
Pro Tennis Tour	5	54	87%
Pursuit to Earth	8	49	19%
Quartz	5	63	68%
Quest for the Time Bird	5	58	82%
Rainbow Islands	10	36	FG 95%
Rally Cross Challenge	6	50	64%
Rampage	1	53	72%
Resolution101	12	60	87%
Red Lightning	4	61	FG 90%
Rick Dangerous	2	37	89%
Risk	9	35	85%
Robocop	3	42	73%
Rock'n'Roll	6	64	86%
Rotor	9	42	84%
Rotox	12	63	84%
Safari Guns	6	76	42%
SAS Combat Simulator	11	75	44%
Scramble Spirits	10	66	54%
Seven Gates			
of Jambala	8	38	79%
Shadow of the Beast	4	42	78%
Sherman M4	10	43	77%
Shinobi	4	50	36%
Shogun	3	84	76%
Shufflepuck Cafe	4	50	49%
Sim City	6	55	FG 92%
Skate of the Art	3	40	38%
Skidz	12	43	86%
Skweek	1	53	78%
Slayer	5	47	43%
Sleeping Gods Lie	2	40	80%
Space Ace	8	41	62%
Space Rogue	11	53	55%
Spherical	1	56	64%
Sporting Triangles	6	76	65%
Storm Across Europe	12	70	80%
Stormlord	6	76	62%
Strider	3	36	FG 91%
Stunt Car Racer	6	45	FG 93%
Supercars	8	35	86%
Superleague Soccer	6	50	48%
Super Puffy's saga	8	42	57%
Super Wonderboy	8	49	19%
Switchblade	6	46	85%
Swords of Twilight	6	70	68%
Tennis Cup	11	59	83%
Theme Park Mystery	12	44	82%
Tintin on the Moon	5	44	38%
Toobin'	6	75	72%
Tower of Babel	11	42	FG 95%
Treasure Trap	12	52	68%
Turbo Outrun	6	68	70%
Twin World	6	56	81%
Typhoon Thompson	10	40	80%
Their Finest Hour	11	71	FG 90%
The Untouchables	8	33	87%
TV Sports Basketball	10	50	51%
Ultimate Golf	12	51	88%
Vindicators	1	37	81%
Voyager	1	37	79%
Vulcan	4	58	83%
Warhead	10	44	88%
Waterloo	3	55	FG 92%
Wayne Gretzky			
International Hockey	1	40	70%
Wipe Out	12	67	85%
World Championship			
Boxing Manager	11	75	76%
World Cup Soccer			
Italia'90	11	77	74%
Xenon 2	3	52	FG 93%
Xenomorph	11	45	83%
Xenophobe	5	57	76%
X-Out	7	40	78%
Xybots	2	47	77%
Zork Zero	3	84	FG 92%

## COVERDISK

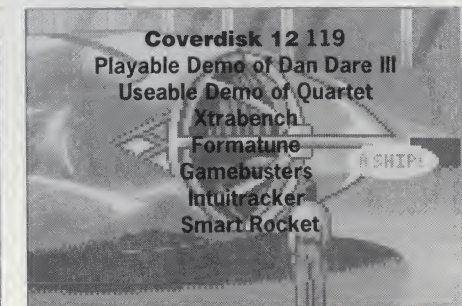
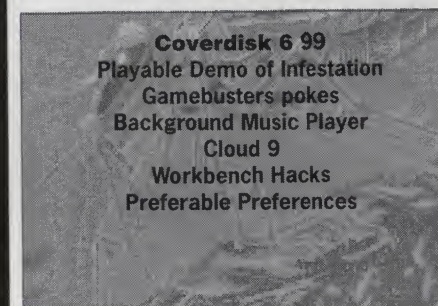
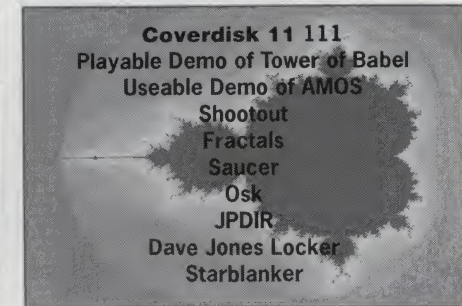
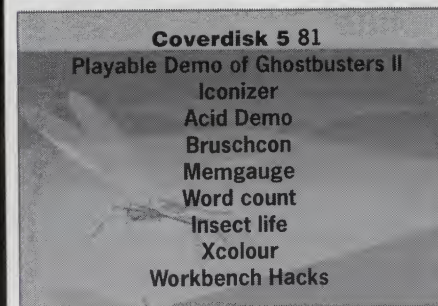
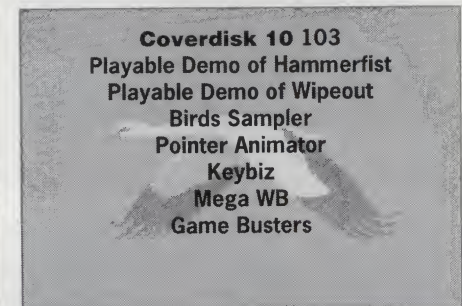
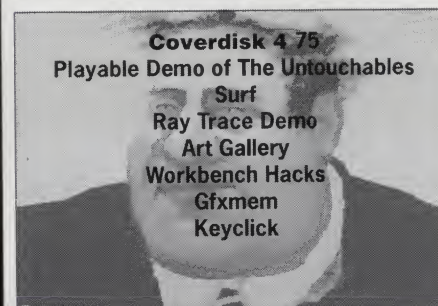
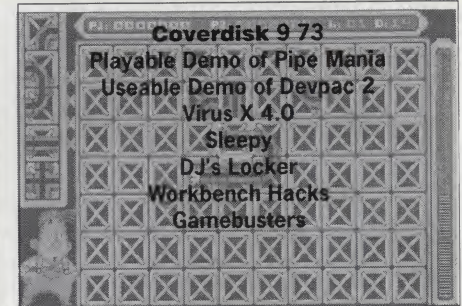
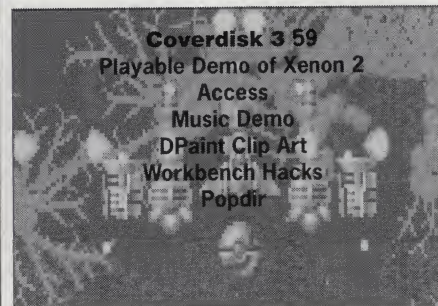
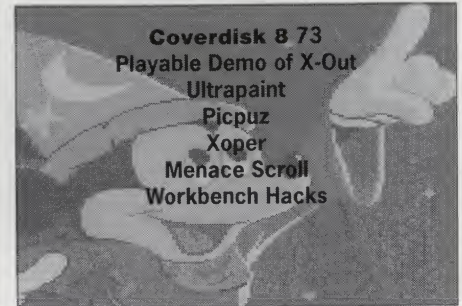
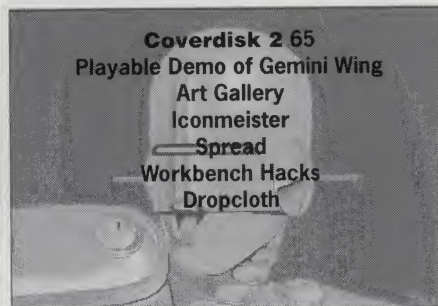
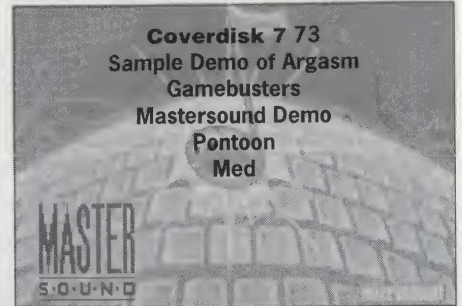
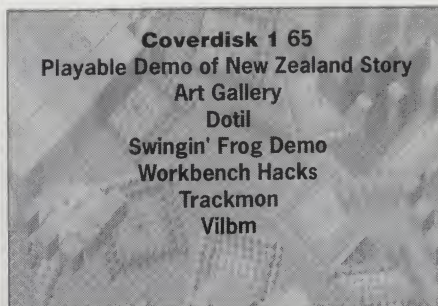



# EALING COMPUTER CENTRE

NOW!  
FREE  
DELIVERY  
ALL ITEMS!

No. 1 place for AMIGA COMPUTERS  
in West London. All prices inc. V.A.T.

## This Months Special Promotions

BUSINESS COLLECTION  
AMIGA: KIND WORD 2, K-DATA,  
K-SPREAD 2

£69.99

3.5" EXTERNAL DRIVE 1MB (NEC  
/ CHINON) SWITCH, THRU PORT

£63.99

### Hardware

Amiga 500 Batman Pack .....£375.99  
Amiga 500 Flight of Fantasy.....£375.99  
ALL WITH 4 TITLES, TV MODULATOR, MOUSE.

### Monitors (WITH AMIGA CABLE)

Philips 8833 Colour Stereo.....£299.99  
Commodore 1084 Colour Stereo.....£239.99

### Drives (EXTERNAL)

Cumana 1Mb Drive 3.5" .....£79.99  
3.5" 1Mb Drive (NEC/Chinon) .....£63.99  
Amiga 20Mb Hard Disk Drive  
(incl. 3 software titles).....£369.99  
5.25" Drive (NEC/Chinon) 1Mb.....£119.99

### Accessories

Amiga Mouse.....£24.95  
Memory Upgrade 0.5Mb.....£49.99  
As Above with Clock.....£55.99  
Power Supplies.....£39.00

### Printers (ALL WITH CABLES) ALL UK SPECIFICATIONS

Mannesman Tally MT81 .....£134.95  
Star LC-10 .....£159.99  
Star LC-10 MKII.....£198.99  
Star LC-10 Colour.....£209.99  
Star LC-24-10.....£239.00  
Panasonic KXP1180.....£169.99  
Panasonic KXP 1124.....£269.99

### Software

Photon Paint 2.....£14.09  
Spritz (Graphic Soft).....£9.99  
Tenstar Pack.....£29.99  
Kind Words 2.....£29.90  
Superbase.....£29.90  
K-Data.....£26.90  
K-Spread 2.....£26.90  
K-Graph 2.....£26.90

Business Collection:  
Kind Words 2, K-Data, K-Spread 2....£69.95

19 Queens Parade, Ealing, London W5 3HU. Tel 081-991 0928

Prices include delivery for software and small items. Courier Delivery of hardware 57.99. UK mainland only \* Above prices for mail order, Shop prices may vary \* All offers subject to availability. E&OE. We are the corner of Hanger Lane (North Circular) & Queens Drive  
\* Easy parking \* Most models in stock \* VISA AND ACCESS

10 DISKS 3.5" ONLY  
DS DD £4.99

with any purchase.  
Lowest price in U.K.?

# AMIGA POWER SUPPLY

## £39.99

A520 Modulator .....£17.99

Genuine Commodore 1 Year Warranty

Prices include VAT & P&P.

Send Cheque/PO to:

OMNIDALE SUPPLIES (Dept F1),  
23 Curzon Street, Derby,

DE1 2ES.

Tel: (0332) 291219



# GUNFIGHTER



USE YOUR VOICE  
TO OUTDRAW  
THE GUNFIGHTER

CASH PRIZES

# 0898 31 35 99

INFODIAL POBox 36 LS1 4TN Call charges 25p Per Min Cheap 38p Per Min All Other Times

# SOVEREIGN

93 COTSWOLD AVE  
DUSTON  
NORTHAMPTON  
NN5 6DP



# SOFTWARE

THE KIOSKS  
GREYFRIARS BUS STATION  
LADY'S LANE  
NORTHAMPTON  
NN1 3BZ

ORDER BY TELEPHONE: 0604 756951 - 7am - 7pm 7 days a week

**MAGNUM 4**  
Batman Crusader,  
Afterburner,  
Double Dragon,  
Operation Wolf  
**£19.95**

**FLIGHT COMMAND**  
Eliminator, Sky  
Fox II, Lancaster,  
Sky Chase, Strike  
Force Harrier  
**£18.95**

**WORLD CUP**  
Kick Off,  
Int. Soccer,  
Tracksuit  
Manager  
**£15.95**

**PRECIOUS METAL**  
Crazy Cars,  
Arkanoid,  
Captain Blood,  
Xenon  
**£15.95**

### TOP 30 MOVERS

688 Submarine Sim.....£16.95  
Balance Of Power 1990.....£16.95  
Cabal.....£15.95  
Chaos Strikes Back.....£16.95  
Conqueror.....£15.95  
Cyber-Ball.....£14.95  
Double Dragon II.....£13.95  
Drakken.....£20.00  
Dungeon Master.....£16.95  
F16 Falcon.....£16.95  
F29 Retaliator.....£15.95  
Fighter Bomber.....£20.95  
Ghouls 'n' Ghosts.....£16.95  
Indy Jones Graphic.....£16.95  
Italy 1990.....£16.95  
It Came From The Desert.....£20.95

### SMASH HIT

A.P.B. ....£13.95	Gravity.....£15.95	Onslaught.....£16.95
Acidus Golden Shoe.....£16.95	Gunship.....£16.95	Pinball Magic.....£16.95
Aquanaut.....£15.95	Hard Drivin'.....£13.95	Pipe Mania.....£16.95
Altered Beast.....£15.95	Heavy Metal.....£16.95	Populous.....£15.95
American Ice Hockey.....£16.95	Hound Of Shadow.....£16.95	Rainbow Islands.....£16.95
Austerlitz.....£16.95	Iron Lord.....£15.95	Run The Gauntlet.....£15.95
Battle Chess.....£16.95	International 3D Tennis.....£16.95	Shoot Em Up Const Kit.....£20.95
Beach Volley.....£15.95	Jack Niklaus Golf.....£16.95	Sim City.....£19.95
Beyond Dark Castle.....£15.95	Kick Off II.....£16.95	Sonic Boom.....£16.95
Black Tiger.....£15.95	Last Ninja.....£14.95	Space Harrier II.....£15.95
Bloodwych.....£15.95	Lost Patrol.....£16.95	Starflight.....£16.95
Champions Of Kyrin.....£16.95	Liverpool.....£13.95	Subbuteo.....£14.95
Chambers Of Shaolin.....£15.95	Lombard RAC Rally.....£16.95	T.V. Sports Football.....£14.95
Chase HQ.....£15.95	Manchester United.....£16.95	Theme Park Mystery.....£16.95
Damocles.....£16.95	Maniac Mansion.....£15.95	Turbo Outrun.....£15.95
Double Dragon II.....£13.95	Ninja spirit.....£16.95	Twin World.....£16.95
Dragon Ninja.....£15.95		Ultra IV.....£15.95
Elite.....£15.95		Uninvited.....£15.95
F19 Stealth Fighter.....£19.95		Untouchables.....£15.95
F16 Falcon.....£16.95		Wendy Dreams.....£15.95
Flood.....£15.95		Xenomorph.....£16.95
Future Wars.....£16.95		Xenon II.....£14.95
Gazza's Super Soccer.....£15.95		Zak McKracken.....£16.95
Ghostbusters II.....£15.95		Zork Zero.....£15.85

WIN £100 WORTH OF  
SOFTWARE  
Free entry with every order  
Winner published in  
September issue  
Closing date 24th July

Please make cheques & postal orders payable to  
**SOVEREIGN SOFTWARE**

ALL GAMES SUBJECT  
TO AVAILABILITY

### COMPELLING BUYS

Action Service.....£3.95	Espionage.....£5.95	Rocket Ranger.....£12.95
Archipelagos.....£6.95	Eliminator.....£6.95	Safar Guns.....£9.95
Baal.....£10.95	F18 Interceptor.....£4.95	Sargon III.....£6.95
Bad Company.....£10.95	Fast Lane.....£9.95	Shufflepuck Cafe.....£9.95
Barbarian II.....£9.95	Galaxy Force.....£10.95	Skidoo.....£9.95
Batman The Movie.....£9.95	Ghnius.....£5.95	Soldier 9000.....£9.95
Blasters.....£9.95	Kick Off.....£12.95	Star Blaze.....£10.95
Bloodmoney.....£11.95	Laser Squad.....£6.95	Star Gladiator II.....£12.95
Boulderdash Const Kit.....£6.95	New Zealand Story.....£9.95	Star Ray.....£7.95
Bugsy Boy.....£9.95	Operation Neptune.....£9.95	Str Crazy (featuring BoBo).....£9.95
Conflict Europe.....£10.95	Passing Shot.....£5.95	Take Em Out.....£9.95
Cosmic Pirate.....£9.95	Prospector.....£6.95	Tin Tin On The Moon.....£10.95
Dragon Spirit.....£9.95		Toobin.....£11.95

**TRIAD VOL III**  
Bloodmoney,  
Speedball  
Rocket  
Ranger  
**£19.95**

**LIGHT FORCE**  
Voyager,  
R-Type,  
Bio Challenge,  
IK  
**£15.95**

**PRFMIER  
COLLECTION**  
Nebulus, Exolon,  
Netherworld,  
Zynaps  
**£17.95**

**3 FOR 1**  
Hostages,  
Kult,  
Pu,le Saturn  
Day  
**£16.95**

### TOP 30 MOVERS

Ivanhoe.....£15.95  
Midwinter.....£19.95  
Ninja Warrior.....£13.95  
Operation Thunderbolt.....£15.95  
Player Manager.....£14.95  
Pro Tennis Tour.....£15.95  
Shadow Of The Beast.....£17.85  
Sherman M4.....£16.95  
Space Ace.....£26.95  
Space Shuttle III.....£23.95  
T.V. Sports Basketball.....£19.95  
Their Finest Hour.....£20.95  
U.M.S. II.....£16.95  
Ultimate Golf.....£16.95  
Warhead.....£16.95

# PRICE BLITZ

**THOSE WHO DO NOT RESPOND WILL  
SERIOUSLY DAMAGE THEIR WEALTH  
HURRY - HURRY - HURRY**

**S  
A  
V  
E  
  
£'s  
£'s  
£'s  
£'s**

**S  
A  
V  
E  
  
£'s  
£'s  
£'s  
£'s**

**3 1/2 DS-DD 135TPI SPECIAL OFFERS**

25 DS DD 135TPI 100% ERROR FREE, PLUS deluxe lockable storage box.....	£17.99
50 DS DD 135TPI 100% ERROR FREE, PLUS deluxe lockable storage box.....	£31.99
75 DS DD 135TPI 100% ERROR FREE, PLUS deluxe lockable storage box.....	£44.99
100 DS DD 135TPI 100% ERROR FREE, PLUS deluxe lockable storage box.....	£59.99

**5 1/4 DS-DD SPECIAL OFFERS**

25 DS DD 100% ERROR FREE, PLUS deluxe storage box.....	£12.95
50 DS DD 100% ERROR FREE, PLUS deluxe storage box.....	£18.95
75 DS DD 100% ERROR FREE, PLUS deluxe storage box.....	£24.95
100 DS DD 100% ERROR FREE, PLUS deluxe storage box.....	£29.95

175 DS DD 135TPI 100% ERROR FREE, PLUS 2 boxes.....	£94.99
250 DS DD 135TPI 100% ERROR FREE, PLUS 3 boxes.....	£124.99

200 DS DD 100% ERROR FREE, PLUS 2 boxes.....	£56.99
300 DS DD 100% ERROR FREE, PLUS 3 boxes.....	£82.49

All our 3.5 DSDD are certified 100% error free and lifetime guaranteed. All discs supplied with labels.

All our 5.25 DSDD are certified 100% error free and lifetime guaranteed. All discs supplied with labels.

**3 1/2 HIGH DENSITY SPECIAL OFFERS**

10 HD 1.44MB 100% ERROR FREE IN A PLASTIC LIBRARY CASE.....	£14.99
25 HD 1.44MB 100% ERROR FREE, PLUS deluxe lockable storage box.....	£34.99
50 HD 1.44MB 100% ERROR FREE, PLUS deluxe lockable storage box.....	£59.99
100 HD 1.44MB 100% ERROR FREE, PLUS deluxe lockable storage box.....	£99.99

**5 1/4 HIGH DENSITY SPECIAL OFFERS**

25 HD 1.2MB 100% ERROR FREE, PLUS deluxe storage box.....	£16.99
50 HD 1.2MB 100% ERROR FREE, PLUS deluxe storage box.....	£29.99
75 HD 1.2MB 100% ERROR FREE, PLUS deluxe storage box.....	£42.99
100 HD 1.2MB 100% ERROR FREE, PLUS deluxe storage box.....	£49.99

All HD 3.5 Discs CARRY THE HD LOGO, and are certified 100% error free, lifetime warranted for reliability and performance, and supplied with labels.

All HD 1.2 MEG 5.25 are certified 100% error free, lifetime warranted for reliability and performance, and supplied with full user sets, labels etc.

**BULK BUYERS**

<b>3 1/2</b>	DOUBLE SIDED	<b>3 1/2</b>
	DOUBLE DENSITY	
500	£230.00	
1000	£369.95	

**IMPORTANT NOTICE**  
Please note we do not sell cheap discs.  
We sell incredibly high quality discs  
**!CHEAP!**

**ACCESSORIES**

80 Capacity Stackable Boxes.....	£12.95
Universal Printer Stands.....	£6.95
14" Tilt 'n' Turn Monitor Stands.....	£10.95
Atari or Amiga Replacement Mice.....	£19.95

**COLOURED 3.5" DSDD Discs**

25 DSDD 135TPI Rainbow Discs.....	£16.99
50 DSDD 135TPI Rainbow Discs.....	£33.99
75 DSDD 135TPI Rainbow Discs.....	£49.99
100 DSDD 135TPI Rainbow Discs.....	£62.99

(packs are supplied in 5 different colours)

**Disc-X-PRESS**

101 BURNHAM ROAD, DARTFORD, KENT DA1 5AZ

TEL: 0322 289817 OR 0322 287687

All supplies are subject to availability. All prices inclusive of VAT & Delivery UK only



# When you're talking AMIGA talk to Microsnips

In fact, whatever your needs, we have over 3,600 different computers and accessories in stock – all backed by the knowledgeable, highly professional service that has made us one of the most respected

computer dealers in Britain. So whether you're looking for hardware, software or just some expert free advice, consult the Amiga specialists. Talk to Microsnips.

## AMIGA FLIGHT OF FANTASY PACK

Including 'Extras', Workbench 1.3, Manuals, Modulator, Rainbow Islands, F-29 Retaliator, Escape From The Planet of the Robot Monsters, Deluxe Paint 2, Mouse Mat, 5 free disks, Mouse Holder and Disc Box.

NOW ONLY £399.00

### DISC DRIVES

Cumana 3 1/2" 1mg Amiga	£89.95
MGT Lifetime 1mg Drive (suits all computers with suitable lead)	£139.00
Q-Tec 3 1/2" 1mg Amiga Drive	£79.95
Cumana 5 1/4" Amiga Drive	£139.95
A590 20mg Amiga Hard Disk	£399.00

### MONITORS

Philips CM8833 Stereo/Medium Res	£249.00
Commodore 1084 Colour	£229.00
Amiga-Scart Lead	£10.95

### DISK MEDIA

20 3 1/2" DSDD 100% Certified Disks	£18.95
30 5 1/4" DSDD 100% Certified Disks	£9.95
10 3 1/2" TDK DSDD Disks	£14.50
Lockable Disk Box Holds 50 – 5 1/4"	£6.99
Lockable Disk Box Holds 40 – 3 1/2"	£6.99
Lockable Disk Box Holds 100 – 3 1/2"	£7.95
Mouse Holders	£2.99
Vision 10 Storage Box 3 1/2"	£1.95
Vision 10 Storage Box 5 1/4"	£1.95
Mouse Mat 8mm Quality	£3.99

### PRINTERS & ACCESSORIES

Apollo RF/Anti Surge Trailing 4-Way Socket	£24.95
Amiga/Centronics Cable (2m)	£9.95
Citizen 120D	£149.95
Panasonic KX-P1124 Printer	£299.00
Panasonic KX-P1081 Printer	£179.00
Star LC10 Mono	£179.00
Star LC10 Colour	£229.00
2000 Sheets Fanfold/Microperf	£15.95
Star LC10 Colour Ribbons	£7.95
Panasonic/Star/Epson Ribbons	£3.99
80 Column Printer Stand	£9.95

RING 051-630 3013 TO ORDER  
or for FREE CATALOGUE  
Answerphone 6.00 p.m. – 9.00 a.m.



OVERSEAS CUSTOMERS NOTE  
Postgiro International accepted. NOT  
Postbank Postcheque. Books not taxable –  
Europe add £5. Non Europe add £10. We  
reserve the right to charge carriage at cost.

UK POSTAGE AND PACKING. Items under £50  
add £2. Items under £100 add £5. Items over £100  
add £10 for Group 4 Courier ensuring delivery the  
day after the despatch. Overseas customers  
(Europe): Full price shown will normally cover  
carriage and free tax. Non Europe add 5% to total.

# MICROSNIPS

*Making technology work for you!*

37 SEAVIEW ROAD, WALLASEY, MERSEYSIDE L45 4QN  
051-630 3013 051-630 5396 051-691 2008  
FAX: 051-639 2714 Personal Callers Welcomed

# BACK ISSUE SERVICE

Few in stock, selling out fast  
– get your copies while they last!  
All issues only £3.65\*, Coverdisk  
and full postage included



ISSUE 1  
SORRY SOLD OUT!



ISSUE 7  
SORRY SOLD OUT!



ISSUE 2  
SORRY SOLD OUT!



ISSUE 8  
A wild shoot-em-up, X-Out, on the disk. The essential guide to using the Amiga in video inside - you too can be a video star.



ISSUE 3  
SORRY SOLD OUT!



ISSUE 9  
A special on the latest buzzword in computing, Multimedia, and how the Amiga is ideal for it. Pipe Mania provides an extremely addictive disk demo.



ISSUE 4  
SORRY SOLD OUT!



ISSUE 10  
TWO playable demos on the disk - Hammerfest and Wipe Out. Inside - a graphics special and getting down to some serious stuff with a feature on databases.



ISSUE 5  
SORRY SOLD OUT!



ISSUE 11  
Disk and mag combine to take you on a guided tour of fractals and chaos theory. There's a playable demo of the stunning Tower of Babel, which is just one of four Format Golds inside.



ISSUE 6  
SORRY SOLD OUT!



ISSUE 12  
Massive Music special featuring a step-by-step guide on how to write your own tunes, plus free music tape. Dan Dare III on Disk along with useable demo of new music program Quartet.

\*UK price only Overseas prices: Europe £5 Rest of World £7  
To order your back issues use the subscriptions order form opposite.

# DON'T MISS OUT

# CHOOSE ONE OF THESE TOP THREE TITLES

## F29 RETALIATOR

YOURS FREE (RRP £24.99)



Take to the skies with Ocean's action-packed combat flight sim based on the world's most advanced jet fighters.

## RESOLUTION 101

YOURS FREE (RRP £24.95)



Crack crime as you race around a futuristic city in your high-powered, heavily-armed ground skimmer dealing death to the local drug barons.

## PIPE MANIA

YOURS FREE (RRP £24.99)

Fantastic and original puzzle action game from Entertainment International - lay the pipes to keep the Flooz flowing.



### YOUR NO RISK GUARANTEE

You can cancel your subscription at any time and we will refund you for all unmailed issues.

# FREE GAME!

WHEN YOU SUBSCRIBE TO AMIGA FORMAT

## PLUS...

You guarantee yourself a regular copy of Britain's leading magazine for the Amiga, absolutely jam-packed with all the information you need to get the most out of your machine.

## PLUS...

You make sure you get the tremendous Coverdisk every month, bursting with exciting programs, utilities and playable demos.

### 12 ISSUES OF YOUR FAVOURITE MAGAZINE

PLUS COVER DISK PLUS FREE GAME

- ALL THIS FOR ONLY £34.95!

Or, if you're a bit hard up this month...

**6 ISSUES FOR JUST £17.95** (but sadly no free game)

Simply complete the coupon below and return to us ASAP

**CAN'T WAIT?** Then phone our **CREDIT CARD HOTLINE** on **0458 74011**

and ask for Trevor Witt for a fast and friendly service.

## YES!

I want to claim my free game (only applies to 12 issues subscriptions)

My choice is as follows (please tick one only)

F29 RETALIATOR       RESOLUTION 101       PIPE MANIA

Please enter my subscription to Amiga Format (tick as appropriate)

UK (12 issues) .....£34.95       UK (6 issues) .....£17.95

Europe (12 issues) .....£59.55       Rest of World (12 issues) ....£84.55

To ensure you get the best possible service all overseas subscriptions are sent Air Mail

Please also send me the following back issues (see opposite page)

8   9   10   11   12 (please circle)

Name \_\_\_\_\_

Address \_\_\_\_\_  
\_\_\_\_\_

Post Code \_\_\_\_\_

Total payment £ \_\_\_\_\_ My method of payment is (tick your choice)

Cheque (make payable to Future Publishing Ltd)

Visa       Access      Expiry date \_\_\_\_\_

Card No

Enclose this coupon (together with your cheque if applicable) in an envelope to:

Amiga Format Subscriptions, FREEPOST, Somerton, TA11 7BR



**MAKE CHEQUES/POSTAL ORDERS  
PAYABLE TO UNICORN SOFTWARE**  
ORDERS UNDER £15.00 ADD 75P P&P

**8 BIT AND 16 BIT HARD/SOFTWARE SPECIALISTS**

**JUST IN HAND HELD  
TEENAGE MUTANT HERO TURTLES ..... ONLY £20.99**

**ATARI AND AMIGA GAMES**

F29 Retaliator .....	£18.99
Rainbow Islands .....	£18.99
Kick Off .....	£15.99
Italy 1990 .....	£18.99
Crackdown .....	£18.99
Chase HQ .....	£18.99
Dragons Lair 2 .....	£34.99
Klax .....	£18.99

**CONSOLES**

Sega Mega Drive with FREE  
game ... **ONLY £185.00**  
PC Engine Supergraf - X  
**ONLY £279.00**  
Neo Geo now in stock the  
ultimate games console  
**ONLY £430.00**

**HAND - HELD GAMES**

Double Dragon .....	£24.99
Nemesis 3 .....	£20.99
Skate Or Die .....	£20.99
Topgun .....	£20.99

**HAND - HELD CONSOLES**

Nintendo Game Boy with FREE  
game ... **ONLY £109.00**  
Also available Atari Lynx  
**ONLY £180.00**

**AMIGA FLIGHT OF FANTASY PACK.....£399.00**

**ATARI ST DISCOVERY PACK .....£289.00**

**UNIT 58, CITY BUSINESS PARK, SOMERSET PLACE,  
STOKE, PLYMOUTH, DEVON PL3 4BB  
☎ (0752) 606353**

**HECKMATE  
DIGITAL  
LIMITED**



**A1500 Expansion Unit  
for the Amiga A500**  
**For further details / prices ring**  
Telephone 071-923 0658  
CheckMate Digital Limited,  
80 Mildmay Park, London N1 4PR  
Fax: 071-254 1655

**MAIL  
ORDER**

**SOFTSELLERS LTD**

**MAIL  
ORDER**

**6 BOND STREET, IPSWICH, SUFFOLK IP4 1JE**

5A DOG'S HEAD STREET, IPSWICH, SUFFOLK. (RETAIL)



36A OSBORNE STREET, COLCHESTER, ESSEX. (RETAIL)

**MAIL ORDER PURCHASE LINE (0473) 257158/210605 FAX NO: (0473) 213457**

**JOYSTICKS**

Cheetah 125 .....	£7.99
Cheetah Starprobe .....	£11.99
Pro 5000 Extra Glo Green .....	£13.99
Pro 5000 Extra Glo Red .....	£13.99
Pro 5000 Black .....	£11.99
QS Turbo III .....	£9.99
Euromax Racemaker .....	£24.99
Konix Navigator .....	£11.99

**DISC BOXES WITH DISCS**

3.5" 40 Holder Lockable with 10 3.5" DSDD discs.....	£12.99
3.5" 40 Holder Lockable with 20 3.5" DSDD discs.....	£19.99
3.5" 40 Holder Lockable with 40 3.5" DSDD discs.....	£33.99
3.5" 80 Holder Lockable with 10 3.5" DSDD discs.....	£15.99
3.5" 80 Holder Lockable with 40 3.5" DSDD discs.....	£35.99
3.5" 80 Holder Lockable with 80 3.5" DSDD discs.....	£55.99

**PERIPHERALS**

Replacement mouse + mouse holder + mouse mat .....	£29.95
Four Player Adaptor .....	£5.95
Mouse Mat .....	£4.95
Joystick Extender .....	£5.95
Dust Cover .....	£4.95

**DISCS**

Quantity	10	20	50	100
3.5" DSDD Unbranded	£7.99	£14.99	£34.99	£59.99
3.5" DSDD Sony Branded	£11.99	£22.99	£54.99	£99.99

**DISC BOXES**

3.5" 40 Holder Lockable.....	£5.99
3.5" 80 Holder Lockable.....	£7.99
5.25" 50 Holder Lockable.....	£4.99
5.25" 120 Holder Lockable.....	£6.99

CHEQUES AND POSTAL ORDERS PAYABLE TO SOFSELLERS. POST AND PACKING FREE IN UK. OVERSEAS £1.50 PER ITEM except hardware charged at cost.  
Subject to availability and price change without notice. \*Some titles may not be released at time of going to press.  
Shop prices may vary, but personal callers can claim advertised discounts on production of cut-off slip.



**THE TIPSTER**

I have three little tips that you might be interested in. They all concern *DPaint II*.

**Tip One**

To customise one of the brushes at the top of the toolboxes, all that you have to do is bring the mouse to the brushes box and click the right mouse button. It will ask you to customise it by clicking on the left mouse button and dragging to the desired size.

**Tip Two**

This helps with the magnifying glass - when you are looking closely at a part of the picture and you want to move it on a notch up or down, left or right. All you do is go through the usual procedure to get your magnified picture. Then simply put the pointer over the part of the screen that's blown up and use the arrow keys to move.

**Tip Three**

This one's just for fun. When you first load *DPaint II*, click on the right mouse button over the fill-in tool, and a box will appear. Click in the box with the up and down arrows in the lower part of the screen. Then click on the OK box. Choose a colour (preferably yellow). Fill the screen, and it should come up in all colours.

Josh Yates

# Workbench

The usual inordinately useful selection of queries answered and tips provided is brought to you once more, this time courtesy of **KEITH POMFRET**.

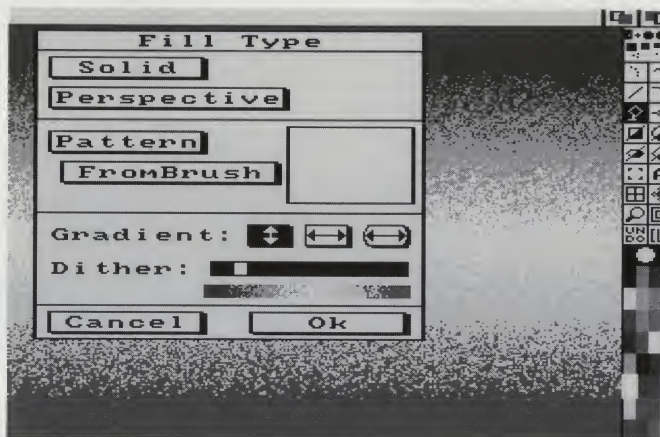

An interesting experiment in *Deluxe Paint II*. See the Tipster!

**INK STINK**

Here's a money-saving tip for those of your readers who have printers with rather expensive ribbons. I have a Commodore 1500c (an Olivetti). Unfortunately, the colour ribbons cost £25 each and I have not succeeded in finding a plain black, which one would expect to be a little cheaper.

Since the majority of my printing is done in script (plain black) something had to be done. I found that it is possible to prise off the lid with a sharp knife. Inside is a stack of four foam plastic rollers, impregnated with coloured ink. The black one is the top one.

Lift this roller out and it is possible to replenish it using Ink Pad Ink, available from any reasonable office supplier. Replace everything as it was, and your ribbon is good for weeks. I am using the original ribbon that came with the printer over a year ago, although I am using the blue band now as the black was showing signs of wear. Contrary to rumour, I have experienced no clogging of the pins.

The two inks which I have used are Stephens Endorsing Ink and Swallow Stamp Ink.

Mike Pitchers

*Clogged pins you may not have but you are certainly heading the right way for a dead printer. The ink on a printer ribbon contains silicon or some other purpose-designed matrix head lubricant. By using a simple endorsing ink instead of the proper stuff, you are most certainly damaging your expensive printer. Would you pour inverted sugar syrup into the engine of your car because it looked like multigrade oil? I certainly wouldn't.*

*Until recently, the only option other than to buy a new ribbon was to send it to a re-inking service. These charged you a couple of quid to make your pale ribbon strident again.*

*To fill the needs of the do-it-yourself merchants such as yourself, the silicon ink is now available in an aerosol can. It's called Caspell Ribbon Refresh and costs a mere £8 for a can that will do dozens of ribbons. The can comes with an applicator (like the WD40 can) and after putting a sheet of newspaper down, the job of re-inking a ribbon only takes a few seconds. Ribbon Refresh is available from WACCI on 081-898 1090.*

**FRENCH RHYTHMS**

The other day I was writing a program to discover and print people's biorhythms. One part of it needed code to produce a graphic dump of a graph. I thought first of utilising part of the *Screenprint* routine by Carolyn Scheppner on the Extras disk. However, I needed to know whether the Preferences printer was in colour, black-and-white or greyscale to see how the screen colours should be set. This is the code I came up with.

```
Sub getprintertype STATIC
  SHARED printer.type$
  OPEN "devs:system-configuration" FOR INPUT AS #1
  FORI=1 TO 174
    p$=INPUT$(1,#1)
    NEXT I
  CLOSE#1
  IF ASC(p$)=1 THEN
    printer.type$="GREY SCALE":EXIT
  SUB
  IF ASC(p$)=2 THEN
    printer.type$="COLOUR":EXIT
  SUB
  IF ASC(p$)=3 THEN
    printer.type$="BLACK AND WHITE":EXIT
  SUB
  PRINT "No can do! Couldn't decipher the system configuration
```

END SUB

Simple, isn't it? It works, though. All you have to do is insert a "Getprintertype" somewhere in the program, and hey presto! the string printertype\$ contains the type of printer available. If anyone wants a copy of the biorhythm program, lob us a disk and a stamp and I'll send it to them.

David French  
GATEACRE, Devon Road  
Salcombe, Devon, TQ8 8HQ

**MEMORIES...**

I own an Amiga 500 and recently upgraded it to 1 meg with the Commodore A501 RAM/Clock expansion. I am now considering buying the A590 hard drive, with which there is an unpopulated RAM expansion upgradable to 2 megs.

I would like to know if, with this 2 meg expansion, I will be able to use the A501 RAM expansion and have a total of three megs or whether the A501 will be useless and I will only be able to use the 2 megs with the A590.

As well as this, I want to know if the A590 will run as comes or if I need any other hardware.

Stephen Bishop

*Breathe again, you can carry on shovelling chips into an Amiga A500 right up to its 8 Mb ceiling providing your peripherals and hardware have adequate sockets. With some of the new higher density boards that go in the socket under the A500, this could mean a 512K on-board, 1.5 Mb underneath and 2Mb in your A590, a total of 4 Mb on board.*

**SINGLE DRIVE TIPS**

I would like to pass on a couple of my tips to other user of an Amiga who only have a DFO: (single

**WORLDWIDE SOFTWARE**  
106A Chilwell Road, Beeston  
Nottingham NG9 1ES

**WORLDWIDE SOFTWARE**

**WORLDWIDE SOFTWARE**  
106A Chilwell Road, Beeston  
Nottingham NG9 1ES

Commodore Amiga Software	
688 Sub Attack	£17.95
A.M.C.	£17.95
A.M.O.S.	£39.95
Aoidas Champ Football	£17.95
All Dogs Go To Heaven	£17.95
All Time Favourites	£22.95
Anarchy	£14.95
Ant Heads Data Disk	£14.99
Bards Tale 2	£17.95
Bards Tale	£7.25
Batman the Movie	£17.95
Battlehawks 1942	£17.95
Battlemaster	£22.95
Betrayal	£16.95
Black Tiger	£17.95
Blade Warrior	£17.95
Bomber Mission Disk	£14.95
Bomber	£22.95
Boxing Manager	£14.95
Breach 2	£17.95
Buggy Boy	£9.99
Cartoon Capers	£14.95
Castle Master	£17.95
Champions of Krynn 1 meg	£22.95
Chase HQ	£17.95
Chess Champion 2175	£22.95
Cloud Kingdoms	£17.95
Codename Iceman	£26.95
Colorado	£17.95
Combo Racer	£17.95
Conflict in Europe	£17.95
Conflict	£4.99
Conqueror	£17.95
Crackdown	£17.95
Damocles	£16.95
Dan Dare 3	£14.95
Dark Century	£16.95
De Luxe Scrabble	£14.95
Defenders of the Earth	£17.95
Double Dragon 2	£14.95
Dragon Flight	£22.95
Dragon Force 1 meg	£22.95
Dragons Breath	£22.95
Dragons Of Flame	£17.95
Dungeon Master 1 meg	£17.95
Dungeon Master Editor	£7.99
Dynamic Debugger	£17.95
Dynasty Wars	£17.95
Dyer 7	£14.95
E Motion	£17.95
Edition One	£17.95
Elite	£16.95
Emlyn Hughes Soccer	£17.95
Escape Planet of Robot Monsters	£14.95
Escape Simpas Castle	£32.95
Everton FC Intelligensia	£14.95
F16 Combat Pilot	£16.95

Commodore Amiga Software	
F16 Falcon Mission Disk	£14.95
F16 Falcon	£21.95
F19 Stealth Fighter	£22.95
F29 Retaliator	£17.95
Ferrari Formula One	£17.95
Finest Hour Battle of Britain	£22.95
Fire and Brimstone	£17.95
Fire and Forget 2	£17.95
Fire Brigade 1 meg	£21.95
Flight of Intruder	£22.95
Flight Path 737	£4.99
Flight Simulator 2	£28.95
Flimbod Quest	£17.95

**Summertime Special Offer**

£1.00 off all Amiga titles

Just tell us in which magazine you saw our advert then deduct £1.00 from each title that you order

**BY PHONE**  
0602 252113  
(24 Hours)

Fast Delivery On All Stock Items By 1st Class Mail In UK.  
Special Overseas Service By Air Mail Worldwide.  
Credit Card Orders Accepted by Phone Or Mail.  
Overseas tel no: Nottingham 225368  
Credit Card Order Telephone Lines

**BY PHONE**  
0602 225368

Football Manager World Cup 90	£14.95
Football Manager	£4.99
Fun School 2 (6 to 8 years)	£14.95
Fun School 2 (over 8)	£14.95
Fun School 2 (under 6)	£14.95
Future Wars	£17.95
Ghosts 'n Goblins	£14.95
Grand Prix Circuit	£17.95
Gravity	£17.95
Gunship	£16.95
Hardball 2	£17.95
Harley Davidson	£22.95
Heavy Metal	£17.95
Heroes Quest 1 Meg	£26.95
Hotshots	£9.99
Hunter Killer	£4.99
Ikari Warriors	£9.99
Impossamole	£14.95
Indy Last Crusade Adv.	£17.95
Infestation	£16.95
Internat 3D Tennis	£17.95
Island of Lost Hope	£17.95
It Came from the Desert (1 meg)	£21.95
Italy 1990	£4.99
Italy 1990	£17.95
Ivanhoe	£17.95
Jack Nicklaus Golf	£16.95

Jump Jet	£4.99
Kick Off 2 + World Cup 90	£17.95
Kick Off 2	£14.95
Kick Off Extra Time	£7.99
Kid Gloves	£17.95
Kings Quest 4	£26.95
Kings Quest Triple Pack	£26.95
Klax	£14.95
Knights of Crystallion	£22.95
Last Ninja 2	£17.95
Leisure Suit Larry 3	£29.99
Leisure Suit Larry	£17.95
Life and Death	£17.95
Lost Patrol	£17.95
Manchester United	£17.95
Maniac Mansion	£17.95
Matrix Raiders	£14.95
Midi Interface	£24.95
Midnight Resistance	£17.95
Midwinter	£22.95
Mind and Magic 2	£17.95
Mindroll Quedex	£14.95
Necronom	£17.95
Ninja Spirit	£17.95
Ninja Warriors	£14.95
Nitro Boost	£4.99
North and South	£16.95

Commodore Amiga Software	
Operation Thunderbolt	£17.95
P47 Thunderbolt	£16.95
Paperboy	£14.95
Pinball Magic	£17.95
Pipe Mania	£16.95
Pirates	£17.95

Player Manager	£14.95
Populous Promised Lands	£7.99
Populous	£17.75
Powerboat USA	£14.95
Pro Tennis Tour	£17.95
Projectyle	£17.95
Pyramax	£14.95
Rainbow Islands	£17.95
Red Lightning	£22.95
Red Storm Rising	£17.95
Resolution 101	£17.95
Rings of Medusa	£22.95
Robocop	£17.95

Commodore Amiga Software	
Test Drive 2 Europe Chall.	£11.99
Test Drive 2 Musclecars	£11.20
Test Drive 2 Supercars	£11.20
Test Drive 2 The Duel	£17.95
The Cycles	£17.95
The Plague	£17.95
Theme Park Mystery	£17.95
Thunderstrike	£17.95
Tie Break	£17.95
Toyottes	£17.95
Treasure Island Dizzy	£4.99
Treasure Trap	£17.95
Treble Champions	£14.95
Trad Vol 3	£22.95
Turrican	£14.95
TV Sports Basketball	£22.95
TV Sports Football	£22.95
U.M.S. 2	£17.95
Ultima 5	£22.95
Ultimate Golf	£17.95
Venus The Flytrap	£17.95
Vulcan	£14.95
Waterloo	£17.95
Wipe Out	£14.95
World Cup Soccer 90	£17.95
World Cup Year 90 Compilation	£17.95
X-Out	£14.95
Xenomorph	£17.95
Xenon 2 Megablaster	£17.95
Zombi	£17.95

*****	
512K Expansion + Dungeon Master	£89.99
10 X 3.5" Blank Disk	£9.95
20 X 3.5" Blank Disk	£17.50
30 X 3.5" Blank Disk	£24.95
40 X 3.5" Blank Disk	£32.95
50 X 3.5" Blank Disk	£37.50
*****	
Lockable Disk Storage Boxes	
40 Disk Storage Box	£7.95
80 Disk Storage Box	£8.95
100 Disk Storage Box	£9.95
*****	
Joysticks	
Cruiser	£8.99
QuickJoy 2 Turbo	£9.95
QuickJoy 2 Pilot	£7.95
QuickJoy Supercharger	£12.95
Quickshot Deluxe Digital	£9.99
Quickshot Turbo	£10.95
Speedking Autofire	£10.99
Zip Stick Autofire	£14.95
Competition Pro	£12.95
Competition Pro Extra	£14.95

Europe (other than UK) shipping costs are:  
£1.50 per disc for normal airmail  
£2.50 per disc for express airmail

Please make cheques or postal orders payable to WORLDWIDE SOFTWARE  
All prices include postage and packing in the UK.  
ADVERTISED PRICES ARE FOR MAIL AND TELEPHONE ORDERS  
FAX NO: 0602 430477

Outside Europe shipping costs are:  
£2.00 per disc for normal airmail  
£3.00 per disc for express airmail

**THE BEST SOFTWARE!  
THE BEST SERVICE!  
THE BEST PRICES!**  
UP TO **40%** OFF R.R.P.!!

**Stone MAILSOFT**

**DELUXE PAINT III**  
RRP £79.95  
**STONEPRICE**  
**£55.35**

**WORD PROCESSORS**

Kind Words 2	£34.95
Protext	£64.70
Pen Pal	£99.99
Publishers Choice	£78.70
Word Perfect	£155.99
Mavis Beacon: Typing Tutor	£23.70

**FINANCE**

Cashbook Combo	£49.25
Home Office Kit	£99.99
K-Spread 2	£43.15
Personal Accounts Plus	£24.95
Personal Tax Planner	£24.95
Superplan	£67.50
System 3	£34.95
The Works Platinum	£136.00

**DATABASES**

K-Data	£35.50
Prodata	£55.99
Superbase Personal	£42.50
Superbase Personal 2	£69.90
Superbase Professional	£169.95

**PROGRAMMING**

Devpac 2	£43.50
Hisoft Basic	£57.20
GFA Basic Compiler v3	£22.95
GFA Basic Interpreter v3	£39.90
Lattice C v5	£156.55
Lattice C Developers Pack	£39.90

**EDUCATIONAL**

Fun School 2 (State age required)	£13.90
-----------------------------------	--------

**GRAPHIC/VIDEO**

Teach Yourself: English	£15.95
Teach Yourself: Maths	£15.95
Deluxe Paint III	£55.35
Deluxe Photolab	£53.00
Deluxe Productions	£99.99
Deluxe Video 3	£57.50
Digiview Gold	£99.99
Photon Paint 2	£49.95

**AUDIO/MUSIC**

AMAS (Sampler + MIDI int.)	£74.25
Datel MIDI Master (Interface)	£34.99
Mastersound	£34.70
Music X	£159.99
Quartet	£37.95
Sonix	£49.70

All Prices Inc. VAT & 1ST CLASS POSTAGE!!!  
(FOR RECORDED DELIVERY PLEASE ADD £1.50) CHEQUES/P.O. TO:  
**STONE MAILSOFT (DEPT AF1)**  
46 CHANTRY MEADOWS, ALPHINGTON, EXETER, DEVON EX2 8FR

**Stone MAILSOFT**

**24 hr CREDIT CARD HOTLINE!**  
MasterCard **0392 213695** Access  
ALL PRICES CORRECT & AVAILABLE AT TIME OF GOING TO PRESS. E.&D.E.

floppy disk drive) to rely on.

1. I have been approached by a couple of people who have a single drive and cannot get a directory from a disk other than the Workbench. The method that I describe appears to work only with Workbench 1.3 (on the Amigas that I have tried) and does allow a directory to be displayed.

a Boot up using Workbench 1.3 and double-click the SHELL.

b Move the shell to the top using the drag bar.

c Expand the shell to screen size by dragging the sizing gadget.

d Remove the Workbench 1.3 disk and replace with required disk.

e Wait for the disk to stop accessing and type: cd dfo:

f The prompt should now change to the name of the new disk that you inserted.

g Now type: dir

h the Amiga will prompt you to insert Workbench 1.3. DO THIS - this enables the Amiga to read the DIR command from the C directory

i A prompt will appear asking you to reinsert your new disk in order to read the directory and... as if by magic... your directory actually appears!

It is possible to access any directory on the new disk by typing 'dir (directory name)' in step (g)

2. When using only DFO: to copy disk files from one disk to another, a hell of a lot of disk changes are involved unless all the required files are copied from the original disk to RAM and then from RAM to the new disk, for example...

We need to copy a file called Tester onto a disk called Myfiles. First access the CLI or SHELL using Workbench. Make yourself a temporary directory in RAM (it can be called anything, I chose 'temp') by typing:

makedir ram:temp

Copy the file required into the new directory:

copy Tester to ram:temp

Put the new disk in DFO and copy the file from RAM onto the new disk using;

copy ram:temp/Tester to MyFiles:Tester

The Amiga will ask for the Workbench in order to read the copy command. The prompt to reinsert the volume Myfiles will follow closely and the file will be copied in one go. When the file has been copied type:

delete ram:temp/tester

delete ram:temp

This will free the RAM ready for more work. When using the Workbench, there is a limited amount of RAM available for such

tasks. To copy more than one file or a complete directory, use a DOS utility like Clickdos, Diskmaster, CLI-Wizard, or CLI-Mate. These are available through public domain libraries.

**Graham Morecroft**

*Your hints on file copying are gratefully received but I think that the ease with which PD DOS utilities work should make any manual copying a thing of the past for all but the dedicated wireheads and command-liners.*

*Now if someone would come up with a Multi-Dos utility that would do all of this while tackling Amiga, ST, Mac and PC disks, and at the same time being memory resident and only taking up a couple of kilobytes...*

I am currently taking 'A' level computer studies and I need an IBM PC emulator for my Amiga 500. The emulator needs to be able to run Turbo Pascal, Database and other PC programs. Could you recommend an emulator with the price and where to get it from? Also, is there a Z80 assembler emulator in PD so that I can cross-assemble to my Spectrum++2? The Spectrum has an RS232 (similar to the BT 400 series telephone socket) serial port. Can I buy a lead to link the Amiga to it or, failing that, can I make one?

I would be grateful if you can answer my questions, especially about the PC emulator, as I need to do project work at home.

**Nick Lewis**

*There are two sorts of emulator, software and hardware, and each has its own distinct advantages and disadvantages. Software emulators are usually quite cheap but, because they have to use the Amiga's operating system to create a total PC environment, tend to be slow, prone to fall over and unwilling to run a great deal of PC software. The most popular of these was the Transformer but this was, at best, pretty bad. It most certainly won't run some of the software that you need to run.*

*Hardware emulators have been around on the A2000 for some time with both PC/XT and PC/AT 'Bridgeboard' emulation perfectly possible. A hardware emulator is essentially a complete PC on a circuit board that connects to your Amiga and uses the disk drives and display of the Amiga to become a stand-alone PC. Software compatibility isn't so much of a problem as the dedicated board copes with most*

**DISK DOCTOR**

I thought that you might like to pass on some information that I have gleaned about the BGS virus.

As most people should know by now, not all viruses live in the bootblock. Some now hit files. One virus will give you a software error because it affects the start-up of the disk.

The BGS virus works like this. Having put an infected disk in the computer, the virus writes itself to RAM as normal. Where it differs from other viruses is that it reads the first command of the startup sequence of any disks inserted thereafter. This can be anything from ADDBUFFERS to a game.

The virus renames that command to a load of spaces and moves it to the DEVS directory. If

there is no DEVS, it usually puts it at the end of the disk.

It then renames itself to that command name, but the byte count will always be 2608.

To take an example. The Workbench1.3 disk has ADDBUFFERS DFO: 10 as its first command in the start-up sequence. You can find ADDBUFFERS in the C directory.

On an infected disk, you will find the following. You get software error. Switch off and load UTILMASTER, CLI-MATE or similar. Check the S/Startup sequence and you will see that addbuffers is the first command. Go to the DEVS directory and you should see a blank line with a byte count at the end. (On my disk it is 876.) That is the ADDBUFFERS

**2 - 4 - 6 - 8 - EMULATE**

*A hardware emulator is an expensive beastie with some of the whizzy AT ones for the B2000 tipping the scales at a healthy four-figure sum.*

*You'll be pleased to know that Bitcon are selling a rather neat XT board for the A500 that goes in the memory slot underneath and comes with a stack of slots to upgrade the Amiga to 1.5Mb of memory as well.*

*No spanners, welding or soldering, just send £320 to Bitcon (yes, it is expensive but you do get a lot for your cash) and look forward to running Next Base Autoroute on your Amiga. That'll tell you where to go!*

*Specification includes:*

- 1Mb RAM slots for upgrade
- All three out of Mono, Hercules and CGA graphics modes

- Supports 3.5 internal, 3.5 external and 5.25 external drives.
- Hard Drive support in the pipeline
- MS DOS 4.01
- Will run through TV as well as through a monitor.

*When you've saved up your cash, Bitcon is on 091 490 1919.*

*For your PD cross Assembler there are several PD libraries advertising in Format who may be able to help you. Here's a list to save you from having to look.*

- Advantage 0242 224340
- UK Amiga User Group 0533 510066
- Softville PD 0705 266509
- Nova PD 0295 62029
- George Thompson 0770 82234
- Amiga PD 0742 750623
- Capricorn 021-707 0381
- Demon 0279 842675
- 17 Bit 0924 366982

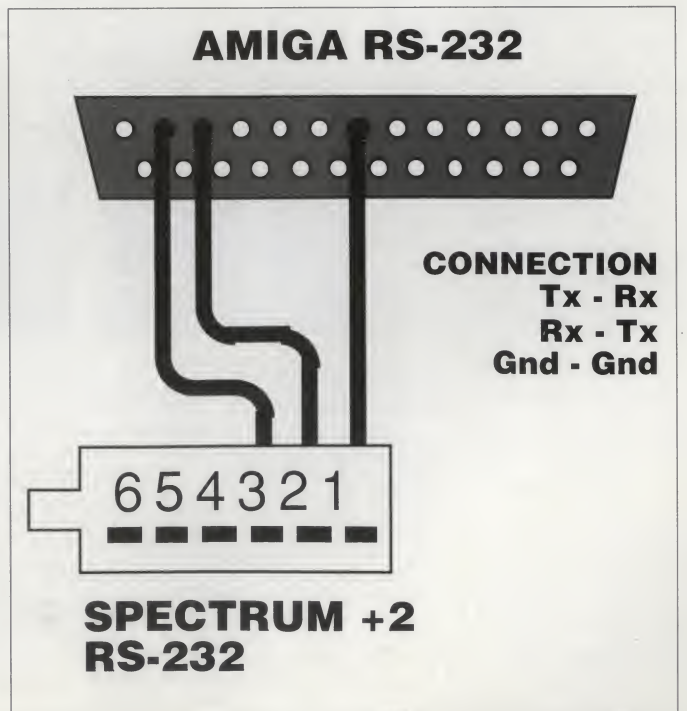

command renamed and moved. Go to the C directory and look at ADDBUFFERS. It will have a byte count of 2608. delete this line. It is the virus and will always have a byte count of 2608.

You now face a choice. Either delete the blank line in DEVs and copy ADDBUFFERS from another disk in the C directory or rename the line in DEVs to addbuffers and move it into the C directory. Remember that the blank line has spaces written to it, it is not empty and that it is the original ADDBUFFERS command renamed.

On disks that have no DEVs directory, just search for a blank line, and the number 2608. Also, remember that the command has been renamed and moved and that it may not have come from the C.Directory.

**Phil Jarvis (of Team Gyton)**

Thanks for an informative letter. The majority of us tend to rely on the excellent vaccine killers like VirusX and Killvirus so it certainly makes a pleasant change to see someone rolling up their sleeves and wading right in.

Your letter makes a good model for a technical subject explained in terms that the average man can understand. We'll look forward to more of the same.

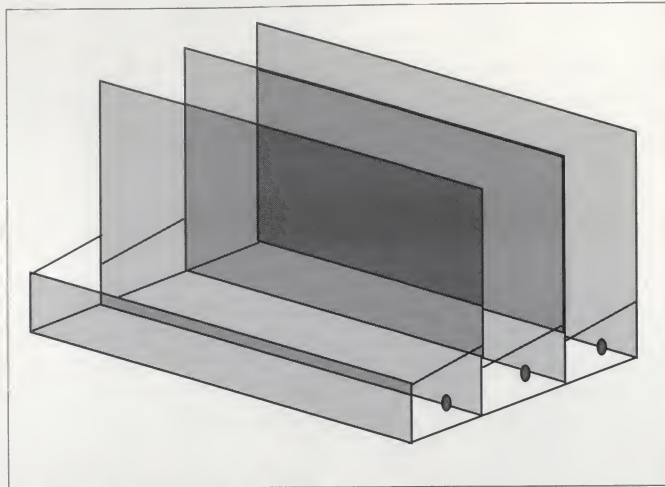

**A simple way to create your own disk storage!**

**TAKE ME FOR A DRIVE**

I own an Amiga 500. After a couple of years of faithful service, the disk drive seems to have b\*\*\*ered up (I think he means 'sadly, malfunctioned' - Ed). I have been trying to obtain a replacement since December without the slightest hint of success.

Phoning Commodore direct was a waste of time as they won't sell spares to the public. They gave me details of local shops who deal with them, but they refuse to order one or don't know what I'm talking about. With previous computers, I've had no

trouble obtaining spare bits and pieces directly from manufacturers. I turn to you for inspiration. You must know where I can get an internal drive. I don't care where the supplier is, just tell me.

Firstly, although your machine is well over a year old and past the stage where a warranty has any meaning, it isn't a particularly good idea to go digging inside your Amiga unless you really know what you're doing.

Assuming that you're a competent computer fixer, the disk drive that you so eagerly seek is

available from DATAPLEX on 0753 35557. As well as supplying you the drive for £63.00 including VAT and delivery, they'll also let you pay with a credit card. What a splendid bunch of chaps. If you want to write to them they're at 10, Petersfield Avenue, Slough, Berkshire, SL2 5DN.

**GETTING IT TAPED**

I have a small cost-saving idea which I would like to pass on. Collect empty tape cassette boxes, separate the lid from the box, stick three of the lids together and hey presto, you are the proud owner of a disk park with three sections, each of which will hold four disks.

What does one do with the left-overs? Send them to the sellers of high-priced disk containers!

**FM Phillips**

And an excellent idea it is too. After scouting round the house I found several cassette cases and as well as utilising your splendid idea added one of my own. Take the first lid and drill a couple of small holes in it. Attach this to the wall. Then glue the other lids on using an impact adhesive such as 'Superglue'. You now have a cheap and cheerful alternative to the plonkerbox.

# LOOK!

ALL PRICES INCLUDE VAT & 1ST CLASS DELIVERY  
☎ 081-744 3087/1834 (Mon-Sat 10-6)



AMIGA BOOKS	
Advanced Amiga BASIC.....	£17.95
Amiga 3D Graphics Prog BASIC.....	£17.45
Amiga Applications.....	£15.95
Amiga Assembly Lang Prog.....	£13.45
Amiga BASIC Inside & Out.....	£17.95
Amiga C Advanced Programmers.....	£31.45
Amiga C For Beginners.....	£17.45
Amiga DOS.....	£13.95
Amiga DOS Inside & Out.....	£17.45
Amiga DOS Manual.....	£21.95
Amiga DOS Quick Reference.....	£7.95
Amiga DOS Ref Guide.....	£13.95
Amiga DOS Inside & Out.....	£17.45
Amiga For Beginners.....	£11.95
Amiga Gd Graphics Sound Teleco.....	£16.45
Amiga Handbook.....	£14.95
Amiga Hardware Ref Manual.....	£20.95
Amiga Machine Lang Guide.....	£20.95
Amiga Machine Language.....	£13.95
Amiga Microsoft BASIC Prog Gde.....	£17.45
Amiga Prog Handbook Vol 1.....	£22.95
Amiga Prog Handbook Vol 2.....	£22.95
Amiga Programmers Guide.....	£16.45
Amiga Programmers Guide.....	£17.45
Amiga ROM Kernel Ref Man Autod.....	£27.95
Amiga ROM Kernel Ref Man Lib.....	£31.95
Amiga Systems Programmers Guide.....	£31.95
Amiga Tricks & Tips.....	£13.95
Becoming an Amiga Artist.....	£17.45
Beginners Guide to the Amiga.....	£15.95
Compute's 1st Book of Amiga.....	£15.95
Compute's 2nd Book of Amiga.....	£15.95
Elementary Amiga BASIC.....	£13.95
Inside Amiga Graphics.....	£15.95
Inside the Amiga with C 2nd Ed.....	£19.95
Kickstart Guide to the Amiga.....	£12.95
Kids & The Amiga.....	£14.95
More Tips & Tricks For Amiga.....	£17.45
Programmers Guide to the Amiga.....	£22.95
Amiga Graphics Inside & Out.....	£31.45

RIBBONS · HIGHEST QUALITY GUARANTEED · F-FABRIC C-CARBON MULTI-STRIKE					
	1+	3+		1+	3+
<b>AMSTRAD</b>			<b>CENTRONIC</b>		
DMP2000/3000 (F).....	£3.50	£3.00	GLP, HP80, 156 (F).....	£3.95	£3.50
DMP3160/3250 (F).....	£3.50	£3.00	<b>COMMODORE</b>		
DMP4000 (F).....	£5.45	£5.00	MPS801 (F).....	£3.95	£3.50
LQ3600 (F).....	£3.45	£3.50	MPS802, 2022 (F).....	£3.95	£3.50
LQ3600 (C).....	£3.75	£3.50	MPS803 (F).....	£3.95	£3.50
LQ5000 (F).....	£8.95	£8.50	<b>DIABLO</b>		
<b>BROTHER</b>			HT11, 1345, 1355 (F).....	£3.95	£3.50
HR15/20/10/25/35 (F).....	£3.95	£3.50	HT11, 3000, 3200 (C).....	£3.95	£3.50
HR15/20/10/25/35 (C).....	£3.95	£3.50	<b>EPSON</b>		
M1009/1109 (F).....	£3.95	£3.50	LX80/86/90 (F).....	£3.95	£3.50
M1409 (F).....	£4.95	£4.50	LX80/LQ600/800/850 (F).....	£4.45	£4.00
M1609/1709/1724 (F).....	£4.95	£4.50	MX80/FX80/85/86/90 (F).....	£3.95	£3.50
<b>CANON</b>			MX100/FX100/LX1000 (F).....	£4.95	£4.50
A1250/40/AP1200 (F).....	£3.95	£3.50	LQ1000/1050/ERC-20 (F).....	£4.95	£4.50
PW1090/PW1156.....	£3.95	£3.50	LQ2500/EX800/3X1000.....	£5.45	£5.00
<b>CITIZEN</b>			(13mm) (F).....	£5.45	£5.00
1200 (F).....	£3.95	£3.50	LQ1500/LP1500 (F).....	£5.45	£5.00
180E (F).....	£3.95	£3.50			
<b>JUKI</b>			<b>QUME</b>		
6100 (C).....	£2.95	£2.50	Sprint 3/5 1,11,111 (F).....	£4.95	£4.50
6200, 6300, 6500 (C).....	£3.95	£3.50	Sprint 3/5 1,11,111 (C).....	£4.95	£4.50
<b>M. TALLY</b>			Sprint 7/9 10/11/14.IV(F).....	£4.95	£4.50
M180/Spirit (F).....	£3.95	£3.50	Sprint 7/9 10/11/14.IV(C).....	£4.95	£4.50
M180/Spirit (C).....	£3.95	£3.50	<b>SEIKOSHA</b>		
MT88/88 (F).....	£5.45	£5.00	CP80 (F).....	£3.95	£3.50
<b>NEC</b>			CP100/250X (F).....	£3.95	£3.50
P2200 (F).....	£4.45	£4.00	<b>SHINWA</b>		
PC8023 (F).....	£4.45	£4.00	CP80/808/CTI (F).....	£3.95	£3.50
Pinwriter P3/P7.....	£5.95	£5.50	CP80/808/CTI (C).....	£3.95	£3.50
Pinwriter P5/9XL (F).....	£5.95	£5.50	<b>STAR</b>		
P6 + P7 (F).....	£5.95	£5.50	LC10 (F).....	£3.95	£3.50
<b>PANASONIC</b>			LC24.10 (F).....	£4.45	£4.00
KXP109/108/1124/159(F).....	£3.95	£3.50	NB15/24-16 (F).....	£4.45	£4.00
KXP3131/3151 (F).....	£3.95	£3.50	NB24.10/ND10/NL10 (F).....	£4.45	£4.00
<b>QUENDATA</b>			<b>TAXANKAGA</b>		
DMP310/DP80/100 (F).....	£4.50	£4.00	810/815/910/915 (F).....	£3.95	£3.50

**DUST COVERS**  
Keyboard.....£3.95  
Monitor (Philips).....£9.95  
CM8833 (Commodore 1084)

**3 1/2" Disc Drive Head Cleaning Kit**  
£3.95

**AMIGA A501 RAM £85.95**  
COMMODORE ORIGINAL CLOCK & CALENDAR

**CABLE & CONNECTORS**

MONITOR LEAD (D23F - SCART).....	£14.95
PRINTER CABLE PARALLEL (D25M CEN36M).....	£7.95
NULL MODEM CABLE (D25 mm, MF, FF).....	£14.95
D23 M OR F WITH COVER.....	£3.95
7 CORE SCREENED CABLE (PERM).....	£2.00
SCART 21 PLUGS.....	£2.00
TWIN PHONE PLUG WITH CABLE (1M).....	£2.00

AMIGA MOUSE.....	£24.95
AMIGA CONTRIVER MOUSE.....	£22.95
MOUSE MAT: THICK RUBBER.....	£4.95

**LOCKABLE DISC BOXES**

3 1/2" 50 (CAPS).....	£7.95
3 1/2" 80 (CAPS).....	£9.95
3 1/2" 80 (CAPS, STACKABLE, DRAWER TYPE) BANX BOX.....	£9.95

**EXTERNAL DISK DRIVE**

NEC/TEAC/CITIZEN.....	£65.00
-----------------------	--------

**JOYSTICKS**

COMPETITION PRO.....	£13.95
COMPETITION PRO EXTRA.....	£15.95
QUICK JOY JET FIGHTER.....	£12.95
SPEED KING (WITH AUTO FIRE).....	£12.95

DISK	3.5" Maxell Sony 3M		100% CERTIFIED (prices for pack of 10 labels and envelopes)	
	Dysan Verbatim		BULK	
	DSDD 720K	DSHD 1.4M	DSDD 720K	DSHD 1.4M
10	£9.50	£23.95	£5.50	£12.95
20	£17.95	£43.95	£10.50	£23.95
30	£26.50	£64.95	£15.50	£34.95
40	£34.95	£86.95	£20.50	£46.95
50	£42.50	£107.95	£24.50	£57.95
100	£84.95	£214.95	£47.50	£109.95

\* Prices are for mail order only and subject to change without notice.  
\* Education, Govt. Authority Official Orders welcome (min £50)

orders to: **A to Z Computer Services**  
49 Heath Road, Twickenham, Middlesex TW1 4AZ Fax: 081-891 6260

# POWER COMPUTING

THE AMIGA 2000 SPECIALISTS

SOLE UK DISTRIBUTOR FOR



**68030 POWER**  
FOR YOUR AMIGA 2000

- 16MHz, 28MHz, 33MHz
- Accelerate your Amiga up to 10 times normal speed!
- Up to 8MB High speed 32 bit "nibble" RAM.
- On-board AT interface for lightning fast hard disk access
- Optional 68882 Coprocessor

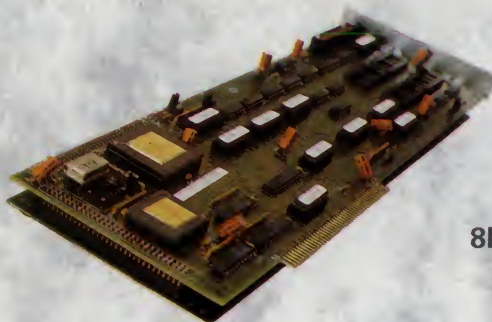

- 68030 ACCELERATOR BOARD
    - 16MHz **£599**
    - 28MHz **£799**
  - 68030 WITH 4MB 32BIT RAM
    - 16MHz **£1595**
    - 28MHz **£1795**
    - 33MHz **£2579**
  - QUANTUM 11ms AT Hard Disk ProDrive™
    - 40MB **£459**
    - 80MB **£839**
- Phone for other combinations

## QUALITY GVP HARD CARDS AT UNBEATABLE PRICES!

- Plug in & Go! Installation
- 20 - 100 MB
- Sockets for 2MB Simm RAM
- Autoboot feature

- 20MB **£399**
- 46MB **£499**
- 60MB **£599**
- 80MB **£699**
- 100MB Quantum **£899**
- 2MBRAM Upgrade **£149**



POWER HOUSE

**SUMMER SPECIAL!**

40MB QUANTUM HARD CARD AT THE INCREDIBLE

PRICE OF

**£479**

INC. VAT

LIMITED OFFER ONLY

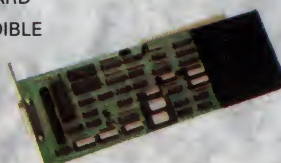

## 8MB EXPANSION BOARDS

with Hard Disk Controller

- Expand up to 8MB with on-board SIMMS ■
- All necessary connections for SCSI Hard Disk Drive ■

- 2MB **£439**
- 4MB **£579**
- 8MB **£869**

## HARD DRIVES

- 46MB Seagate **£329**
- 60MB Seagate **£489**
- 84MB Seagate **£568**
- 100MB Quantum **£799**

## BUY YOUR AMIGA 2000 SYSTEM FROM POWER

Leaders in the Home and Business Market

- Amiga B2000 Rev 6.2
- 1MB RAM
- 20MB Hard Disk

only **£1195**  
INC. VAT



- Amiga B2000 **£399**
- Extra internal floppy **£49**
- 8MB RAM Board with 2MB RAM **£299**
- 2MB UPGRADE FOR THIS SYSTEM **£159.96!****



## MULTISYNC GRAPHICS

Enhance your graphic capability with a flicker fixer and Multisync monitor

- Microway Flicker Fixer **£299**
- Samsung Multisync **£499**
- NEC Multisync 3d **£649**
- NEC Multisync 4d **£1095**



## EASYL 2000

- Pressure Sensitive Drawing Tablet ■
- Draw directly on your computer screen ■
- Using ordinary pen or pencil ■
- 1024x1024 pixel drawing area ■
- Works with all popular software packages ■

- ### VIDTECH SCANLOCK
- STATE OF THE ART AMIGA GENLOCK
- Broadcast quality video output
  - PAL, NTSC, SVHS Compatible
  - Handles all Amiga Graphics modes
  - Completely Eliminates video dot crawl

**£899 INC. VAT.**

Power Computing Ltd • 44a Stanley Street • Bedford • MK41 7RW

**Telephone 0234 273000 • Fax 0234 270133**

Orders and dealers enquiries welcome by Telephone or Fax  
ALL PRICES INCLUDE VAT AND 24 HOUR DELIVERY • PRICES SUBJECT TO CHANGE WITHOUT NOTICE

# PC

# POWER CO

ALL PRICES ON THESE PAGES INCLUDE VAT AND DELIVERY

A selection of special deals only available

**A500 512K EXPANSION**

**A500 1.5MB EXPANSION**

**NOW ONLY £45**  
INC. VAT  
INCLUDING BATTERY BACKED CLOCK

**NOW ANTI CLICK!**

**A500 Internal Drive Kit**

**£49**

**ONLY £59.95**  
INC. VAT  
**Power Drive PC880**

- Now with anti-click that stops that annoying drive click when no disk are present!
- Fully compatible with A500, 880K formatted
- Isolating on-off switch
- Through port for daisy chaining
- Colour matched and styled to Amiga
- Free utility diskette
- 12 month warranty

**DUAL AMIGA DRIVE £99**

**A500 Expansion ram PC501/PC502**

- A500 Expansion Ram using low power 1 Mb chips
- Two Models available 512K/1.5MB
- Complete with clock and lithium battery
- Fits in A500 expansion underneath computer
- Comes complete with extra ram switch off software
- 1.5MB model **only** requires simple cable to be fitted inside Amiga
- 12 month warranty

**40 Disks\* and lockable storage box**

**£29.95**  
INC. VAT

**15 Disks\* and Storage Box**

**£9.95**  
INC. VAT

Verbatim media - fully certified and guaranteed for life!

**GVP IMPACT A500 Hard drive**

Now using SIMMS for a massive 4MB extra ram!

- SCSI 3.5" Hard Disk
- DMA direct to onboard 16KB buffer controller
- Snap on cable connector for reliability
- Autobooting, FFS
- Up to 4MB of fast ram can be added internally
- External SCSI connector
- Dedicated power supply unit
- 12 month warranty

	0K	2MB	4MB
45MB	£599.00	£749.00	£899.00
80MB	£849.00	£999.00	£1149.00
100MB	£999.00	£1149.00	£1299.00

**BUY YOUR A500 SYSTEM FROM POWER AND GET A GREAT DEAL MORE!**

- All in one model
- A500 system
- Basic Amiga Games pack
- Zealand Story and Interceptor Games
- Deluxe Paint 2
- Konix Speed King Joystick
- Mouse Mat
- 5 diskettes

<b>BASIC PACK</b>	as above	<b>£399</b>
<b>SUPER PACK</b>	with PC880 drive	<b>£459</b>
<b>ULTRA PACK</b>	with PC880 + 512K	<b>£499</b>
<b>MEGA PACK</b>	with PC880 + 1.5MB	<b>£599</b>
<b>HYPER PACK</b>	as Mega with A590 Hard Dr.	<b>£949</b>

Class of the 90's and other packs available  
Commodore A590 20MB Hard Disk £379

# COMPUTING

available from Power House DIRECT!

## GO COLOUR AMIGO!

- Includes
- LC10 Colour UK Model
  - Parallel Cable
  - 200 sheets microperf paper
  - 200 address labels
  - LC10 colour WB driver
  - Delivery and vat



LC10 Colour Fabric printing kit  
£24.95

Star LC10 Colour Complete Kit  
**£219.00**

INC. VAT



- Star LC10 Colour £219  
Star XB10-24 Colour £499  
HP Paintjet Colour £799  
HP Paintjet XL A3 Colour £2500

Amiga Music System (MM5000 + Pro Sound Gold) **£99**



Video Magic + P.A.S.E. Animation Program **£49** VIDTECH SCANLOCK **£899**

- Multi media presentation system
- Supports all IFF picture files
- Supports P.A.S.E. Animations
- Auto scripting
- Sound effects by using Prosound Designer
- Controllable from joystick Port 2
- Many more features

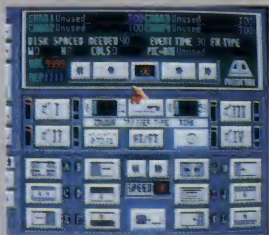

Full details available

All trade marks acknowledged

## The One Stop Software Shop! Callers Welcome!



Power Computing are the productivity software specialists. Scores of new titles every week! The following is a selection from our large range. We also stock most of the published Amiga books and magazines.

### RED HOT PRICES

#### ART & GRAPHICS

Typically 30-40% off rrp

- Animagic £69
- Amiga Clipart £29
- Comic Setter £37.95
- Deluxe Paint 3 £59
- Deluxe Photolab £48
- Deluxe Video 3 £79
- Digipaint 3 £49
- Digiview Gold 4 £109.95



- Elan Performer £39
- Express Paint 3 £69

- |                        |        |                                 |         |
|------------------------|--------|---------------------------------|---------|
| Fantavision            | £29.95 | WORD PROCESSING, DTP & BUSINESS |         |
| Interchange            | £49    | Excellence                      | £159.95 |
| Interfont              | £79    | Home Accounts                   | £24.95  |
| Intro Cad              | £39    | Kind Words                      | £39     |
| Kara Screen Fonts 1    | £49    | Maxiplan +                      | £99     |
| Kara Screen Fonts 2    | £49    | Maxiplan 500                    | £79     |
| Movie Setter           | £48    | Pagestream                      | £120    |
| Photon Paint 2         | £79.95 | Pro Draw                        | £100    |
| Pixmate                | £35    | Pro Page 1.3                    | £179    |
| Pro Video Plus PAL     | £169   | Pro Page Templates              | £39     |
| Sculpt 3D XL           | £99    | Pro Text                        | £74.99  |
| Sculpt 4D Junior       | £149   | Pen Pal                         | £99     |
| Sculpt 4D              | £329   | Superbase 2                     | £62     |
| Turbo Silver           | £99    | Superbase Pro                   | £160    |
| Video Magic + P.A.S.E. | £49    | Superplan                       | £62     |
| Video Page             | £99    | The Works Platinum              | £149    |
| XCAD Designer          | £87.95 | Word Perfect                    | £164    |
| XCAD Pro               | £325   |                                 |         |

#### LANGUAGES ETC

- Devpac Amiga £45
- Hisoft Basic £55
- Lattice C v5 £160
- Lattice C++ £299
- Manx C Dev £163
- Manx Debugger £49
- Power Windows 2.5 £48
- UTILITIES
- ArexX £39

- BAD £35
- BBC Emulator £39
- CLImate £20
- Dos 2 Dos £29
- Cross Dos £29
- Fine Print £39
- Quarterback £34
- Transformer £29
- WB 1.3 £15



- MUSIC
- Midi Interface £25
- C64 Music Keyboard Interface £49
- MM5000 Keyboard £55
- Dr T's Drums £25
- Dr T's Midi Studio £49
- KCS level 2 £229
- Music X £199
- Pro Sound Gold £39
- Amiga Music System £99
- Sonix £45

Need Help?  
Power Technical Helpline Mon-Fri 3pm-5pm 0234-273248 Customers only!  
For sales information call our sales lines! All prices are subject to change  
Availability on most items is excellent due to large stocks. Please call first to avoid disappointment

**POWER**  
**HOUSE DIRECT**  
**GVP**  
NATIONAL DISTRIBUTOR

Power House, the direct sales arm of Power Computing Ltd — Leaders in peripherals & software — is the natural choice for the Amiga enthusiast. Highly competitive prices, a wide choice, fast computerised service and the backing of a £2M+ 5 year old company are just some of the reasons for tele-shopping at Power. Large stocks, friendly reception and "if it don't work we give you a new one" are a few more!



"The Extensive Power House Bedford Showroom" open Monday to Saturday 9.30am - 6.00pm Thursday & Friday 7.00pm

Power Computing Ltd,  
Power House, 44A Stanley Street,  
Bedford MK41 7RW

Orders Only 0800 581742 Free Call  
General Enquiries & Orders  
0234 273000 (5 lines)

Name

Address

Postcode

Telephone

System owned

Credit Card no.

Expiry date

Signature

I would like to order

Make cheques payable to  
Power Computing Ltd

I enclose a cheque / PO for

£





**SPECIAL K**

I don't understand quite where the discrepancy of 21,120 bytes has gone on my Amiga disks. According to documentation, when I format a disk in drive DF0 there should be 901,120 characters of storage available and yet, no matter how hard I try 880K is the maximum that anyone will confirm as the storage available on a disk. I assume that 880K means 880 x 1000 (if it doesn't, then why not?) and this adds up to 880,000.

We even looked in the disk drive to see if there was anything blocking it or shaving off bits of storage but to no avail.

**Jeff Blomstein-Bhot  
Pudsey, W Yorks**

*Ergggg, you are geting your kilo-meters, kilograms and kilobytes mixed up.*

Most things are based on human (analogue) concepts that work in the base of ten (decimal) This is convenient for humans as we have ten fingers and toes (not so good for three-toed sloths though - Ed). Computers, however, work in the binary (base of two) thus meaning that they count 2,4,8,16,32,64 and so on. The closest they get to 1000 is 1024, which is two raised to the exponential power of ten.

1024 is known as a kilobyte. A quick trip across the keys of Casio's patent 'elektrik abacus and counting engine' confirmed that 1024 multiplied by 880 does indeed equal 901,120 thus solving the maddening mystery of the missing kilobytes.

**VENI VIDEO VICI**

I tried to use the graphics power and capability of my A500 to produce pretty titles for the family's home videos but it didn't work. I took the video output from the A500 and tried to 'combine' it with the output of my camcorder

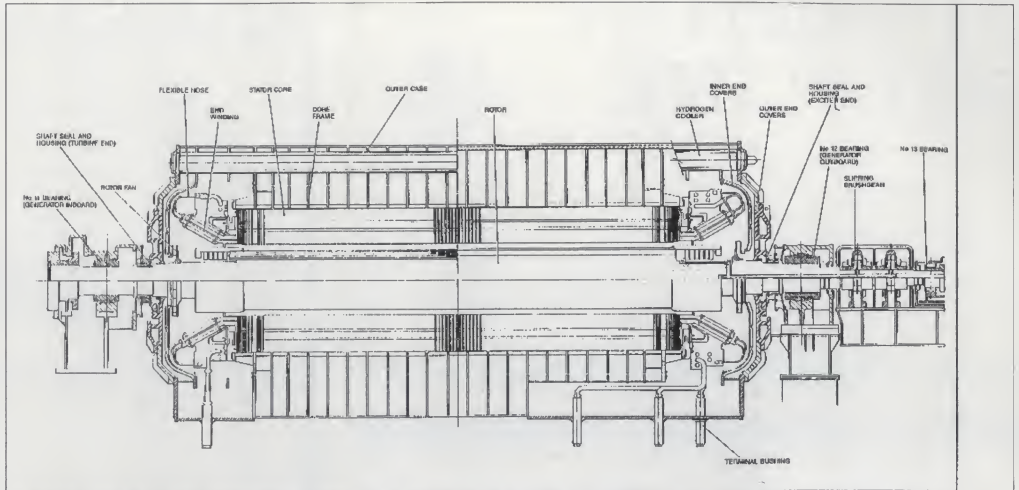

**A quick trip into the thundering heart of a generatorturbinefrillibulator confirms Aaron's suspicions...**

and record it onto the home video recorder.

Firstly I spliced the leads from the camcorder and A500 together and then further combined it into my ferguson 3V23 video recorder. The result... alternate garbage and nothing. this doesn't make sense as all of the equipment uses PAL and operates the same system. What should I do?

**Veronica Madeley  
Scunthorpe**

The first thing that you should do is dismantle your composite hybrid spliced lead and firmly promise never to try that again. You run the risk of killing your A500, camcorder and video.

if you wish to put professional looking computer generated titles on your videos, you'll need a device called a genlock. This takes the incoming signal from your video source and makes it compatible with your computer generated signal. once this is done, the signals can be combined and manipulated using hard and software to produce some pretty stunning results.

Genlocks come in many shapes and prices with a cheap

domestic one weighing in at about £100. This may be adequate for your purposes. If you wish a more professional result, you can spend thousands of pounds on a broadcast quality rack-mounted genlock.

If you would be satisfied with the captions on your videos coming between the visuals (like in the old silent films) instead of over the top of the, you could probably tune a spare channel of your video into the output frequency of the Amiga TV modulator and alternately record captions and live video.

The second option would be a little untidy but a lot cheaper and a lot less fuss.

**AARON'S ROCK**

I am hoping to emigrate to Australia next year and I would like to take my trusty Amiga 500 with me but there's only one slight problem. Will it work on the standard Australian electricity supply of 240 volts AC, 50 hertz? If the answer is no, is there anyway of converting the computer to run at that supply?

Also, does the Philips CM8833 or the Commodore 1084-D/S take its power supply directly from the Amiga?

**Aaron Elridge**

A hurried call to National Power and Powergen confirmed my worst suspicions. In a bid to rid the country of Aaron Elridge for once and for all, they've cunningly adopted exactly the same electrical standards as the Australians. How fiendishly clevr can you get?

Hardly able to believe your luck, I visited Grid Control, and the men who run the National Grid showed me a small three-pin socket - identical to those in my own home - from which was flowing a current of pure 240 volts at 50 cycles 3 phase, the ideal food for your Amiga. In the meantime, the two monitors that you

mention don't draw their power from the Amiga, but from their own mains plug.

**LEAD LEAD**

I want to make up some leads to plug my Amiga into an industrial high-resolution monitor at work. The problem isn't one of compatibility but of sourcing. I have checked with Commodore UK and the makers of the monitor and the two machines are compatible. I have even persuaded the two to exchange signals by cutting up a 25-way connector and bodging a plug together.

As the Amiga is to be used for professional purposes, where can I get a 23-pin Amiga video plug from?

**Johann Puntby  
Derby**

Try Paul Simpson of The Shack. He has just about every plug, twid- get and fixture under the sun and can be contacted on 0332 760353 between 1100 and 2000.

**MORE MEGABYTES**

I need to upgrade my A500 to 2 Megabytes of memory but cannot hang it on the main expansion port as peripherals that I already have on there don't allow for extra memory.

The documentation with them says that extra memory must be put in the slot underneath. Is there a way of connecting a ribbon cable to this slot and putting a larger capacity memory board somewhere outside the machine, or must I suffer in a meagre megabyte of memory?

There's really is no need at all for the ribbon cable idea as there are already plenty of boards that go in the slot underneath that will happily take 1.5 Mb. This quite cheerfully makes the 2 Mb you need when added to the 512K already in your A500.

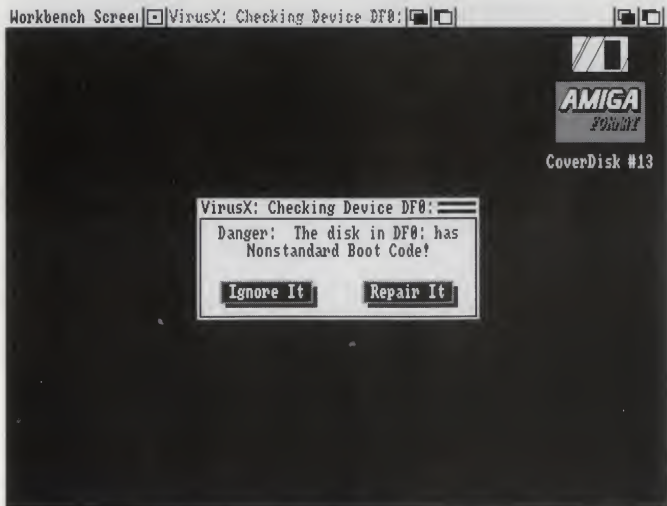

**The very virus-busting program referred to in DISK DOCTOR, P 147.**

# ADVENTURE HELPLINE

Do you play computer adventures? Have you ever been faced with a seemingly impossible situation?

**WE CAN HELP**

Our adventure rescue team work 7 days and 7 evenings a week and will be pleased to answer your queries. We offer help with any games or any computer - so if you are tearing your hair out ring this number NOW!

**0898 338 933**

T.M.E Plc 10b Hulme Hall Road, Manchester M15 4LY

Calls charged at 25p min "cheap" rate/38p at all other times



# TELETEXT

A world of information at your fingertips



Now you can keep it informed with the latest weather, financial news, sports results, current affairs and much more from Ceefax or Oracle. But unlike a Teletext TV all this valuable information isn't trapped behind glass. Now you can.....

**Save to disc.** Pages may be saved in Compact (over 800 pages per disc) or IFF format.

**Print.** You can print as just text (for a fast result) or as a screendump.

**Review.** Instant access to the last 16 pages which have been received.

**Speak.** Thanks to the Amiga's speech capability, it will even read the news to you.

**Multiple display.** It can display and update two pages on screen simultaneously!

**FastText.** True FastText - gets pages in advance and reduces the waiting time.

**Tuning.** Just connect an aerial - it tunes itself in! Although the prime function is to receive Teletext, it also will convert a 1081 or 1084 monitor to a colour TV.

**Programmable.** The system can be programmed to get a series of pages and then save or print them. Your own programs can access the data on Teletext.

Only a Microtext adaptor can provide all these facilities, it's easy to use and connects to the parallel port, a printer can be reconnected to the adaptor. Everything is supplied, all you need is your Amiga and a normal TV aerial.

At just £124.80 + VAT inc p/p for an advanced Teletext TV it's excellent value for money. Make sure you're always up to date, and get yours now from:-

**MICROTEXT**

Dept AF, 7 Birdlip Close, Horndean, Hants PO8 9PW  
Telephone: 0705 595694 Fax: 0705 593988

# COMPUTACHAT

Are you a computer games player, programmer, musician or artist?

Would you like to talk to others like you to swap hints, tips, pokes or even software (must be originals or PD).

Are you interested in forming a group to buy blank disks or cassettes in bulk or would you just like to chat in general about computer orientated activities.

**RING COMPUTACHAT ON  
0898 338939**

EXPERTS ON HAND TO ANSWER ADVENTURE QUERIES

TME PLC, Box 54, South West Manchester M15  
Calls charged at 25p/min "cheap" rate - 38p at all other times



## ADVANTAGE

# THE AMIGA ADVANTAGE

**POPULAR PD SOFTWARE IN SPECIAL 3-DISC PACKS**

PRICES INCLUDE VAT & POSTAGE

## FOUR WAYS TO BUY:-

- 1 PHONE 0242 224 340 with your Access or Visa no.
- 2 FAX 0242 226 755
- 3 POST your cheque or P.O to 56 Bath Road, Cheltenham
- 4 COLLECT from our showrooms

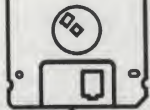

### MIDI ROLAND'S NEW DESK-TOP COMPUTER RANGE

#### CM-64 LA/PCM

The CM-64 LA/PCM Sound Module gives a maximum of 63-voice polyphony, is 15-part multi-timbral (including rhythm part) for full orchestral reproductions and provides 64 PCM preset tones and, from the wonderful world of LA synthesis, 128 synthesizer presets, 30 percussion sounds plus 33 sound effects for the rhythm part. The CM-64 also accepts U-110 sound sample library cards and incorporates an on-board digital reverb.



£789

#### CM-32 LA

The CM-32 LA Sound Module provides all the LA capabilities of the CM-64, is 32-voice polyphonic and 9-part multi-timbral and likewise has built-in digital reverb. The CM-32 PCM Sound Module contains the CM-64's PCM section with its 64 presets, is 31-voice polyphonic and 6-part multi-timbral, has the same digital reverb, and is U-110 sound-card compatible.



£445

### VISIT OUR SHOWROOMS



£129

#### CF-10

Next in the range comes the CF-10 Digital Fader. This is an easy-to-use mixing controller with the feel of an analogue audio mixer and featuring 10 multiple MIDI channels, designed to mix song data for sequences created on PC or MIDI sequencer. It also enables control change messages of volume and panning to be transmitted to external MIDI devices.

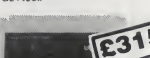

£315

#### CN-20

The CN-20 Music Entry Pad facilitates the programming of basic song data on a PC. It offers, for instance, easy editing of data pre-recorded from an external keyboard in real time. Its multi-purpose fader can be assigned to control a variety of MIDI information such as Control Change Bender and Aftertouch over any of the 16 MIDI channels.

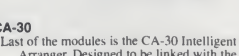

£129

#### CA-30

Last of the modules is the CA-30 Intelligent Arranger. Designed to be linked with the CM-64 or CM 32-L, the CA-30 is a sophisticated auto arranger with similar intelligent arranging functions as found on Roland's best-selling E-20 Intelligent Synthesizer. With the CA-30, even complete beginners can create interesting and convincing song data.

ASK ABOUT OUR SPECIAL OFFERS

### NEW LOW COST AMIGA-PACKS

23 compilation packs for AMIGA computers. Each contains three discs full of popular, tried and tested PD programs.

★ **AMIGA CLASSICS** Space Invaders, PacMan, 3D-Breakout, Bally II, Wanderer, Egyptian Run, Light Cycles, Mirror Wars, Battleships, Lander.

★ **AMIGA CHALLENGER** Chess, Solitaire, Backgammon, Empire, OXO, Multi-Level TicTacToe, Picture Puzzle, Othello, Klondike, Tetrix, Monopoly, Shanghai, Five In A Line, NutHouse, Yahtzee.

★ **AMIGA ADVENTURES** featuring Hack, Lam Dungeons & Dragons, Moira. (Moirra needs 1M).

★ **FUN WITH GRAPHICS** featuring Animation, Mandelbrot Pictures, CAD, Fractal Landscapes, Graphics, Raytracer, Sliding Puzzle, Life 3D.

★ **STAR TREK** Amazing new version of this cult classic. Needs two drives and 1 Meg memory. Playable demo with great graphics and sound.

★ **THE MUSIC PACK** A large collection of sound effects, new instruments for the CZ synths, MIDI utilities and songs.

★ **SOUNDTRACKER** Make your Amiga more musical with this high quality program. Includes full instructions, songs and instruments.

★ **SONIX** Three disc-fulls of tunes for the commercial Sonix program.

★ **KERMIT & FRIENDS** A selection of communications programs including Kermit himself.

★ **UTILITIES TOOLBOX** A host of useful utilities for the Amiga user.

★ **HACKERS TOOLBOX** Sector Editors, Archivers, Virus Killers etc.

★ **LEARNING C** A complete C compiler plus loads of tools and source code.

★ **THE PROGRAMMERS PACK** featuring Prolog, Forth, Modula-2, Lisp, Logo.

★ **SEEING STARS** A collection of fascinating Astronomy programs.

★ **WORD PROCESSING** Complete WP system - Spelling Checker and Editor, Printer and Text Utilities

★ **HOME & BUSINESS** featuring Database, Spreadsheet, Home Accounts, Hypertext Shell, Calculator, Home Inventory.

★ **THE DEMO PACK #1** The latest top quality demo programs.

★ **THE DEMO PACK #2** Popular demo classics.

★ **THE DEMO PACK #3** A selection of entertaining Music Demos.

★ **THE DEMO PACK #4** A further set of musical demos.

★ **PICTURE SHOW #1** High quality slide-show of hi-res pictures.

★ **PICTURE SHOW #2** More hi-res pictures to see for yourself.

ONE PACK.....£9.95  
TWO PACKS.....£15.95  
THREE PACKS.....£21.95  
OVER THREE PACKS.....£7.50 each

**ADVANTAGE (AF) 56 BATH ROAD CHELTENHAM GL53 7HJ. TEL 0242 224340. FAX 0242 226755.**

**CHAMPIONS OF KRYNN**

You've donned your armour, given yourself a ridiculous *nom-de-plume* and sat yourself down in front of your Amiga to set forth on your quest, only to fall foul of the first creature you meet. Don't despair - here are some hints along with a couple of lovely maps to help you on your way.

**CHARACTERS**

To achieve any level of success you really need to operate as a knight. The best combination of characters is usually Fighter, Knight, Ranger, Cleric, Red Mage and White Mage. When you first create a character choose the best armour class, as all the other attributes can be modified on the main screen, including hit points.

**THROTL TOWN**

The Commandant at the outpost will request you to go to Throtl to save Camaron. Go to the town and head towards number (1) on the map, which is where Camaron is to be found. Beware of the first person you meet, since he's a spy. When he asks to join your band, show him the respect he deserves and attack him. Once he is out of the way you can head off towards Camaron, allowing anyone else who wishes to join to tag along.

When you find Camaron, he will tell you that you need to get a key, which is found at position (2). Once you have found the map, head up the main passage until you find the 'secret' passage. Go through and head for the temple located at position (3). Take out any hostile creatures you may encounter and head towards position (4) which is where you will find the stairs to the second level.

**THE OGRE'S BASE**

As soon as you enter the tomb, turn right and enter the first door on the right. Here you will receive some useful information. Always

# GAME BUSTERS

The summer months are upon us! Pop festivals are coming, the sea is calling and that weather is far too nice to ignore. But this last level is causing so many problems... Never mind! **MAFF EVANS**, the man with a map and a smile for every honest gamer, has a hatful of tips for all you despairing people.



The letter you should have will corroborate your story, so they will consider you allies and join you for the big fight. Shouldn't do any harm to have such weight behind your ranks!

**CARAVAN**

Buy and ready the weapons you need and set off. Head towards Throtl and you will come across a caravan that is under attack from Draconions. Attack the marauders using magic whenever possible.

Once you have achieved a stunning victory, you will be asked to escort the woman back to the outpost. Agree to the task and once inside the outpost visit the hall to train your characters. Once

try to be polite and greet any ogres you meet. The first few will attack you anyway, but don't get disheartened, as all the ogres will greet you afterwards.

Explore the camp thoroughly using the map and once you've checked everywhere go to the ogres' meeting at position (1). When they ask you, tell them about the assassins.

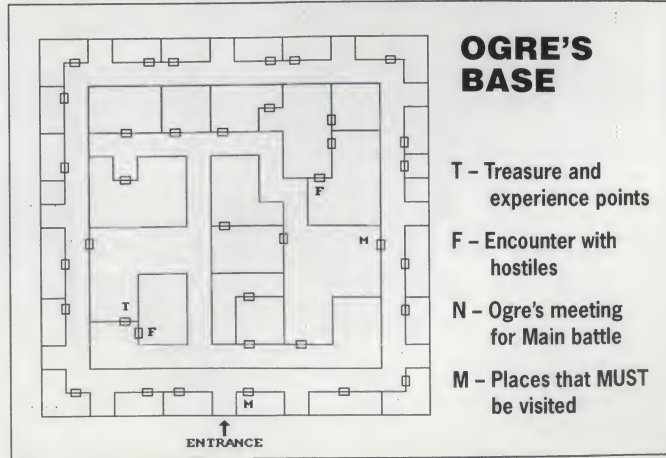
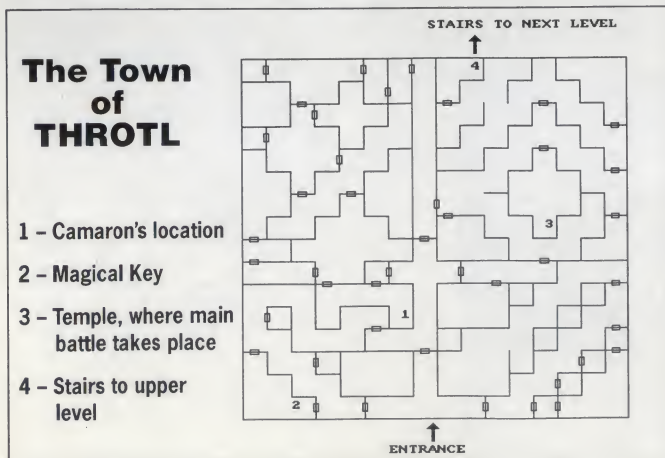

your team has worked up enough of a sweat, it is time to go and visit the Commandant.

**THE TOMB**

Once all the training has been done and you've seen the Commandant, leave the outpost and head North-West where you will find the tomb.

Enter the tomb and undertake the tests of honour, fear and battle. Once you have completed the final test, you can leave the tomb. Watch out though, as you will meet and have to do battle with some Draconions.

The hardest test you will be confronted by is the battle test. Always use the Knight for the tests and act as a true Knight does, taking the honourable option every time. For example, when you find the treasure room, don't try to steal anything!

The test of fear is simple. All you have to do is walk into the fire-rings. Don't worry even if your hit points are down to one, as you will be healed after the test.

Maps and hints sent in by Gandalf and Waz (?), Ringwood, Hampshire

**TOWER OF BABEL COVERDISK DEMO**

Talk about being thrown in the deep end (Okay - being thrown in at the deep end is an interesting expression, meaning either placed instantly in a difficult situation, or alternatively, taking it's more literal connotations... OH SHUT UP!), the Coverdisk demo of Microprose's superb 3D puzzle game was a tad on the difficult side. Oh all right it



was damned difficult! However it is possible, and we have the solution to prove it! Just follow these instructions along with the map to achieve success.

Move Zapper North one space to square G1.

Jump to Pusher and move forward two squares to H6 and press fire. The mine will now move to H4, where it can explode safely.

Turn Pusher to face North and press fire. The block in front of you will move forward to block the laser turret at square F8.

Go back to Zapper and move North one space to F1.

Turn Pusher right to face East and move forward one space. Turn left to face North again and press fire. When the block stops sliding, press fire again to move it one square further, so that it protects Zapper by blocking off the next laser turret.

Move Zapper North again and turn right so that it faces East. Move forward five spaces to square E6. Go North one space, then East one space so that you

are on the lift at square D7. Press the up/down button (the one above pause) to ascend on the lift. Turn to the West and press fire to blast the laser turret into pieces.

Switch control to Pusher and move to square H4. Turn to face North and wait for Hopper to bounce into view on the far side of the arena. Fire through the converter on square C4, which will change the push shot to a zap shot to destroy the Hopper.

Switch to Zapper and move to the lift on square E3. Go up the lift and face North. You will see a laser turret in front of you, but DON'T blast it just yet.

Go to Grabber and press the up/down button to go up on the lift. As soon as Grabber starts to rise, switch control to Zapper and press fire to send the turret into a mass of particles. As soon as you've loosed off a shot, switch back to Grabber (who should now be at the top of the lift) and quickly move one space to the West. You will see a glass block moving towards you, but don't worry - it will stop before it crushes you! Turn to face West and press fire to grab the Klondike in front of you. Make an about face to look East and fire to grab another one. Hit the up/down button to descend on the lift and move North one square. Turn to the West and hit fire to grab the last Klondike. And there you have it - the level is complete.

If you have enjoyed this puzzle experience then Tower of Babel is now avai...STOP! That's quite enough of that, thank you VERY much!

Robert Baker, South Chailey, East Sussex

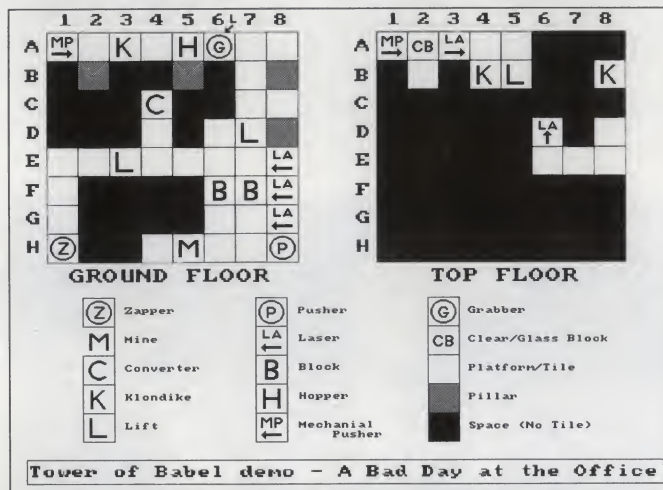

**JUMPING JACK SON**

Having trouble getting through the challenge stages? Well just sit and listen to the music then! Whaddya mean that's not enough? Do you think I've got nothing better to do than sit here telling you how to do every little thing? Oh, all right then, you've talked me into it.

Just have a shuftie at the diagram for the correct path through the first challenge stage. If the others are still causing problems, don't panic. Here are the codes for the higher stages: **Level 5 - ROCKNROLL, Level 9 - NOISES Level 13 - ELVIS.**

Paul at the Computer Shop, Leeds

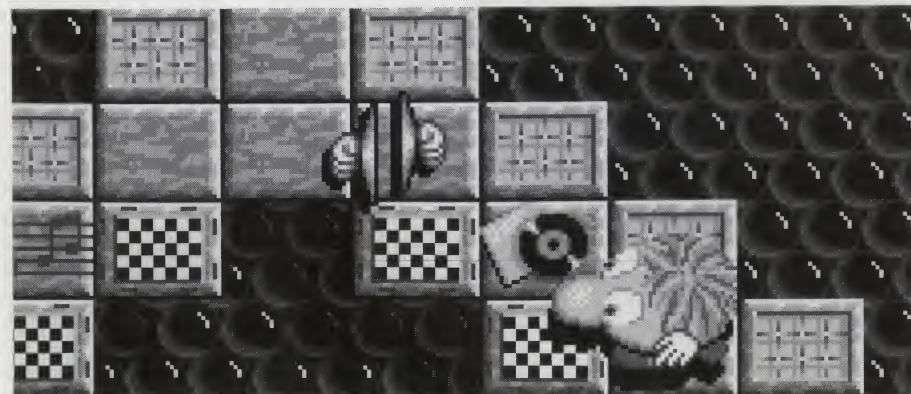

**Challenge Stage One**

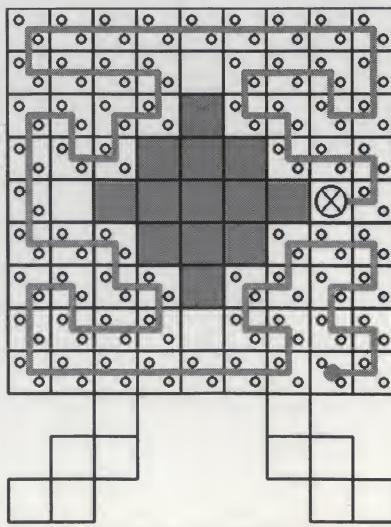

Natural and responsive player movement and with the most simple of one-touch joystick control ensures exciting and authentic soccer action. Realistic close-ball control, computer aided team control and the micro's constant "flow of play" monitoring all add up to make this the easiest yet most rewarding soccer game ever devised for the home computer.

## TAKE ON THE WORLD!

Choose your opponents from the 24 World Championship teams - each have their own styles strengths and idiosyncrasies! You will delight at the on-screen action, realistically flowing animation, automatic team response and the easy to follow con-generated action choices. This game is the choice of all football players, those who love playing the game instead of wrestling with the joystick...

## YOU MAKE THE PLAY!

Pin 'em to the base line, attack the net and volley the winner! You might have taken this match but that was on grass - can you play as well on clay or on the indoor courts?... with TIE-BREAK you'll soon find out! And the play selection doesn't end there - play singles or doubles, select to play in all the major tournaments such as Wimbledon, Davis Cup, French Open and many more. You can then make a racquet selection -and that could win you the match! Featuring all the shots in the book, breathtaking animation and amazingly realistic speech and sound effects in T.V. style presentation make TIE-BREAK the out and out winner on any micro.

AVAILABLE FOR  
SPECTRUM, AMSTRAD,  
COMMODORE, ATARI ST,  
AND AMIGA

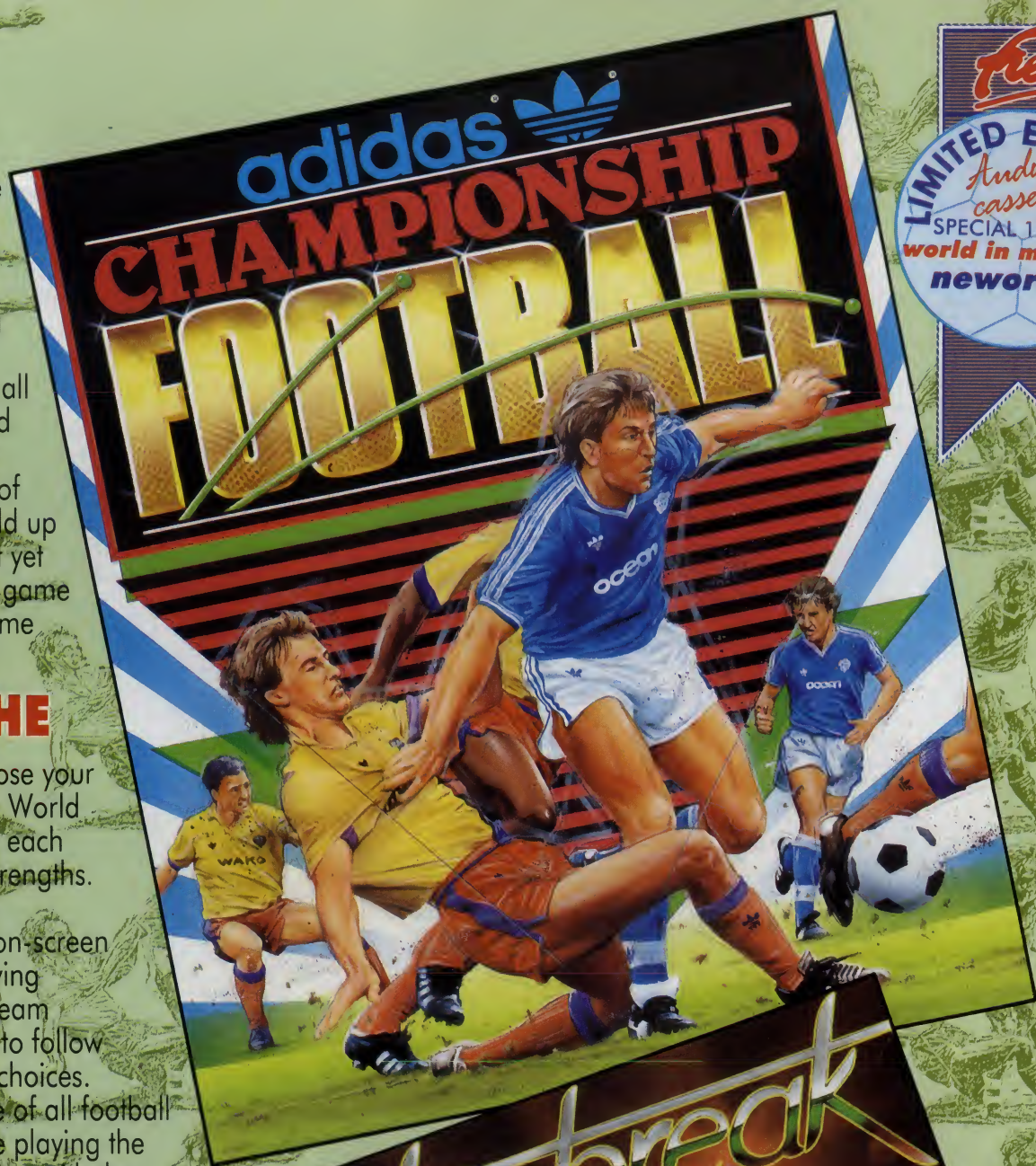

*Free*  
LIMITED EDITION  
*Audio cassette*  
SPECIAL 12" MIX  
world in motion...  
neworder



WIN  
£500  
adidas  
SPORTSWEAR  
FREE  
STYLISH  
DETAILS 95-97



6 Central Street · Manchester  
M2 5NS · Tel: 061 832 6633  
Fax: 061 834 0650

# 16 BIT CENTRE

ALL PRICES INCLUDE VAT AND COURIER SERVICE

CALLERS AND MAIL ORDER WELCOME

OPEN MONDAY to SATURDAY 9am-6pm

**PHILIPS 8833  
STEREO MONITOR**  
Including Lead for Amiga  
**ONLY £239.00**

**STAR LC-10  
COLOUR PRINTER**  
Including Free Printer Lead  
**ONLY £199.00**

**STAR LC-10  
MONO PRINTER**  
Including Free Printer Lead  
**ONLY £159.00**

**NAKSHA**  
Upgrade Mouse for all  
Amigas. Includes  
Mouse Mat plus holder.  
**ONLY £28.50**

## A500 XMAS PACK

### STILL AVAILABLE

Includes: A500, Mouse, Modulator, Leads, Workbench, Basic, Tutorial, Joystick, Mouse Mat, Disk Bank, 10 Blank Disks, Amiga Dust Cover, F-29 Retaliator, Rainbow Islands, Escape Robot Monsters, Deluxe Paint II, Insanity Flight, Star Wars, Empire Strikes Back, Return of the Jedi, Bubble Ghost, Warlocks Quest, Chamonix Challenge, Passengers on the Wind 1 & 2, Zynaps.

**ONLY £399.00**

The games may change depending on availability.

## HARDWARE

COMMODORE A590, 20Mb Hard Disk, Unpopulated .....	£369.00
COMMODORE A590, 20Mb Hard Disk, Populated to 2Meg .....	£489.00
COMMODORE official A501 Ram expansion .....	£89.00
COMMODORE 1084 P monitor .....	£239.00
PHILIPS AV7300 TV TUNER .....	£69.00
PHILIPS 8833 Stereo Monitor inc Lead for Amiga .....	£239.00
TARGET Sound Sampler plus software .....	£29.00
SOPHUS S5 Professional Stereo Sound Sampler .....	£99.00
NAKSHA Mouse .....	£28.50
TARGET Midi Interface, In, Through, 3 x out, LED's signal Data Transfer .....	£29.00

## PRINTERS

STAR LC-10 MONO PRINTER .....	£159.00
STAR LC-10 COLOUR PRINTER .....	£199.00
CITIZEN SWIFT 24, 24 Pin Mono Printer, (Upgradeable to Colour) .....	£299.00
CITIZEN SWIFT 24, 24 Pin Colour Printer .....	£329.00
CITIZEN 120D .....	£139.00
CITIZEN SWIFT 9, 9 Pin Colour Printer .....	£259.00
SWIFT 24 Colour upgrade .....	£35.00
Epson LQ400 24 Pin Printer .....	£249.00

All printers supplied with 1.8M cable.

## SOFTWARE AND DISKS

ARENA ACCOUNTS .....	£119.00
3M DS/DD Disks, Box of Ten inc. Labels .....	£12.95
COMICSETTER .....	£39.00
SUPERBASE PERSONEL .....	£39.00
RAINBOW ISLAND .....	£14.00
FANTAVISION .....	£29.00
XCOPY V2.1, Copier + Text Editor (H/W V6.4 £29.00) .....	£19.95
PEN PAL .....	£110.00
AEGIS Sonix V2.0 .....	£35.00
ESCAPE FROM THE PLANET OF THE ROBOT MONSTER .....	£9.99
VIDEO STUDIO .....	£89.00

## NEW LOW COST DISK DRIVE

- SLIM DESIGN METAL CASE     880K FORMAT CAPACITY  
 ON/OFF SWITCH                 THROUGH PORT  
 HIGH QUALITY CITIZEN        MECHANISM

**ONLY £74.95**

## TARGET RAM EXPANSION

512K RAM EXPANSION FOR A500  
USES 100NS Chips for true fast RAM

**ONLY £59.00 (£49.00 Without Clock)**

## AMIGA PACKS

FLIGHT OF FANTASY, includes F29 Retaliator, Rainbow Island, Escape/Planet/Robot Monster, D Paint II .....	£365.00
AMIGA STARTER PACK Includes A500, Modulator, Mouse, Workbench, Basic, 5 Commercial Games + Joystick .....	£369.00
AMIGA 1 MEG PACK Includes A500, Commodore A501 Ram Expansion + Deluxe Paint III .....	£499.00
1 MEG SPECIAL, Amiga A500, with Fitted 512K Target Ram .....	£415.00
AMIGA B2000, 1084 MONITOR, PC XT Bridgeboard, 30Mb HARD DRIVE, Rom 1.3, Workbench 1.3 .....	£1399.00
AMIGA B2000, 1084 MONITOR, PC AT Bridgeboard, 30Mb HARD DRIVE, Rom 1.3, Workbench 1.3 .....	£1995.00
Amiga B2000, 1084 Monitor XT Bridgeboard, 40Mb, 19 MS Autoboot, Hard Disk, 3Mb of RAM .....	£1899.00

**ALL AMIGA A500's SUPPLIED WITH MOUSE, MODULATOR, MANUALS, LEADS, WORKBENCH, BASIC + TUTORIAL**

**HOW TO ORDER:**  
Either call our number below with your credit card details, or send a cheque/PO or credit card number and expiry date to our address. Make cheques payable to  
**THE 16 BIT CENTRE**  
Prices subject to change without notification.

# 16 BIT CENTRE

Unit 17,  
Lancashire Fittings Science Village  
Claro Road, Harrogate HG1 4AF

**Tel (0423) 531822/526322**

**Warranty on hardware including Commodore.**  
Please note that all products that require repair under warranty will be repaired within 5 working days if customers have taken out our extended warranty plan. Please phone for further details



# Ladbroke Computing International

ST World  
'Best Dealer' 1989



## Please Read: Terms Of Sale

All prices are correct at copy date, 18/06/90 and are subject to change without prior notice. All prices are accurate while stocks last. Phone for up to date prices. All prices include VAT. Delivery, in Mainland UK, is free on orders over £100 (phone for next day courier delivery).

## Phone us, We will try to match any price.

### Amiga Drives

Vortex 40Mb	£ 499.99
Supra 30 Mb	£ 674.99
Third Coast 65 Mb	£ 659.99
Cumana 1 Mb floppy, disable switch and through port (New slimline low noise model CAX 354)	£ 64.99
Cumana 1Mb 5 1/4" floppy drive, disable switch and through port, 40/80 track switch(CAX 1000S).	£ 129.99
Disk drive dustcover	£ 2.99

### Peripherals

A2000 PC-XT bridgeboard	£ 558.99
A2000 PC-AT bridgeboard	£ 792.99
Master sound sampler	£ 34.99
2Mb RAM expansion for A500	£ 539.99
Midi Master 1 in, 1 thru, 3 out	£ 32.99
AMAX Mac emulator	£ 124.99
128K Mac ROM's	£ phone
AMAS Sound sampler	£ 91.99
Digi-view gold V3.0	£ 137.99
Semi-Professional quality genlock	£ 275.99
Studio quality genlock	£ 793.99

### Monitors & Tv's

Philips 8833 colour, stereo monitor. A best-selling monitor which exploits the excellent sound quality of the Amiga. £249.99

Philips 8802 colour, mono monitor £239.99

Philips 15" FST Remote, Scart input, Teletext Tv with 60 tuner presets. £ 269.99

Commodore 1084 phone

An Amiga to scart cable is included with monitors & Tv monitors.

### A4 Flat Bed Scanner

This high quality 200dpi flat bed scanner is also a thermal printer and photocopier. It can scan high resolution images in up to 16 grey scales. Software and cable are provided for the ST or Amiga with 1Mb of memory or more. The software allows capture, printing, load and save of images in a number of formats (ST software includes image editor). Ideal for DTP, this is probably the most cost effective piece of office equipment you could own.

**£449.99**

### Quality 3.5" Disks

Quantity	Unbranded		Sony
	Loose	Boxed	Boxed
10	£6.99	£7.99	£9.99
100	£64.99	£74.99	£89.99

All our disks are top quality Sony, Maxcell or Kao products. All disks carry an unconditional lifetime guarantee. Please add 60p p&p for each pack of ten disks.

### Price Beaters

Joysticks from	£4.99
Trak ball converted to work as mouse on Amiga	£19.99
Mouse mats from	£5.99
A500 Dustcover	£3.99
Printer Dustcover	£7.99
Monitor Dustcover	£4.99
3.5" disk care kit	£5.99
80/100 disk box	£9.99

### Memory Upgrade Boards

\* Available with or without calendar/clock. \* Plugs easily into A500 slot so no soldering. \* Switch provided to switch RAM in/out. \* Battery backed calendar/clock, retains time/date on switch off. \* Amazing low price.

512K RAM Extension board	£24.99
512K RAM Extension board + clock	£34.99
512K RAM Extension board + chips	£64.99
512K RAM Extension board + clock + chips	£74.99

Our trained technicians can repair all hardware, including Amigas, in minimum time at competitive rates.

### Amiga Packs

Pack1=Batman pack, mouse, modulator	£369.99
Pack2=Batman + pack, mouse mat, joystick, Tenstar pack	£399.99
Pack3=Flight of Fantasy Pack	£379.99
Pack 4=Pack1 + 512K RAM extension	£429.99
Pack 5=Pack 1 + CM8833 Colour Monitor	£609.99
Pack 6 =Pack 4 + CM8833 Colour Monitor	£674.99
Amiga 2000 Pack includes A2000, PC-XT bridgeboard, 5 1/4" drive, 20Mb Amiga/MS-DOS hard drive, 1084S colour monitor	£1585

Phone for other combinations of hardware / software.

### Quality Low Price and Professional Series Printers

Star LC-10 Best-Selling mono 9 pin	£ 169.99 *	Star FR-10 mono 9 pin, 300 cps draft elite, 16 NLQ fonts	£ 399.99 *
Star LC-10 2 faster version of LC-10	£ 189.99 *	Star FR-15 15" carriage version of above	£ 499.99 *
Star LC-10 Colour 9 pin, 7 colour printer	£ 209.99 *	Star XB-24/10 24 pin SLQ, LQ, 240cps draft elite	£ 499.99 *
Star LC-24/10 24 pin mono excellent quality	£ 239.99 *	Star XB-24/15 15" carriage version of above	£ 649.99 *
Citizen Swift 192/64cps 24 pin mono.	£ 319.99 *	7 colour upgrade kit for XB-24/10 and XB-24/15	£ 39.99
Citizen 120D 9 pin mono. Lowest price	£ 139.99 *	Star Laser Printer 8, 1 Mb memory, 8 resident fonts, 8 pages per min, 300 Dpi	£ 1599.99 *
Atari SLM804 Laser Printer, 90 days on site warranty	£ 1099.99		

\* Includes Amiga Centronics cable. All Star printers include 12 months on site warranty.

#### How to Pay

You can give credit card details over the phone or send a cheque or postal orders made payable to Ladbroke Computing International.



**(0772)203166 Fax 561071**



Shop & Mail order premises: 33 Ormskirk Road, Preston, Lancashire, PR1 2QP Open Monday to Saturday 9:00am to 5:00pm. Dealer enquiries welcome. Ladbroke Computing International is a trading name of Walton Marketing Limited.

To assist us in processing your order please quote this code.

**SAM4.2**

# AMIGA

**New**

## 4 Mb

## 68020

**New**

## CARD

**NOW ONLY**

## £349\*

\* Price includes 68020 + 1Mb of ram.

- Enjoy the performance of 5.5 Amigas under the lid of your computer
- Run graphics packages at lightning speed (upto 40 times faster with 68882)
- Loads Kickstart into 32-bit SUPER-FAST RAM (software selectable!)
- Our RAM price is more cost effective than any A501 compatible (runs faster too!)
- THE 20-CARD is compatible with the A500 and the A2000
- Runs programs 5-6 times faster than a standard Amiga
- THE 20-CARD comes with 1 Mb installed (remaining 3 Mb socketed)
- THE 20-CARD operates at a FULL 16 MHz (asynchronous design)
- THE 20-CARD has a socket for the 68881/68882 maths coprocessor (16 MHz)
- THE 20-CARD uses low price 256x4-100ns DRAMS (has no wait states)
- THE 20-CARD has a superior DRAM design enabling it to out perform some 20 MHz cards
- THE 20-CARD is the ONLY card to auto-synchronise with the Amiga perfectly
- THE 20-CARD fits internally into the 68000 socket and is compact in design (7.75 x 5.3 inches overall dimensions)
- AFTER A WEEKS USE YOU'LL WONDER HOW ON EARTH YOU MANAGED WITHOUT IT!

### ORDER FORM

I enclose a cheque/Postal Order for £349 (inc. VAT) payable to:-

**SOLID STATE LEISURE LIMITED**

Signature: \_\_\_\_\_ Name: \_\_\_\_\_

Address: \_\_\_\_\_

Post Code: \_\_\_\_\_

Send to: Solid State Leisure Limited, 80 Finedon Road, Irthlingborough, Northants NN9 6TZ.  
Tel: (0933) 650677 - Monday to Saturday 9.30-5.30pm

Please allow up to 28 days for delivery

# TREBLE

*Champions*

A STUNNINGLY REALISTIC FOOTBALL STRATEGY GAME



TREBLE CHAMPIONS -

*Can YOU Win the League Championship, The F.A. Cup and the League Cup?*

*An Amazing range of Realistic Features and Superb Gameplay combine to create all the Tension, Drama and Excitement of Football Management as you compete for Soccer Glory and -*  
**THE TREBLE.**

### AN OUTSTANDING RANGE OF FEATURES

- 4 Divisions of 20 Teams
- Non-League Division of 20 Teams
- Full Home and Away League Programme - 38 Matches
- Results of ALL games for ALL 5 Divisions
- League tables for ALL 5 Divisions
- F.A. Cup including Non-League Teams
- League Cup (1st, 2nd Round and Semi-Final over 2 Legs)
- Promotions and Relegations
- Only 1 Team Promoted from Non-League Division
- Squad of 20 Players and Reserves
- Squad of 15 Players for ALL Other Teams
- Details of over 1500 Players
- Transfer Market - Offer for any Player in any Division
- Transfer Deadline
- Long and Short Term Injuries
- Time management System - limited time for Club management each week
- 2 In-Match Substitutes
- Opposition use Substitutes
- Fitness Training - Keep your Squad at maximum fitness
- Coaching - Improve the Ability of your younger Players and Reserves
- Midweek Matches
- Cup Replays
- Penalty Shoot-Outs
- Player Retirements
- Change Player/Team Names
- Season ticket, Wages, Bank Loans, Interest, Attendance
- SAVE GAME
- 3 Skill Levels
- Start in any Division
- PLUS MUCH MUCH MORE

### SPECTRUM SCREEN SHOTS

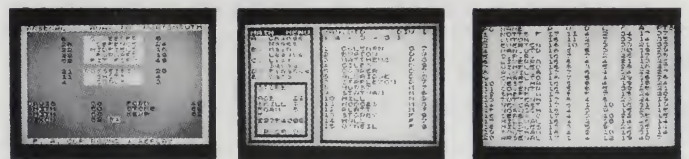

ALL VERSIONS INCLUDE COMPLETE INSTRUCTIONS

SPECTRUM 48/128K: Tape £9.95. Disk £13.95. COMMODORE 64/128K: Tape £9.95. AMSTRAD CPC 464: Tape £9.95. CPC664/6128 Disk £13.95.  
ATARI ST £19.99 OUT NOW ★ AMIGA £19.99 OUT NOW ★

AVAILABLE NOW FROM RETAIL OUTLETS AND BY MAIL ORDER FROM:

CHALLENGE SOFTWARE, 37 Westmoor Road, Enfield, Middlesex, EN3 7LE.

Please make your Cheque or Postal Order payable to Challenge Software and state which machine. Orders outside U.K. add £1. Add £1.50 for Air Mail outside Europe

**081 443 1936**

**CHALLENGE**

**SOFTWARE**



**SUPER CARS**

Don't slimy car salesmen get up your nose? Ooh they think they're sooo clever! *Super Cars* has a slimy salesman, and he's particularly obnoxious. To deal with him you have to say the right thing at the right time. Stap me vitals! There's a coincidence! We just happen to have a list of all the responses you need to use! What a piece of luck!

Are you a scruffy piece of string?  
Are you trying to take me for a sucker?  
Are you trying to rip me off?

Can't we compromise?  
Come on, we're both businessmen.  
Could you reduce the price please?

Does it come with a guarantee?  
Does it have a petrol tank?  
Does it run on nuclear power?  
Does it run on unleaded?  
Does the imredifluidator work?  
Don't be daft, frog face.  
Don't make me laugh. \*  
Don't push me.

Go ahead punk, make my day.

Has the car got rust?  
Have you got the time? \*  
Heads or tails? \*  
Hey, I'm paying cash you know.  
Hmmm...I did want some extras also.  
How about a round of golf?  
How's the sub-frame?

I can't really find that much.  
I could MURDER a curry.  
I think it's started to rain.  
I need a second mortgage.  
I ought to knock your lights out.  
I used to know your mother.  
I'm a lumberjack.  
Is it fitted with CAT?  
Is that a wig you're wearing?  
Is the car insured?  
I've got a cat called Garfield.  
I've got a garage.

Make me a better deal than that.

Not for a rustbucket like that.

That's a disgusting suit.  
That's a fair profit margin.  
This parrot is dead.

You got moths in your wallet?  
You know you ain't half mean.  
You're asking for a bunch of fives.

Ullo John, got a new motor?

What is the airspeed of a swallow?  
Won't you take less?

Those responses that have an asterisk next to them are a bit iffy, and only work sometimes. If you do use them, cross your fingers and hope!

Adam Powell,  
Crowborough, East Sussex

**STUNT CAR RACER**

Here are some tips on coping with various tracks for all you demon drivers out there!

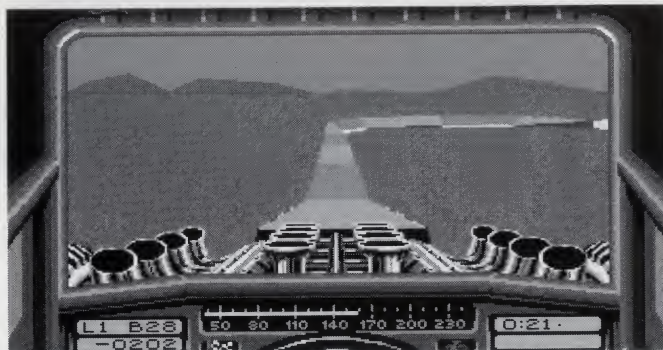

**LITTLE RAMP**

Take the first corner at full belt and tackle the ramp at 150 mph.

**HUMPBAC**

Accelerate around to the hump, so that you reach 200 mph by the time you are half way up. At this speed you should have a fair jump and landing.

On the other ramps, keep either below 130 mph or over 180 mph. Anything between these speeds will result in heft damage. The rest of the track should be taken at a speed of something around 170 mph.

**BIG RAMP**

Take the first two small ramps at 170 mph, then get up to 210 mph for the main ramp. The rest of the course should be a doddle.

**STEPPING STONES**

Head down the starting straight at 110 mph and take the second gap at 100 mph. When you get to the steps, push up to 140 mph and nudge the speed up if it falls below 110 mph.

**HIGH JUMP**

Get up to 210 mph from the start

to clear the jump and keep under 200 mph for the small jump. You can tackle the slanted road in two ways - either keep at the top and keep the speed up, or give the car a nudge to the right every now and then. If you slip off, push right and push forward and right instantly.

**ROLLERCOASTER**

Keep under 110 mph on the first hill, and you should take the bumps fairly easily. Remember - don't push too hard!

**SKI JUMP**

Keep below 100 mph up the first

hill and on the second keep to around 140 mph, slowing down after the jump. For the big jump, get to 220 mph, but if you can't manage it just crawl around and you'll live.

**DRAWBRIDGE**

At the drawbridge, put the pedal to the floor when the bridge has gone down about halfway.

Tackle all the hills to the next ramp at 140 mph, then on the bumpy section head down the middle of the track at 170 mph. Lastly, get up to top speed for the down hill jump.

**GENERAL HINTS**

If you get stuck in a hole, drive slowly to the wall and accelerate with boost. You should hit the track or drive off the edge, minimising damage.

At the beginning of a race, accelerate and then pull left to block off the other driver - you may even manage to run him off the track completely.

David Norfolk,  
Watford, Hertfordshire

**CONQUEROR**

Imagine the headlines... **MEGA-WEAPON PACKING TANKS ARE DESTROYED BY MERE DUMMY COMPUTER ENEMIES. A bit on the embarrassing side, what? Well, to stop this from happening in Rainbow Arts' superb tank-battle simulator have a shuftie at these official hints from the developers themselves (nothing but the best for Amiga Format readers, doncha know).**

German tanks have a worse hill climbing ability than both American and Russian tanks. This point determines strategies for both divisions - if you're playing as the Germans, a good tactic is to wait at the top of hills and rush down at the enemy when they approach, whereas if you take control of the allies, then it's a good idea to escape by heading up the steepest hill, so as to slow down any tanks that are in pursuit.

The program actually works out the angle of incidence of any shot, and uses the data to calculate the most effective use of armour. Therefore an oblique shot on a tank will have more armour to penetrate than a 'square on' blast. So if you are under attack, try to make sure that the enemy have to fire angled shots, but if you are attacking, then try to get a good, straight (that is 90 degrees) shot to do the most damage.

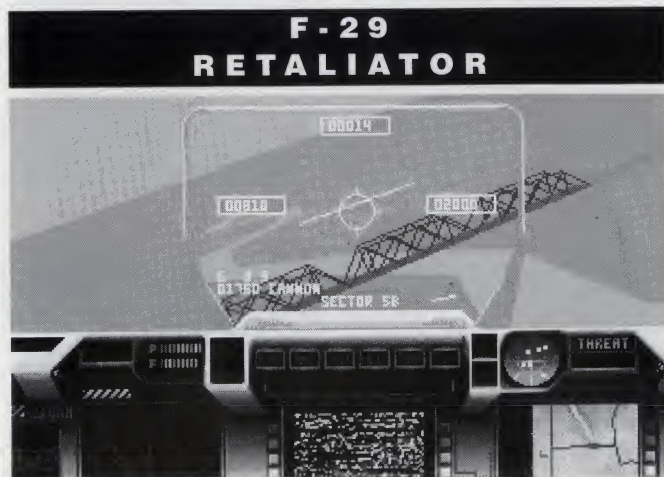

There's nothing worse than finding yourself stranded in mid-mission with no weapons! To avoid this, simply enter your name on the enrolment screen as CIARAN, then load up your pilot's log.

The name should now read OCEAN OK. Now you can fly any mission with the benefit of infinite missiles and cannons.

Bryn, Winston,  
Bardsley, Oldham

Front armour is the best defence on all tanks, so always try to face the enemy straight on so as to present the toughest face. For this reason, you should also try to attack enemy tanks' flank or rear where they are less protected.

One of the most sensible tactics to use (the computer player employs this) is to form the heavy tanks into groups and leave the light tanks to reconnoitre. This means that the lighter, faster tanks can act as your 'eyes', giving advance warning of enemy manoeuvres - they can also run away quickly! The tactic they use when under the auto-driver, is to run away from anything they can't shoot, reporting the sightings to your force. You can then move the heavy boys in tackle the situation.

When using map firing, always remember that any shells fired will take about 30 seconds to hit the ground, so try to judge where the enemy tanks will be when the missiles strike and aim your guns there. Be warned, however, that computer-controlled tanks don't look for map fire, so keep clear of the area until all the shells have landed.

Don't go for a whole bunch of heavy guns, instead try to build a balanced tank-force. Light tanks are useful for reconnaissance and also as an emergency reserve, whereas heavy tanks are good for straight head-to-head battles. Medium tanks combine the advantages of both light and heavy vehicles, but lack the speed and firepower of the others.

Don't forget to use your drone tanks! Direct one to hold an enemy tank's attention while driving your

tank to their rear from where you can unleash a powerful attack. Watch out when doing this though, as the computer tank has two objectives - to both defend itself and attack any player tanks. Thus it will turn it's strongest armour towards the most powerful gun and take out the lightest enemy tanks.

**THE TANKS**

Different tanks are useful for different things, and experienced players will be able to utilise the individual strengths of each. Here are some notes on the strengths of some different tanks:

- CHAFFEE - very fast and cheap.
- M36 GMC - Also very fast and has a good gun, but does suffer from fairly weak armour.
- SHERMAN FIREFLY - Good gun, medium speed capacity and quite adequate armour.
- PERSHING - Has the same gun as the M36 with medium speed, but does have the advantage of good armour.

- PANZER III - Very cheap, but not particularly good at any one thing.
- PANTHER - Excellent front armour, a good gun and average mobility, but the side and rear armour are both on the weak side.

- TIGER 1 - Excellent all-round armour and good gun.
- KING TIGER - Best armour and gun of any tank, but travels slowly.
- T34/76 - Good all-round armour (as with the other Russian tanks), good gun but has average speed.
- KV1S - Better armour than the T34/76, but has the same gun.
- KV85 - Is blessed with a better gun than the KV1S has.
- JSII - Excellent armour and gun and has good mobility.

*Thanks very much to those friendly folks at Rainbow Arts for these helpful bits of advice.*



**WINNERS!!**

This month, prizes go out to Gandalf and his mate Waz for their *Champions of Krynn* stuff, and Robert Baker for his mega-useful *Tower of Babel* instructions (it made sure I could stop playing enough to get some sleep anyway!)

Being techno whizzes here at *Amiga Format*, we can stick IFF pictures straight from the Amiga into our Macs. So if anyone out there want's to send in maps drawn on *DeluxePaint*, then they may well find their works of art winning some dosh! Send any maps and tips to *GAMEBUSTERS*, *Amiga Format*, 30 Monmouth Street, Bath BA1 2AP. Oh and PLEASE include a phone number wherever possible - we may need to get in touch with you!

**NINJA SPIRIT**

Wails of frustration and keyboard bashing brought about this major cheat discovery. After losing badly, these poor readers tried to smash hell out of their Amiga, and happened upon this helpful item. Press F9 to pause and then press

all the lettered keys in one go. The game will now restart without you having to press F10, but with the added bonuses of invincibility and infinite time. Can't be bad...unless you've got small hands and can't reach all the keys!

**R and T Parkhouse,  
Basingstoke, Hampshire**



**APB**

Bored of pounding the same beat over and over again? Well if you push the firebutton and push forward on the joystick while the music is playing, you can select to

start playing on any of the 16 levels. Now hit them streets, Officer Bob, and the best of luck ("mmmr-rnnuur... Thank you very much well done").

**Matthew Gare, St Ouen, Jersey**

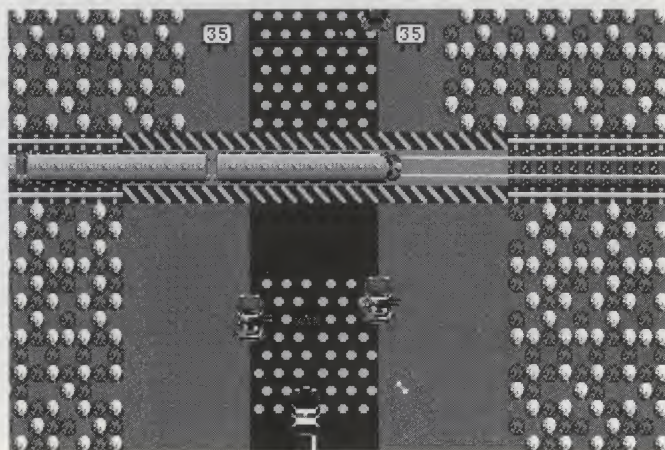



## ALTERNATIVE IMAGE

**HAVE YOUR OWN AMIGA GRAPHICS  
OR ANIMATIONS OUTPUTTED ONTO  
35MM SLIDE FILM OR VIDEOTAPE**

### BUREAU SERVICE

Have your own Amiga graphics outputted onto 35mm slide

All resolutions except overscan and halfbitrate - send for disk with safe areas and examples.

Prices inc. VAT & 1st class  
postage in UK.  
(Glass mounts 30p  
extra per slide)

UNMOUNTED PRICE	
1	£5.00
2 - 10	£4.00
11 - 20	£3.00
20+	£2.00

Please ring  
to  
Discuss  
Requirements

### ANIMATIONS DIRECT ONTO VIDEOTAPE Also IFF to BVU/SP VIDEOTAPE

Have your animations outputted, via broadcast quality equipment, onto most formats of videotape.

We can run your animation files directly onto tape.

MINIMUM CHARGE - £10 (INCLUDES VAT, POSTAGE, VHS TAPE ONLY)

For the professional approach we can render IFF files frame-by-frame onto tape for true  
25 frames per second animation, using specially designed Hardware and Software.

50p PER FRAME (+ VAT, POSTAGE, TAPE)

PLEASE RING TO DISCUSS YOUR REQUIREMENTS MANY EXTRAS ON REQUEST

### MONEY WITH ORDER

Allow 1 week for processing and delivery  
We accept cheques/postal orders made payable to:

ALTERNATIVE IMAGE PRODUCTIONS  
6 LOTHAR ROAD, AYLESTONE  
LEICESTER LE2 7QB  
(0533) 440041  
FAX (0533) 440650

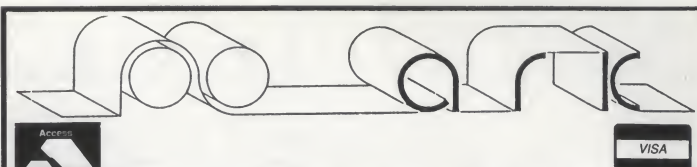

### STOCK CLEARANCE

(Few only)  
Amiga DOS Toolbox (new).....29.90  
BBS PC Bulletin Board.....79.81  
C Light Ray Tracing (S/H).....29.90  
Deluxe Paint II (of bundle).....19.78  
Deluxe Paint III (split box).....49.91  
Fantavision (from bundle).....24.84  
Lights, Camera, Action (new).....39.79  
Modula 2 Compiler (new).....39.82  
Newsletter Fonts (new).....19.78  
Panread Accounts (new).....29.90  
Project O (second hand).....29.90  
Spanish Tutor (new).....24.84  
Starter Kit (new).....49.91  
Studio Magic (new).....39.79  
The Works Platinum (new).....99.82  
World Atlas (s/hand).....34.96

### ACCOUNTS

Arena Integrated 1MB.....119.83  
Cashbook Combination.....59.80  
Desk Top Budget.....34.96  
Home Accounts.....23.92  
Personal Tax Planner.....34.96  
Personal Accounts Plus.....29.90  
Small Business Xtra 1MB.....89.93  
System 3 Integrated.....44.85

### BOOKS

Please Call

### COMMUNICATIONS

A Talk 3.....69.92  
K Comm 2.....24.84

### COMPUTER AIDED DESIGN

Design 3D 1MB.....57.96  
Professional Draw 1MB.....99.82  
X Cad Designer 1MB.....79.81

### DATABASE MANAGERS

Mailshot Plus.....37.95  
Microfiche Filer.....49.91  
Prodata.....57.96  
Superbase Professional 1MB164.91  
Superbase Personal.....39.79  
Superbase Personal 2 1MB.....62.79  
Who What When Where.....29.90

### DESKTOP PUBLISHERS

Pagesetter 2 1MB.....74.98  
Pagestream 1MB.....119.83  
Professional Page 1.5MB.....179.86

### EDUCATION

GCSE Tutors.....24.84  
My Paint.....34.96

### EDITORS

CygnusEd Professional 2.....64.86

### GRAPHICS

Animagic Editor 1MB.....54.97  
Comic Setter 1MB.....39.79  
Deluxe Paint 3 1MB.....57.96  
Deluxe Print II.....39.79  
Deluxe Video 3 1MB.....69.92  
Digi Paint 3.....49.91  
Elan Performer.....44.85  
Impact Presentations.....49.91  
Movie Setter.....51.98  
Pixmate.....38.87  
Sculpt 3D XL 1MB.....99.82  
Sculpt 4D Professional 1MB.....329.82  
Sculpt Animate 4D Junior.....84.87  
Text Scroller.....29.90  
Turbo Silver.....99.82  
Zoetrope 1MB.....79.81

### HARDWARE

1.3 A500 Kickstart ROM.....29.90  
1MB MiniMax A500 RAM.....199.87  
3.5" NEC Drive Switch/Thu.....68.77  
512K A500 RAM Clock/Switch/64.86  
A Max Mac Emulator No ROMs109.94  
A4 Flat Bed Scanner.....449.88  
A590 20MB Hard Disk Drive.....379.96  
A.M.A.S. Sound Sampler.....77.74  
Digi View Gold 4.....119.83  
MIDI Master Interface.....34.96  
Vidi Amiga PAL Digitiser.....99.82

### PACKAGES

Appetizer.....29.90  
Graphics Starter Kit.....54.97  
Home Office Kit.....99.82  
Publishers Choice.....68.77

### PROGRAMMING

ArgASM Assembler System.....49.91  
Aztec C Professional.....109.94  
Benchmark Modula 2.....139.84  
Devpac 2 Assembler System.....42.78  
GFA Basic Compiler.....28.98  
GFA Basic Interpreter.....39.79

### HiSoft Basic Compiler.....57.96

Lattice C 5.....169.97

### SOUND

Deluxe Music.....52.90  
Instant Music.....22.77  
Music X.....169.97  
Sonic.....39.79  
Studio Magic.....49.91

### SPREADSHEETS

Advantage.....79.81  
DGCalc.....31.97  
Superplan 1MB.....67.85

### UTILITIES

Ami Alignment Kit.....34.96  
Amikit For Beginners.....29.90  
ARexx Macro Interpreter.....34.96  
Award Maker Plus.....34.96  
B.A.D. Disk Optimiser.....31.97

BBC Emulator.....34.96

CrossDOS File Transfer.....29.90

Disk Master Housekeeper.....39.79

DOS 2 DOS File Transfer.....29.90

D.U.D.E. Housekeeper.....34.96

Enhancer 1.3 S/W Upgrade.....14.72

MAC 2 DOS File Transfer.....69.92

Masterpiece Fonts (110!).....129.95

Mavis Beacon Typing.....27.83

Norgen Genealogy.....59.80

Project O Backup/Editor.....31.97

Superback 2 H/D Backup.....39.79

Virus Infection Protection.....34.96

X Copy Backup/Editor.....17.94

Your Family Tree Genealogy.....34.96

### WORDPROCESSORS

Kindwords 2.....35.88

Microtext.....17.94

PenPal.....99.82

Protex.....64.86

Scribble (Platinum).....41.86

Transcript.....32.89

Wordperfect.....164.91

**Applied Research Kernel**  
**Richard Howe & Angela Hammett**  
Corve Farmhouse, Chale Green, Ventnor, PO38 2LA, U.K.  
POST UK Zero. Software to Europe £4/Item. World £10/Item  
CHEQUES London Sterling payable to A.R.K. please  
EXPORT & BFPO Remove U.K. V.A.T. (-price/1.15)  
PHONE Monday to Saturday 10.00am to 6.30pm  
V.A.T. Prices include U.K. V.A.T. at 15%  
DESPATCH Usually within 48 hours  
PRICES Are subject to change

# AMIGA FLIGHT OF 500 FANTASY

**Pack includes .....**

Amiga A500, Power Pack, Modulator, Work Bench 1.3, Amiga Basic, First English Version Mouse, **F29 Retaliator, Rainbow Islands, Escape From The Planet Of The Robot Monsters, Photon Paint II, 5 Blank Discs and Mouse Mat.**

PLUS FREE Delivery - No hidden extras  
The price you see is the price you pay

**ONLY £379.99**

**FROM**

BELSHAW'S COMPUTER SHOP  
52 BALDERTONGATE, NEWARK,  
NOTTS NG24 1EQ  
TELEPHONE: (0636) 72503

**CALLERS WELCOME**

## MAKE YOUR AMIGA EARN

Yes making money with your Amiga becomes incidental when you know how. Your micro is, if only you knew it, a gold mine. The size and make is irrelevant. Make the initial effort NOW by starting your own

### HOME BASED BUSINESS

*This may be the most important move you will ever make!*

REMEMBER: You'll never get rich by digging someone else's "ditch". Anyone in the country, including YOU, can become very rich in a relatively short period of time just by doing a few basic things! It's more rewarding than playing games. The benefits are many and varied. Full or part time. For FREE details send S.A.E. to:



## HOME BASED BUSINESS

31, PILTON PLACE (AF13)  
KING AND QUEEN STREET,  
WALWORTH, LONDON SE17 1DR

## J. D. LEWIS REPAIRS & SPARES

### SPARES:

68000 MPV.....£23.00 8364 Paula.....£32.00  
8371 Fat Agnus.....£43.00 8520.....£12.50  
ROM.....£21.00 5719 Gary.....£15.00  
8362 Denise.....£22.00 Service Manual.....£22.00

### ACCESSORIES:

Parallel lead.....£6.95 Mouse mats (hard)..£3.95  
KAO bulk disks £6.50 (for 10)

A500 fixed price repair (excluding disk drive and PSU)  
£40.00

All Datel products available. (Contact for prices)

42, Harcourt Avenue, Meir, Stoke-on-Trent, ST3 5LX.

Or Telephone: 0782 323348

\* All prices subject to availability

# Evesham Micros

RETAIL SHOWROOMS

63 Bridge Street  
Evesham  
Worcs WR11 4SF  
☎ 0386-765180  
fax: 0386-49761  
Open Mon-Sat, 9.00 - 5.30

5 Gilson Road  
Cambridge CB1 2HA  
☎ 0223-323898  
fax: 0223-322883  
Open Mon-Sat, 9.30 - 6.00  
Specialist Education Centre

1762 Pershore Road  
Cottrelidge  
Birmingham B30 3BH  
☎ 021-458 4564  
fax: 021-433 3825  
Open Mon-Sat, 9.00 - 5.30

ALL PRICES INCLUDE VAT AND DELIVERY  
Same day despatch whenever possible. Express Courier delivery £5.00 extra.

MAIL ORDER DEPARTMENT

Unit 9 St Richards Rd, Evesham, Worcs WR11 6XJ



Call us now on ☎ 0386-765500

8 lines, Open Mon-Sat, 9.00-5.30. Fax: 0386-765354  
Technical support (open Mon-Fri, 9.30-5.30): 0386-40303



Send an Order with Cheque, Postal Order or ACCESS/VISA card details

Government, Education & PLC orders welcome  
All products covered by 12 Months Warranty  
All goods subject to availability, E. & O.E.

Buy with confidence from one of the longest established companies in their field, with a reputation for good service and prices. We have invested heavily in a computer system to enable our Telesales staff to provide up-to-the-minute stock information, coupled with highly efficient order processing. Our fully equipped Workshop enables us to carry out almost any repair on our premises. We feel sure that you won't be disappointed if you choose Evesham Micros.



AMIGA  
SPECIAL  
DEALS

All A500 Packages also include the following :

Karate Kid II	Jaws	Wordwright (w/processor)	Super Huey
Leatherneck	Delcon 5	Nigel Mansell's Grand Prix	Goldrunner
Battle Squadron	High Steel	Better Dead than Alien	Night Walk

Amiga 500 512K Flight of Fantasy pack includes 4 software titles and TV modulator ..... £379.00  
Amiga 500 512K Batpack includes 4 software titles and TV modulator ..... £379.00  
Amiga 500 1Mb Batpack (OR F.O.F. Pack) features our 1Mb RAM Upgrade fitted ..... £419.00  
Amiga 500 Batpack (OR F.O.F. Pack) with Drive includes our 3.5" External Drive ..... £439.00  
Amiga 500 1Mb Batpack (OR F.O.F. Pack) with Drive features our 1Mb Memory Upgrade plus 2nd 3.5" External Drive ..... £479.00

Vortex System 2000 40Mb Hard Disk ..... £499.00	A-Max Mac Emulator without Mac ROMS ..... £129.00
Vidi-Amiga including Vidi-Chrome ..... £110.00	A-Max Mac Emulator with 2 x 128K ROMS ..... £249.00
MiniGEN Genlock Adapter ..... £95.00	AMOS Game Creator ..... £37.50
Contriver Hi-Res replacement Mouse package ... £22.95	Music-X incredibly powerful music package ..... £129.00
Philips CM8833 colour monitor inc.cable ..... £259.00	Home Accounts (Digita) ..... £18.95
Omega Projects MIDI interface ..... £29.95	Amiga 500 dust cover ..... £4.95

## CBM A590 HARD DRIVE

Good quality Commodore 20Mb Hard Disk, including its own PSU and built-in cooling fan. Features sockets for up to 2Mb of RAM expansion (see below). 80ms Access time, with up to 2.4Mb/sec transfer rate. Autoboots when used with Kickstart 1.3.

only £379.00

A590 512K RAM Upgrade kit ..... £36.00  
A590 1Mb RAM Upgrade kit ..... £70.00  
A590 2Mb RAM Upgrade kit ..... £135.00  
RAM upgrades fitted free when bought with A590.

NEW! Genuine replacement Commodore Amiga P.S.U. .... £39.95

## A500 SOLDERLESS RAM UPGRADES

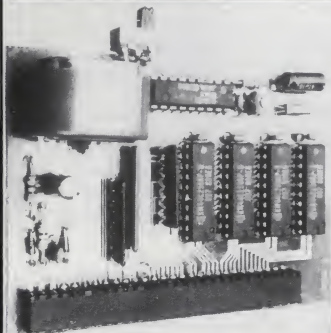

**512K  
MEMORY  
UPGRADE**  
**ONLY £43.00**  
including VAT & delivery

### 512K RAM/CLOCK EXPANSION FEATURES :

- ☆ Direct replacement for the A501 expansion
- ☆ Convenient On / Off Memory Switch
- ☆ Auto-recharging battery backed Real-time Clock
- ☆ Compact unit size : Ultra-neat design
- ☆ Only 4 low power consumption FASTRAMs

512K RAM expansion without clock only £37.00

## NEW! 1.5MB RAM BOARD

- ☆ Fully populated board increases total RAM to 2MB !
- ☆ Plugs into the trapdoor expansion (as with 512K unit)
- ☆ Auto-recharging Battery Backed Real-Time Clock
- ☆ Socketed FASTRAM ICs for accommodation up to 1.5MB

Note : when installing over 512K, an internal connection to the GARY chip is required.  
Unpopulated RAM Expansion Board with Clock ..... £39.95  
RAM Board with Clock, with 512K FASTRAM installed ..... £69.95  
RAM Board with Clock, with 1 Mb FASTRAM installed ..... £94.95  
RAM Board with Clock, with full 1.5Mb FASTRAM installed .. £119.95

## 3.5" EXTERNAL DRIVES



- Suits Amiga 500 or Amiga 1000
- Teac / Citizen drive mechanism
- On / Off switch on rear of drive
- Throughport connector
- 880K Formatted capacity
- Slimline design
- Very quiet
- Long cable for location either side of computer
- Full 12 months guarantee

Superb low price!

**£64.95**  
including VAT and delivery

5.25" External 40/80 Track Drive also available, only £99.00

## SPECIAL NEW PRODUCTS

**MIDI  
INTERFACE**  
Only £ 19.95

### GET CONNECTED!

Our new fully compatible, high quality MIDI interface connects directly with the Amiga serial port and provides IN, OUT and THRU ports for good flexibility. Features LED indicators on each port to assist ease of use and also for diagnostic purposes. Superb compact design.

**'TESSA'  
speaker system**  
Only £ 34.95

### HEAR THAT STEREO!

Your Amiga produces excellent quality hi-fi stereo sound. Enjoy high quality, stereo sound reproduction to the full with this great new twin speaker system! Incorporates a specially designed, quality 2.5 watt per channel amplifier, with volume control, to obtain the best sound.

**PHILIPS 15" FST  
TV / Monitor  
(MODEL 2530)**

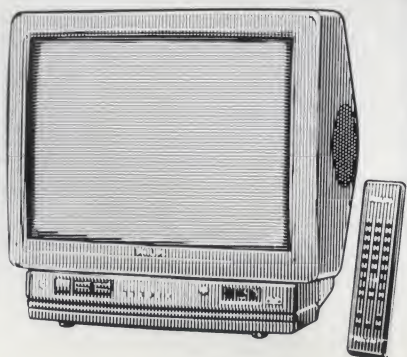

With its dedicated monitor input, this model combines the advantages of a high quality medium resolution monitor with the convenience of remote control Teletext TV - at an excellent low price!

**£269.00**  
includes VAT, delivery and computer connection lead

## PRINTERS Prices include VAT, delivery and cable

Star LC-10 top-selling 9-pin printer, includes 2 extra ribbons free ..... £159.00  
Star LC-10 7-Colour version, including 2 extra black ribbons free ..... £209.00  
Star LC-15 wide carriage version of above LC10 ..... £329.00  
Star LC24-10 multifont 24pin printer, amazing low price ..... £239.00  
Star FR-10 9pin 300/76cps with 31K buffer, 16 NLQ fonts, EE-PROM memory & 12 months on-site maintenance ..... £399.00  
Star FR-15 wide carriage version of above FR-10 ..... £499.00  
Olivetti DM100S super 9 pin 200/30cps, 1 year on-site warranty ..... £129.95  
Panasonic KXP1180 feature-packed multifont 9 pin 11" ..... £179.00  
Panasonic KXP1124 good specification multifont 24 pin 11" ..... £259.00  
Epson LX400 budget 10" 180/25 cps ..... £159.00  
Epson LQ400 (features as LQ550) 10" 24 pin, 180/30 cps ..... £229.00

**Access**

**DATAPLEX**

129 Bath Road, Slough, Berkshire SL1 3UW  
Telephone: 0753 35557

19 High Street, Swindon, Wiltshire  
Telephone: 0793 488448

All prices excluding VAT and delivery

**AMIGA HARDWARE**

Amiga Batman Pack .....£317.00  
New Amiga Flight of Fantasy .....£317.00  
New Amiga Batman Plus 5  
GamesPack Plus  
Joystick .....£345.00

**AMIGA ACCESSORIES**

A501 - 512K Ram + clock .....85.00  
TV Modulator .....15.00  
Mouse Mat .....4.00  
Amiga to Philips Lead .....10.00  
Amiga to Printer Lead .....10.00  
Quickshot II/Stick .....10.00

**DATAPLEX DRIVES**

1MB 3.5" External Drive .....68.00  
1MB 3.5" Internal Drive .....63.00  
1MB 5.25" External Floppy Drive .....95.00

**NEW AMIGA CLASS OF '90'S**

Including:  
Art & Design feature, Word Processing,  
Desk-Top Publishing, Spreadsheet,  
Music, Logo and BBC Emulation ...439.00

**PHILIPS MONITORS**

CM8833 14" RGB/CVBS mon.....199.00  
CM 8833 14" RGB/CVBS mon  
(including cables).....219.00

**PRINTERS**

Amstrad LQ3500 DI .....189.00  
Amstrad DMP4000 .....175.00  
Amstrad LQ5000 DI .....295.00

**DOT MATRIX RANGE**

Citizen 120D .....120.00  
Citizen 180E.....127.00  
New 24pin swift 24 .....255.00  
Colour upgrade for swift .....42.00

*All Citizen printers come with 2 year warranty*

Epson LX400 .....139.00  
Epson LX850 .....182.00  
Epson FX850 .....310.00  
Epson FX1060 .....410.00  
Epson LQ400 .....215.00  
Epson LQ500 .....249.00

**Epson LQ550** .....289.00  
**Epson LQ850** .....445.00  
**Epson LQ860** .....525.00  
**Epson LQ1060** .....654.00

**HEWLETT PACKARD**

Thinkjet.....265.00  
Quietjet .....343.00  
Quietjet+ .....412.00  
Deskjet .....443.00  
Deskjet + .....549.00  
Paintjet .....729.00  
Rugged Writer.....865.00

*All Hewlett Packard printers come with 12 months on site warranty*

Star LC10 mono .....135.00  
Star LC10 Colour .....168.00  
Star LC24-10 + lead & stand .....215.00  
NEC P2 + .....239.00  
NEC P6 + 80 character .....389.00  
NEC P7 136 character .....523.00  
Colour upgrade kit .....69.00  
Panasonic KXP 1081.....119.00  
Panasonic KXP1124 + lead & stand215.00  
Sheetfeeder.....89.00  
Panasonic KXP1624 (132 column) .349.00  
Panasonic KXP1180.....144.00  
Panasonic KXP1595.....319.00  
Panasonic KXP1540.....404.00

**NEW MANNESMANN TALLY LAUNCH OFFER**

MT81 (dot matrix) .....115.00  
Sheetfeeder.....62.00  
Serial I/F.....35.00

**RIBBONS**

KXP1081/1090/112 .....4.00  
DMP 2000/3000/3160 .....2.80  
DMP 4000 .....4.40  
PCW 8256/LQ3500 .....4.50  
Panasonic 3131/MP26 .....4.40  
FX800/RX/MX/FX80 .....3.15  
FX1000/FX/RX100 .....4.40  
NL 10 .....4.40  
LQ500/800/850.....4.40  
LC10 .....4.40  
NEC .....5.00

**Professional Repairs Carried Out.**

**VISA**

**LOOK! WHY PAY MORE FOR YOUR DISKS AND BOXES?**

**3 1/2" DS/DD**

**38p**

Inc. Labels

BULK BUYERS CALL FOR THE LATEST PRICES

3 1/2 DS/HD 84p

BOXES  
40 cap £4.00  
80 cap £4.30  
100 cap £4.35

SONY BULK  
3 1/2 DS/DD  
45p

5 1/4 DS/DD 23p  
5 1/4 DS/HD 50p

SAME DAY DESPATCH GUARANTEED

★ PHONE NOW FOR THIS MONTHS AMAZING OFFER ★

ADD £2.85 P&P. ADD £9 next day delivery

**AMIGAS**

World Cup Pack .....£138  
Batpack .....£358  
Ram Pack .....£43  
+ clock .....£46

Flight of Fantasy .....£359  
Class of the 90's.....£493  
External Drive .....£59

**ACCESSORIES**

Quickshot Joystick .....£5  
1000 labels .....£7.50  
Cleaning Kits .....£1.79

Black Cruiser .....£8  
1000 Tractor labels .....£8  
Mouse Mat .....£2.80

LC10 Ribbons B/W .....£3.85  
Colour .....£6.50  
Zipstick .....£11

CALL OR SEND CHEQUES TO B.C.S LTD  
349 DITCHLING ROAD, BRIGHTON BN1 6JJ

**VISA** Tel: 0273 506269 7 days. 24 hours.

**Access**

**ASHCOM**

0530 411485 0530 411485

**NEW** **NEW**

**YOU NEED 512K NOW  
HOW MUCH WILL YOU NEED  
TOMORROW?**

**THE NEW ASHCOM RAM EXPANSION IS EXPANDABLE TO 1.8Mb**

**FEATURES:**

- ★ Real Time clock/calendar with high capacity Nicad battery backup
- ★ Memory disable switch
- ★ Low power consumption
- ★ Buffered Data Bus (Essential for high capacity Ram boards)
- ★ Plugs in as A501 NO SOLDERING!!
- ★ 12 Months warranty

*All prices include VAT and delivery.  
Trade enquiries welcome. British made.  
Please make cheques payable to Ashcom*

**ONLY £89.95** for 512K version.  
Expander Board **£19.95.**  
Fully expanded to 1.8Mb only **£225**

**Rams only  
£40  
per 512K**

**ASHCOM 512K RAM EXPANSION  
WITH REAL TIME CLOCK/CALENDAR  
ONLY £48.00  
AND DISABLE SWITCH WITHOUT CLOCK  
£44.00**

**VIRUS BLOCKER** **NEW** ONLY  
£19.95  
PREVENTS THE  
WRITING OF ALL BOOT  
BLOCK VIRUSES TO DISK. SIMPLY  
PLUGS INTO EXTERNAL DISK SKT

**Only from ASHCOM, 10 The Green, Ashby-De-La-Zouch, Leicestershire, LE6 5JU  
Telephone: (0530) 411485**

# AMIGA FORMAT MAIL

THE LATEST AND GREATEST PRODUCTS AT THE BEST POSSIBLE PRICES!



1 Gain some credibility in this truly American shirt.



2 Keep your vulnerable, precious Amiga Formats safe.



3 Take to the skies!  
Top quality disks and cassettes!



7 Create your own sounds.



8 Program in 68000 NOW!



6 A brilliant Coverdisk winner



9 The escape for Dan Dare.



10 Pipe Mania!!!



11 AMOS - The creator

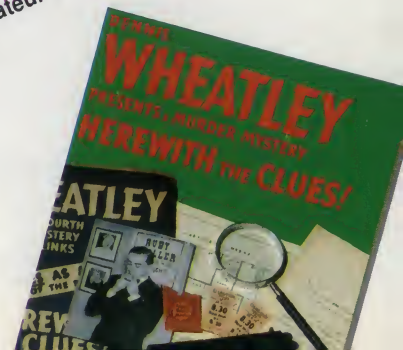

12 An amateur Detectives Treat.

**HOTLINE  
0485 74011**

HOW TO ORDER... JUST MAKE A NOTE OF THE PRODUCT NAME AND ORDER NUMBER AND FILL IN THE ORDER FORM OPPOSITE OR RING OUR HOTLINE NUMBER ON 0458 74011

PRICES INCLUDE POSTAGE, PACKING AND VAT

NO HIDDEN EXTRAS

# ORDER

Virus Killer.

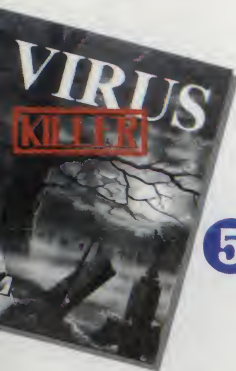

5



Get yourself round these pipes!

## BACK ISSUES



Want to complete your collection of the ultimate Amiga magazine? Back issues come complete with disks, prices include the postage and packing!

### AMIGA FORMAT

ISSUE	PRICE	ORDER NO
ISSUES 1 - 4	SOLD OUT	SORRY!
ISSUE 5	SOLD OUT	SORRY!
ISSUE 6	SOLD OUT	SORRY!
ISSUE 7	SOLD OUT	SORRY!
ISSUE 8	£3.45	AMF08
ISSUE 9	£3.45	AMF09
ISSUE 10	£3.45	AMF10
ISSUE 11	£3.45	AMF11
ISSUE 12	£3.45	AMF12



Or why not grab copies of the very rare original ST/Amiga Format? Hurry, there are limited stocks!

### ST/AMIGA FORMAT

ISSUE	PRICE	ORDER NO
ISSUE 1-10	SOLD OUT	SORRY!
ISSUE 11	£3.45	AM211
ISSUE 12	£3.45	AM212
ISSUE 13	£3.45	AM213

## SUBSCRIPTION



FOR ONLY £29.95 YOU CAN RECEIVE 12 ISSUES OF AMIGA FORMAT, DELIVERED TO YOUR DOOR. DO NOT RUN THE RISK OF THE NEWSAGENT SELLING OUT! SEE PAGE 143 FOR FURTHER DETAILS OR CALL THE HOTLINE NUMBER ON 0458 74011 ORDER CODE AM100

- ### BASEBALL SHIRT

Designed in the USA, this black and white shirt is a must for every Amiga owner (Logo on left breast and centre back)

Description	Price	Order No
Medium	£6.50	AM106
Extra Large	£6.50	AM107
- ### AMIGA BINDER

Keep your issues together in this high quality binder with the Amiga Format logo printed on the front and spine.

Description	Price	Order No
One binder	£4.95	AM108
Two binders	£9.00	AM109
- ### F29 RETALIATOR Ocean

Take to the skies in the Amiga Format Gold winner. Superb 3D graphics and lasting appeal in this combat/flight simulator.

**SAVE £7**

Description	Price	Order No
F-29 Retaliator	£17.95	AM163
- ### TDK DISKS

Ten TDK 3.5" disks with a free TDK Limited Editon SA90 cassette worth £1.99.

**FREE CASSETTE**

Description	Price	Order No
TDK Disk	£11.95	AM167
- ### VIRUS KILLER CRL

Be sure your machine, disks and programs are safe. Detect and destroy the viruses leaving your software safe.

**PROTECT YOUR FILES**

Description	Price	Order No
Virus Killer	£9.95	AM161
- ### RESOLUTION 101 Millennium

Since the passing of Resolution 101, no criminal is safe. Your objective is to drive around town and pick up these guys before they pick you off. A brilliant, super-fast, exciting game with amazing graphics.

**SAVE £6**

Description	Price	Order No
Resolution 101	£18.99	AM166
- ### QUARTET Microdeal

See Coverdisk 12, then buy this package to create your own music. "A music package with a difference" AF

**SAVE £1**

Description	Price	Order No
Quartet	£37.95	AM165
- ### DEVPAC 2 HiSoft

Program directly in 68000 assembler language. See the Coverdisk demo then buy the product at this remarkable price.

**SAVE £1**

Description	Price	Order No
Devpac	£44.95	AM157
- ### DAN DARE III Virgin

Taken from the blockbuster movie; see our fabulous game demo on Coverdisk, Issue 12. Playing the part of the hero, be sure to conquer the evil Mekon and his Treens.

**SAVE £5**

Description	Price	Order No
Dan Dare III	£14.99	AM164
- ### PIPE MANIA Ent. Int.

See the demo on Issue 9. This superb pipe game will have you hooked for ages!

**SAVE £7**

Description	Price	Order No
Pipe Mania	£12.99	AM158
- ### AMOS Mandarin

The creator. A Superb development language for creating games, educational programs-almost anything! Comes complete with Amos Sprites 600.

**SAVE £14**

Description	Price	Order No
Amos	£35.95	AM168
- ### HEREWITH THE CLUES

CRL • Loads of fun in this murder mystery game. You are the assistant commissioner of the anti-terrorist squad in pre-war London. Play the game, then enter the CRL competition to reveal the solution. "A great mystery to solve, well done, CRL" AF

**SAVE £7**

Description	Price	Order No
Herewith...	£17.95	AM162

## AMIGA FORMAT MAIL ORDER

Name	Description	Price	Order No
Address			
Postcode			
Phone number			

Method of payment (please circle) Access • Visa • Cheque • PO

TOTAL ORDER

● For overseas orders call Trevor for prices on 0458 74011

Credit Card No

Expiry date

Please make all cheques payable to Future Publishing Limited

SEND THIS FORM TO: Amiga Format, Future Publishing Ltd, Freeport, Somerton, Somerset, TA11 7BR

No stamp required if posted in the UK, Channel Islands or the Isle of Man

**MEL CROUCHER**  
-COMPUTER  
FUN LINE  
**0898 299399**

THE **NOTEST**  
GAMES  
SECRETS

New event  
**EVERY**  
WEEK!



**MEGATIP**  
GAMESLINE  
**0898 299388**

3 mins of mind blowing entertainment

Proprietor: B. Everiss, PO, Box 71, Kineton, Warwick, CV35 0XA.  
Calls charged at 25p per minute cheap rate and 38p per minute at all other times  
(Ask whoever pays phone bill)

## Matrix Hire Makes the Software World Your Oyster !

Join the Matrix and enjoy access to our huge library of the most popular titles. For Amiga, Atari ST, Commodore and Amstrad machines.

For full details send large SAE stating your machine to:-  
**Matrix Leisure Club, Dept AM/F,**  
107 The Hyde, Church Park, Ware,  
Herts, SG12 0EU  
Free Membership for quick replies.

# Seven Disk

## 3.5 inch Disks + boxes

For a stackable/lockable Banx high quality 90 capacity disk box add £9 to these prices. Banx disk box without disks £12

10 disks + 10 capacity storage box - £6  
25 disks + 50 capacity lockable box - £16  
50 disks + 50 capacity lockable box - £26  
100 disks + 100 capacity lockable box - £48  
200 disks + two 100 capacity lockable boxes - £90

### Best quality unbranded disks

3.5 inch DSDD 100% Guaranteed	5.25 inch DSDD 100% Guaranteed
10 + 50p a disk Includes labels 50 + 45p a disk and 100 + 43p a disk and 250 + 40p a disk postage 500 + 37p a disk 1000 + 35p a disk	10 + 30p a disk Includes labels 50 + 29p a disk sleeves 100 + 28p a disk and 250 + 27p a disk postage 500 + 26p a disk 1000 + 25p a disk

### Other Supplies

Disk Cleaning Kits (3.5 & 5.25) - £2.00	Roll of 1000 3.5" disk labels - £9.00
Disk Boxes - 10 capacity - £1.20	Amiga 500 dust cover £3.00
- 50 capacity - £6.50	Colour/Mono dust cover - £3.50
- 100 capacity - £7.50	Mouse/Joystick 2 metre ext. lead - £4.00

All prices are fully inclusive of VAT + postage (UK only)  
No nonsense - just fantastic value

# Super Value

Chèques/Postal Orders payable to Seven Disk. Or send Access/Visa card number expiry date and signature  
**Seven Disk. (AF). Digswell Water Lodge, Digswell Lane,**  
Welwyn Garden City, Herts. AL7 1SN  
24 hr order line - Tel: 0438 840456

# SORRY! THE WORLD IS OUR LIMIT!

## TOP QUALITY 3.5" DS/DD DISCS AT EXPORT PRICES

### ALL OUR DISCS ARE GUARANTEED

NUMBER OF DISCS ORDERED	PRICES PER DISC IN BOXES OF 10 WITH LABELS					
	GERMANY DM	U.K. P	U.S.A. \$	ITALY LIRE	SWEDEN KRONE	SPAIN PESETA
10-90	1.14	40p	0.67	840	4.15	73
100-490	1.09	38p	0.64	805	3.95	70
500+	1.05	37p	0.62	780	3.80	68
	IN BOXES OF 50 WITHOUT LABELS					
50-450	1.05	37p	0.62	780	3.80	68
500+	1.00	35p	0.59	740	3.60	64
POSTAGE (per order)	10.00	3.50	6.00	7400	36.00	640

Outside Europe please add 20% to cover shipping costs. Within U.K. please send orders to our agent -:  
Payments accepted in other currencies at current exchange rate against DM. N. Croxton, 27 Jacobean Lane, Knowle, Solihull,  
West Midlands B93 9LP.  
*Please note:* These prices do not include any local taxes (eg V.A.T.)  
*Prices subject to variation following changes in exchange rates etc.*

Tel: 056477 8608

To: GTI International Amiga Service, Zimmersmuhlenweg 73, 6370 Oberursel, West Germany.  
Telephone (49) 6171 73048 Fax (49) 6171 8302

Please send me \_\_\_\_\_ 3.5" DS/DD Discs in boxes of 10/50.

NAME ..... ADDRESS .....



Method of payment :

- Eurocheque enclosed.
- Cash enclosed (please use registered mail!).
- Access/Visa/Eurocard/Mastercard/Amex/Diners
- (Credit Card Number \_\_\_\_\_ Expiry \_\_\_\_\_)
- Cash-On-Delivery (Only available in Austria, Belgium, Denmark, Finland, France, Germany, Italy, Netherlands, Norway, Portugal, Spain, Sweden, Switzerland & U.K.).



# K & M COMPUTERS

## THE LEADING AMIGA MAIL ORDER SPECIALIST

688 Submarine .....19.99  
 A.D Ski Sim.....4.99  
 After The War.....15.99  
 Airborne Ranger.....19.99  
 American Dreams.....**N** 19.99  
 Adidas Ch.Football.....19.99  
 Ant Heads (1meg).....11.99  
 Aquanaut.....19.99  
 Armada.....23.99  
 Aladdin's Magic Lamp.....8.99  
 Bad Company.....19.99  
 Budokan.....19.99  
 BMX Simulator.....4.99  
 Balance Of Power 90.....19.99  
 Barbarian 2 (PSYG).....**N** 19.99  
 Beyond Dark Castle.....23.99  
 Black Tiger.....19.99  
 Boradino.....23.99

Kick Off 2 (Inc. World Cup).....19.99  
 Kingdom Of England.....19.99  
 Krypton Egg.....15.99  
 Karate Kid 2.....3.99

**AMIGA SECOND  
 DRIVE ONLY  
 £79.99**

Klax.....15.99  
 Leisure Suit Larry 3.....26.99  
 Knights/Crystallion.....23.99  
 Life And Death.....**N** 19.99  
 Licence To Kill.....15.99  
 Last Ninja 2.....**N** 19.99  
 Lords/Rising Sun.....23.99  
 Lost Patrol.....19.99  
 Manchester United.....19.99  
 Maniac Mansions.....19.99  
 Mechanicus.....8.99  
 Microprose Soccer.....19.99  
 Midwinter.....23.99  
 Matrix Marauders.....15.99  
 Nevermind.....15.99  
 Nuclear War.....**N** 19.99  
 North & South.....19.99  
 Oil Imperium.....19.99  
 Op.Thunderbolt.....19.99  
 P47 Thunderbolt.....19.99  
 Phantasie 3.....19.99  
 Pinball Magic.....19.99  
 Postman Pat.....8.99  
 Prince.....19.99  
 Pro. Tennis Tour.....19.99  
 Puffys Saga.....19.99  
 Rainbow Island.....19.99  
 Reach For The Stars.....19.99  
 Realm Of Trolls.....8.99  
 Red Lightning.....23.99  
 Renaissance.....15.99  
 Risk.....15.99  
 Robocop.....19.99  
 Rocket Ranger.....23.99  
 Safari Guns.....15.99  
 Sarcophaser.....8.99  
 Sherman M4.....19.99  
 Silent Service.....19.99  
 Sim City.....23.99  
 Skidz.....**N** 15.99  
 Space Harrier 2.....15.99  
 Starflight.....19.99  
 Streetfighter.....8.99  
 Stryx.....15.99  
 Super league Soccer.....19.99  
 Soccer.....3.99  
 Sword Of Sudan.....19.99

Their Finest Hour.....19.99  
 Tripatron.....23.99  
 Turracane.....15.99  
 Ultimate Golf.....19.99  
 Vulcan.....15.99  
 Warhead.....19.99  
 Wanted.....8.99  
 Waterloo.....19.99  
 W.Gretzky Ice Hockey.....19.99  
 Windwalker.....23.99  
 World Boxing Manager.....15.99  
 World Tour Golf.....8.99  
 X-Out.....15.99  
 Xenon 2.....19.99  
 Ikari Warriors.....8.99  
 Cyberball.....15.99  
 Fright Night.....3.99  
 Treasure Trap.....19.99  
 Pirates.....19.99  
 World Cup Soccer.....19.99  
 Hotshots.....8.99  
 Theme Park Mystery.....19.99  
 Shadow Warriors.....19.99  
 Sly Spy.....19.99  
 Screaming Wings.....8.99  
 Ultima 5.....23.99  
 Revolution 101.....19.99  
 Player Manager.....15.99  
 Manic Miner.....8.99  
 Treasure 1.Dizzy.....4.99  
 Outlaw.....4.99  
 Colorado.....19.99  
 Dan Dare 3.....15.99  
 Jumping Jackson.....15.99  
 Shadow Of The Beast.....19.99

**3.5" DISCS**  
 1 .....**.95**  
 5 .....**4.50**  
 10 .....**8.75**  
 20 .....**17.00**  
 30 .....**25.00**  
 40 .....**32.00**  
 50 .....**39.00**  
 100 .....**75.00**

**HALF MEG.  
 UPGRADES**  
**Without Clock..59.95**  
**With Clock.....65.95**  
**With D.Master..69.95**  
**Clock/D.Master79.95**  
**With Dr.Lair ....89.95**  
**Clock/Dr.Lair ...99.95**

**FUN SCHOOL 2  
 THREE AGE GROUPS  
 UNDER 6.  
 6-8 .8+  
 ONLY**  
**£14.95 EACH**

**BUSINESS SOFTWARE**  
 Protexit V4.2.....64.95  
 Prodata.....57.95  
 Publishers Choice.....79.95  
 Amas Midi Int & S.....74.95  
 Digicalc.....26.95  
 Cashbook Controller.....35.99  
 Devpac 2.....42.95  
 X-Cad Designer.....99.99  
 Pagesetter 2.....79.95  
 AMOS Games Creator.....44.99  
**COMPILATIONS**  
 Precious Metal.....19.99  
 Light Force.....19.99  
 Magnum 4.....23.99  
 Premier Coll. 2.....23.99  
 Leaderboard Coll.....19.99  
 Triad 2.....19.99  
 Story So Far.....15.99  
 Story So Far 3.....15.99

**JOYSTICKS**  
 Cheetah 125+.....7.95  
 Pro 5000.....13.95  
 Konix Speedking.....9.95  
 Speedking Auto.....11.95  
 Navigator.....13.95  
 Cruiser.....9.50  
 Cruiser Auto.....12.50  
 Jetfighter.....14.95  
 Cheetah Mach 1.....10.50  
 Data 1.....7.95  
 Mr Crystal.....15.99  
 Comp. Pro Extra.....15.95  
 Ergostik.....17.99  
 Superboard.....19.99

**ACCESSORIES**  
 Handy Scanner.....249.00  
 Contriver Mouse.....27.95  
 Naksha Mouse.....39.95  
 Power Supplies.....47.95  
 Mouse/J. Stick Switch.....14.99  
 Mono Digitiser.....27.95  
 Stereo Digitiser.....39.95  
 Mini Amp. & Speakers.....44.95  
 Seal & Type.....12.50  
 Printer Lead.....5.99  
 Joystick Ext. Lds.....5.99  
 4 Player Adaptor.....5.99  
 Scart Lead.....12.99  
 Star LC 10 Printer.....179.00  
 Dust Cover.....4.99  
 Disc Box (80-100).....9.99  
 Stackable Disc Box.....12.50  
 3.5" Drive Cleaner.....4.95  
 Ribbon Re-Fresh.....7.99  
 Ribbons From.....3.25  
 60g Cont. Paper2000.....16.50  
 80g Cont. Paper2000.....24.50  
 Vidi (Pal Version).....99.00  
 Hand Held Games From.....6.99  
 Midi Interface 2.....34.95  
 Screen Filter.....15.99  
 Mouse House.....3.99  
 Phillips CM8833 Colour  
 Stereo Monitor.....255.00  
 5.25 Ext. Drive.....129.00  
 Replacement Internal  
 Drive.....59.00  
 Address Labels 1000.....5.99  
 Mouse Mats.....4.99  
 Cleaning Kits.....9.99

**N = New Game**

**FREE MOUSE MAT  
 with all orders over  
 £50**

**FREE 3.5" Disc  
 With every £25  
 SPENT**

**ALL PRICES INCLUDE VAT  
 AND P&P ON ORDERS  
 OVER £5 ORDERS UNDER  
 £5 ADD £1 P&P**

**K & M COMPUTERS  
 140 SANDY LANE CENTRE  
 SKELMERSDALE  
 LANCASHIRE WN8 8LH**

**PHONE 0695 29046  
 FAX 0695 50673**



**24 HOURS**





**Sing a Rainbow**

I read your article about *Rainbow Islands* (June 1990) in your Gamebusters column. Under The Crucial Codes you gave the code SJBLRJSR. We noticed you said "we don't know what it does". It's easy: it doubles the points of the caterpillars! Thanks for the clues!

**Chris Ball**  
Hove East Sussex

**Aled Jones?**

C'mon, who do you think you are kidding! I am of course referring to your 'music for the masses' feature in which you reckoned to print a piccy of Dan Lennard (Issue 11) but in fact printed a piccy of Aled Jones - you know, the little Welsh prat of *Snowman* fame!!

Also, surely there's some mistake in the Omnibot compo, I slipped a fiver in with the answers, so I should have won!!

**Mick Heyes**  
Nelson, Lancs

PS. Tune in next month when I shall send instructions on how to construct an A2000 using a cornflakes packet and a washing-up liquid squeeze bottle!!

**Problem Children**

I am currently working in the field of child psychiatry where it has been my privilege to treat a number of children with emotional and behavioural problems. I have noticed two things over and over again: firstly that there is a high frequency of marital disharmony and separation in the homes of these children but also they almost all possess home computers (usually C64, Amiga and Spectrum). The latter is a new phenomenon of the age and along with TVs in the bedroom and videos provide an easy replacement for parental involvement.

While the most influential cause of problems in the children is the lack of a stable home environment, the secondary effect is unsupervised and prolonged use of the new technologies. Learning theorists have shown that children pick up behaviours and attitudes from their environments via what is called observational learning and it is this which causes me concern. For example, in experiments with higher apes and children it has been shown that if they are exposed to films of aggressive behaviour they will play aggressively. It has been found that boys are more at risk than girls and frustrated boys more at risk than calm secure boys.

This simple scenario brings me to the conclusion that the vast content of computer games involving extremely violent game-play,

# Letters

Address your communications to **BOB WADE** care of **30 Monmouth Street, Bath, BA1 2AP**. If it's good enough to be printed and escape the Origami treatment it could win you a T-shirt and binder.

with the latest games showing explicit combat between humans (the sword/sorcery market, Ninja martial arts games and "Rambo" games are aimed at school children and teenagers in particular) cannot be doing anything other than brutalising the conscience of a whole generation. At worst the vulnerable population of youngsters I mentioned would be lead into further problems, at best society's tolerance of an increasingly violent culture rises. (eg Hungerford, etc).

Parents generally are computer illiterate and separated by a technology gap from their children and I would suggest some form of guidelines as to the content and style of games. Legislation re both professional and public domain software is needed: however I doubt that realistically this will happen in the near future.

I also feel from the boyish tone of some of your games reviews that people have not taken seriously that the content of your fantasy life cannot be separated from what you are as a person. Perhaps I'm too old!!

**Dr A J Bell**  
Newcastle-Upon-Tyne

*Escapism is the central theme of most games, but I think it is overstating the case to say that the sort of violence displayed in computer games is having any affect at all on children in the manner you suggest. In my experience children have an excellent grasp of the difference between games and reality.*

**My Friend's is Yellow!**

Why is my friend's drive light yellow and all the other people I know have green ones?

**Ben Bashford**  
Greenwich, London

*Maybe it's got jaundice - has it been over indulging in the demon drink lately?*

**Pipemania Cheat!**

There is something that is totally baffling me. Has anyone else noticed that on the advert for *Pipemania* (AF Issue 10, Page 51), there is an AF Gold award being displayed, when in fact the game only recieved 81% in the review in the previous issue?! Is this a spot of dishonesty on the part of Empire, I wonder?

**M Thanki**  
Chatham, Kent

*It certainly isn't down to any dishonesty on anyone's part, there was a misunderstanding between ourselves and Empire that lead to them using the logo on their advert. Pipemania didn't get a Format Gold award, but it is a very good game.*

**Half-Witty**

QUESTION: What have the following phrases got in common?

WIRED FOR SOUND  
THERE IS NO ALTERNATIVE  
VIDEOSYNCRASY  
SURREAL THING  
MINDFIELD  
FOR YOUR EYES ONLY  
SPLIT DECISION

ANSWER: They are all phrases that have been printed on the spine of *Amiga Format*. ANOTHER QUESTION: Why?

**R J Crane**  
Surrey

Why not?

**Constructive Criticism**

Cover disks: 1) All hacks should have a cancel option. So should all games. The fun of re-booting palls very rapidly.

2) Personally, I would prefer it if you used only standard boot-

blocks. Having a banner saying that the disk is virus-free proves nothing.

3) I would rather have everything iconised so that I can choose the featured game demo or whatever else is offered without having to re-boot. Your recent menu format solves this problem nicely.

4) Don't forget the CLI and MORE.

5) Let's settle for one text display program and let's make sure it fills the whole PAL screen.

6) Don't strip files which were originally included with PD material and are referenced in the .DOC files. Recent examples: ACC!.COLOR, UPDATE.DOC, FUTURE.TXT, RD.

7) Don't assume that the user will put the disk in DFO:. The .DOC icon's default tool should always be: C/MORE, not DFO:C/MORE.

8) Don't assume that the user has DHO:, as you did in #10, WIPE-OUT.

9) Include version numbers in filenames to make it easy to see whether we have to update old files.

ARTICLES: Please mention the type of protection when reviewing games and other programs. (ie dongle, codeword from manual) and whether the supplier has made it possible to copy to hard disk. Please specify whether a PAL version is offered.

ADVERTISING: Advertisers asking for a SAE would be well advised to mention the amount of postage required for responses to foreign readers.

**Frank Chambers**

Newport, Ireland

**F-29 Bugs**

I wrote a letter to your sister publication *New Computer Express* outlining the failings of the recently-released game *F-29 Retaliator*. This letter was published in the 12

May issue, and the comment from the editor was that he had consulted with the *Amiga Format* staff who said that "most of F-29's bugs are just minor screen glitches".

Ah, so you noticed the flickering on the artificial horizon. Yes, that is a minor screen glitch. How about the erratic file handler that loses pilots, or occasionally promotes or demotes them at random? Or what about the fact that if you land without completing a mission you can't exit the plane except by ejecting (while on the runway!)? Screen glitch? How about the fact that the radar won't pick up SAM sites? Makes approaching enemy defences doubly difficult, but perhaps it's a minor screen glitch. What about the fact that some of the control keys have no effect? Minor, of course.

Then there's the fact that the forward radar doesn't work at all, making it impossible to identify targets unless they are so close you can see them by eye. Or the equally disastrous problem that the air-to-ground targetting system is completely non-functional, leading to the ludicrous situation that the only way to hit anything with a cruise missile (range 300km) is to line it up by sight at point-blank range! Yes, these are all minor screen glitches, aren't they?

Well, if you think that, you have no business reviewing software. I see that in the latest *Amiga Format* you have actually given this bug-ridden program a Gold rating. I hasten to point out that the above flaws are not my imagination; they were admitted in a conversation with a member of Ocean staff. Much as I enjoy reading your magazine, I can tell you this, I am never going to trust one of your reviews again.

**Roger Musson**  
Edinburgh

*To judge us on a quick comment printed by one of our sister mags is rather unfair. What we were trying to convey is the fact that although F29 was bugged, they were not the sort of bugs that crashed the machine or made the game unplayable. I agree the bugs you mention are a problem and that Ocean should sort them out.*

As for our review - we don't see our role in such circumstances as being to check that every little thing in the manual is accurate, it is to check that the game plays well and that all the important features work properly. On our review copy the game came up to scratch on all counts. Maybe you have one of the early bugged copies - contact Ocean and ask for a replacement copy.

### It Doesn't CLick

Why has the Amiga got such an awkward CLI? In your stand-alone Notepad you corrected the bit with the exclamation marks, and you said to repalce them with vertical bar symbols; where on the keyboard are they? I've tried backslashes and the other one the other way and even none at all, but all it does when I press return is whizz the disk round and say something about object of the wrong type.

**Phillips Dickens**  
Raunds, Northants

*At the top right of the keyboard, just to the left of the backspace key, is a key with the symbol \ on it. This key also has a broken vertical line on it, the one you need.*

### High Price of Piracy

In recent issues you have published letters which try to justify piracy of software because of high prices. Having been involved in buying business PC software, where prices are normally in several £100s or even £1000, I find Amiga software rather cheap considering the size of the market. Software houses must make a reasonable profit to finance new developments, so the pirates are putting at risk the whole home computer market.

As the Amiga is such a powerful machine it would seem a pity if honest users were denied new and innovative software by the thoughtless actions of others.

Regarding the differential in prices between the US and the UK, one element is the retailers' mark-up. In this country retailers expect a larger profit; look at the mail-order houses if your funds are tight, this month's Number One is often on cheap offer in a few weeks.

One other point, have you considered the potential harm to family budgets of the appetising reviews of hardware like the 20 card (ideal for fractals?) and programs like Digi-View IV? Children could starve if you don't stop, mine included!

**Chris Eele**  
Lychpit, Hampshire

### Airport Accident!

I bought an Amiga 500 just before Christmas because I wanted a machine that would do all my word procesing and other serious work as well as provide endless hours of amusement for our two sons; I must admit that it has done the trick on both counts.

I discovered *Amiga Format* (Issue 6) quite by accident at Newcastle Airport waiting for a

plane back to London. I saw this magazine with a disk on the front and I have never looked back.

I have been particularly impressed recently with the "Which" style reports on business software. It is very useful to be able to directly compare products in this way and I hope you will continue with similar reports on other types of software and hardware.

I have also been following with interest the correspondence on software protection and piracy. I suppose that I have some sort of vested interest in this topic because the company that pays my salary sells large, mainframe, business software packages.

Having worked in the computer industry for over 20 years now I find it an anathema to have to mount original media on any device except for the express purpose of taking security copies. It is particularly annoying as far as my Amiga is concerned because after spending a lot of hard-earned money on a hard disk it spends half of its time idle as most games cannot be copied onto it. In fact, I wrote to one well-known games software house about a program which I was able to copy onto the hard disk and they said that there was no way they were going to change this policy as there was not the market for it.

I am dead against software piracy in all its forms, but I am convinced that if the software industry showed half the wit and ingenuity of the hackers and the pirates then a solution that covered both protection and the ability to make working copies could easily be designed.

To change the subject to one which is rather less emotive, I decided to index both your game reviews and Gamebusters on my personal database. After spending several hours on this, the thought occured to me that most databases will accept data form comma-delimited ASCII text files. It further occured to me that you have the perfect delivery mechanism for this in the shape of your cover disk. How about issuing an index on one of your Coverdisks in a format acceptable to most common databases.

One-last point: I enjoy roleplaying adventures and there have been several references in your magazine to *Dungeon Master* as being the best of this genre. I do not know if you have reviewed it in an early issue; but, if so, what was its score summary in terms of Graphics, Sound, Intellect, Addiction and Overall % rating?

**Roy Bell**  
New Malden, Surrey

*Dungeon Master is available for 1 Meg machines only and, although AF has never reviewed it, we reckon it deserves these ratings now:*

Graphics	8
Sound	4
Intellect	8
Addiction	9
Overall	92%

### Mad as a Balloon

I am writing this with my foot as the people in the institution won't let me take the straitjacket off - rotters!!

Firstly, I would like to say what a brilliant game *Blood Money* is. After a year I finally completed it the other day, yet still have urges to 'have another go'. Well done Dave Jones!

Now I would like to thank Sam Cadby (AF 11) for his tips on using my funny kettle - I followed them closely and had a steaming cup of tea in no time! I think the anti-static wristbands made all the difference. I think that the Amiga makes a wonderful cheese-grater as well, and wouldn't make a sandwich without it.

Finally, I have a wonderful idea that would improve your magazine greatly. Since I took up cookery I found the flat thing on the cover of your magazine to be absolutely rubbish at making Angel Delight. I am sure many other readers feel the same way and that many will have complained. If you were to change the name of it to the "CoverWHISK" and to actually include a 3.5" whisk on every cover, then your readership would greatly increase.

I must go now as my soufflé is ready.

**Karl Drinkwater**  
Stretford, Manchester

PS I attached one of those 'RAM disk' things to the front of my car but it crumpled on the first collision. Will you complain to Commodore or shall I?

*You're a very funny man Karl - keep taking the pills and writing the letters. A special prize is on its way because you've already had a T-shirt and binder a few months back - we'll find something suitably batsarse.*

### Trouble with Women

I have a serious problem with women! Why is it I can never find a woman who will accept my Amiga? Every time I find a new girlfriend she can never accept that my Amiga is the most important thing in my life, and that it deserves my utmost attention. I mean, they go too far, don't they?

# 512 K Expansion for Amiga A500

**£47.50**

- \* Real Time Clock
- \* A501 Replacement
- \* 1 Mbit DRAMS

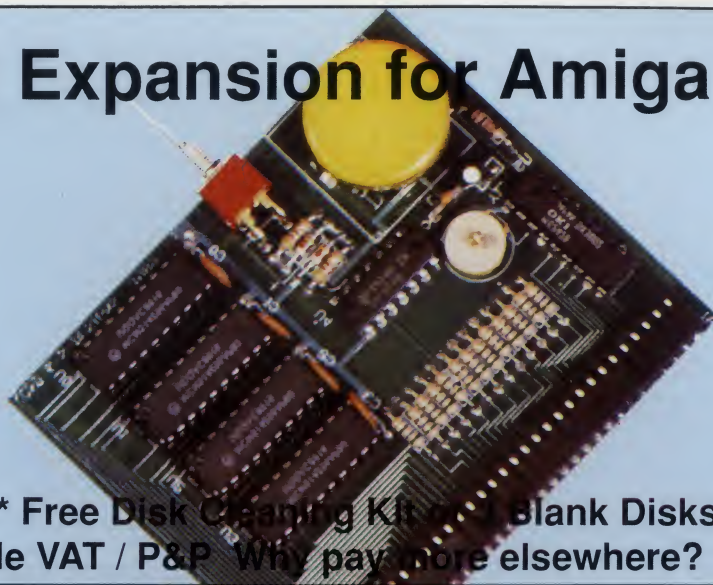

**£43.00**

- \* Memory Only
- \* Disable Switch
- \* Made in U.K.

\* Free Disk Cleaning Kit and 2 Blank Disks

**All Prices include VAT / P&P Why pay more elsewhere? Trade enquiries**

A500 3.5" Disc Drive £68 \* A500 2 Meg Expansion £285 \* A500 Dustcover £3.95 \* Amiga SCART Lead £7  
 A590 Upgrades per 0.5 meg £35 \* Mouse Mat £3.95 \* Kickstart Rom V1.3 £29 \* Disk Cleaning Kit £3.95\*  
 Summer Special Offer 3.5" Disk Drive + Board with clock £111.00  
 3.5" Disks. Quantity of 25 £12.47 (£12.47 plus £1.50 p&p)

Please send a cheque or phone your nearest distributor: 24 Hour order service available. \* Same day despatch  
**DS & K DESIGNS LTD, SPEED COMPUTER LTD**

Dept AF, Gardener's Row Business Centre  
 Gardener's Row, Liverpool, L3 6TJ  
 Tel: 051 298 1666 Fax: 051 298 2074

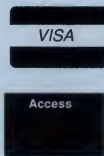

Dept AF, 41 Weymede, Byfleet,  
 Weybridge, Surrey, KT14 7DQ  
 Tel: 09323 52277 Fax: 09323 52772

## SOFTWARE MADNESS LTD THE AMIGA SPECIALISTS

### Are you fed up....?

Buying games that don't live up to their name...?  
 Want an art package but not sure which one...?

Need a database but don't understand the jargonous write ups...?

Wouldn't it be better if you could give the programmes a test run before you buy...?  
 Don't panic...!

Here at **SOFTWARE MADNESS** we run an exclusive club for Amiga owners. Now you can preview (hire) programmes before you buy.  
 Joining our exclusive club will not only allow you to preview software, it will also qualify you to make massive saving on all software and hardware alike. (Yes really...!)

Other benefits include:

News letters monthly - Access to a huge PD Library - Prices that you cannot beat - All Amiga products can be supplied - and a friendly customer service department

#### ONLY MEMBERS QUALIFY FOR FULL DISCOUNT

- ☆ All public domain & shareware = £1.50 per disk ☆
- ☆ Average preview charge on games = £3.00 ☆
- ☆ Average purchase price on games = £16.99 ☆
- ☆ Average discount "on all products" = 40% ☆

You do not have to be a member of **SOFTWARE MADNESS** to purchase any of the products listed below. The buyers guide also lists all software which is available for preview

### The Amiga users buyer guide

We at **SOFTWARE MADNESS** have compiled a complete buyers guide for the Amiga. It lists everything available for the Amiga including software - hardware and public domain software. It comes on four - five disks depending on the model of your Amiga and also includes a replacement workbench. Cost = £5.00 Inclusive.

This is something that all Amiga owners should have...!

#### Hardware

Batman Pack	£349.99
Flight of Fantasy Pack	£349.99
Class of the 90's Pack	£499.99
B2000 only	£919.99
Star LC10 Colour	£189.99
NEC External Disk Drive	£69.99
Halfmeg Ram Expansion	£49.99
Amiga 500 Work Station	£49.99

#### Software

Music X UK version	£89.99
Videoscape 3D	£69.99
Excellence	£69.99
Pro-Page 1.3	£129.99
X-Copy 2.2+Hardware	£31.99
Chase HQ	£16.99
Midwinter	£21.99
Buggy Boy	£6.99

### We are now exclusive U.K. distributor of SUPER CARD AMI - II £69.99

Copy protection gets tough....we laugh....competition gets tougher....still laughing....software manufacturers....cry !

**Super AMI - II** is the best most powerful archiving system available for Amiga computers.

**Super AMI - II** is the new version of our hardware copier **AMI - I**. **Super Card AMI - II** installs into the back of your Amiga 500/1000/2500/3000 using external disk drive. All your external drives function normally. Never making it necessary to remove the hardware unit ! Completely transparent. Amiga 2000 owners with 2 internal drives, we now have the version you need, **Super Card AMI - 2000** ! The hardware unit installs internally and is completely transparent.

**Super Card AMI-II** also has a verify option, eliminating the need to recopy disks over and over. **Super Card AMI - II** will copy all 3.5 software made....including (but not limited to) Atari ST, Apple Mac, IBM, and of course Amiga 100% guaranteed ! No exceptions...it really works.

Don't be led astray by other products that alter drive speed and clock rates, or by "Digital Image Copiers" **Super Card AMI** works because of an amazing new process called "Dupliflux" (patent pending) Which actually reads the magnetic fluctuation from the source drive and duplicating it on the destination drive...! Which means fast reliable copies every time !

Lets face it, disk copying times very from disk to disk. oddly formatted disks take longer than others, **Super Card AMI - II** uses highly advanced routines to obtain the quickest reliable copy possible. Amiga Dos disks can be copied in as little as 37 seconds, but average is about 45 seconds.

The response has been overwhelming with our original **Super Card AMI**. Here are a few letters we received from our customers.

C.I.A. User Group....**Super Card AMI** does it all ! We tried every known publisher ! Tested 4 different external drive manufacturers ! This is the best copier any of our members ever experienced ! Our Amiga, Atari and IBM users wish to thank you !!!

While it is true that our product costs more than that of our competitors, the extra spent will be well worth it. We welcome you to compare our customer support, service and copying ability with that of our competitors. We know that we rank No. 1 in all respects

With every **Super Card AMI - II** order received by July 15th you will receive NIB V2.0 absolutely FREE ! Retail value: £22.99

NIB V2.0 The most popular American shareware copier joins the commercial market. NIB will backup most commercial software made today. Ease of use and reliability are the strong points of NIB. NIB will actually by-pass "documentation" style copy protection making you backup protection FREE ! So if your tired of thumbing through pages of documentation and losing your original disks, get the most popular copier on the American market. NIB

FOR MORE INFORMATION CONTACT STEVE ON LUTON: (0582) 483640  
 OR ALTERNATIVELY WRITE TO  
 18 BUTLIN ROAD, LUTON, BEDS. LU1 1LD

# Greater London Computers

## Hardware

AMIGA 500 BATMAN PACK £389.95  
 AMIGA 500 Flights of Fantasy Pack £389.95  
 AMIGA 500 Class of the 90's Pack £559.95

## Monitors:

A1084S Stereo Colour Monitor £249.95  
 Phillips CM8833 Colour Monitor £299.95  
 Phillips BM7502 (Amber) £92.95

## Disk Drives:

A1011 External 3.5" Disk Drive £99.95  
 A590 20Mb Hard Disk £379.95  
 RAM Chips for A590 per half Megabyte £34.95

## Printers:

MPS 1230 Printer £199.95  
 MPS 1550 Colour Printer £239.95  
 Star LC-10 £199.95  
 Star LC-10 Colour £249.95  
 Star LC-24/10 £249.95

## Others:

A501 memory upgrade £89.95  
 A1352 Mouse £34.95  
 Mini Gen Genlock £129.95  
 Quickshot Turbo Joystick £9.95  
 Navigator Joystick £14.95

## Software:

Deluxe Paint III, Deluxe Video III, Publishers Choice, Pagesetter II in stock. Plus lots of Games, ring for details.

481 Hale End Road,  
 Highams Park,  
 Chingford,  
 London.

E4 9PT  
 Tel: 081-527-0405  
 Fax: 081-503-2341

## Delivery:

All orders include free delivery. Orders over £400 include free delivery by DATAPOST.

## Plugs:

All computers come with a correctly fused plug fitted.

## Mail Order:

Orders can be made by Telephone, Fax or Post. Credit card orders are checked and despatched at once. Cheques are cleared and goods despatched upon clearance.

## Other items:

Greater London Computers also stock the Amstrad PC range, Atari ST and several other systems plus printers by Epson, Star, Brother etc. We also keep a wide range of Printer ribbons and blank discs in stock at very competitive rates. Please call for details:

**Special Offer**  
 DigiView Gold V4.0 &  
 Camera &  
 Stand & Lights  
 only £405.95



Software for serious sports enthusiasts

# POOLSWINNER II

THE ULTIMATE POOLS PREDICTION PROGRAM



- **MASSIVE DATABASE** Poolswinner is a sophisticated Pools prediction aid. It comes complete with the largest database available - 22000 matches over 10 years.
- **PREDICTS** Not just SCOREDRAWS, but NO-SCORES, ALWAYS and HOMES too. Predictions are based on many factors ... recent form, the massive database, current league standing, goal scoring rates, and draw averages (each factor is independently switchable by the user).
- **SUCCESSFUL** Select guarantee that Poolswinner performs significantly better than chance.
- **LEAGUE AND NON-LEAGUE** matches are covered.
- **FULL LEAGUE TABLES** are automatically generated as results are entered.
- **FULL PRINTER SUPPORT**
- **AUTOMATIC FIXTURE GENERATION** : Fixtures for English and Scottish League matches are generated automatically by Poolswinner's sister program FIXGEN...

## FIXGEN 1990/91

- No need to struggle for hours to get the fixture list into the computer - just type in the date, Fixgen contains the complete fixture list for the whole year's league soccer. (Published under licence from the Football League, and the Scottish Football League).

£26.50  
 Poolswinner with Fixgen.

# COURSEWINNER v3

THE PUNTERS COMPUTER PROGRAM



- The ORIGINAL, and still the BEST computer punter's aid.
- Coursewinner V3 uses all the most important form pointers (past form, speed ratings, prize money, course statistics, jockey form, trainer form etc) to give a detailed assessment of every runner's chances, not just a tip.
- Vital statistics of all British courses (Draw advantage, Top Trainers and Jockeys etc) are included in the database.
- Includes both FLAT and NATIONAL HUNT versions.
- Full Printer support

£24.00

Available for... IBM (5.25", 3.5") Amstrad CPC  
 AMIGA BBC  
 Atari ST Commodore 64/128  
 Amstrad PCW Spectrum

State TAPE or DISC  
 (Add £2.00 for Disc).

Send cheque / PO for return of post service to ...

**Selec Software** (Est. 1984)

62 Altrincham Rd, Gatley, Cheshire SK8 4DP  
 (send for full list of our software)

TEL 061-428-7425  
 phone 24 hrs



# RAMSOFT

AMIGA & ST SPECIALISTS

UNIT 1 DRAKE HOUSE  
 160 DRAKE STREET  
 ROCHDALE, LANCOS  
 OL16 1PX  
 TEL: 0706 43519

## A500 FLIGHT OF FANTASY PACK

A500-Computer, TV Modulator, P.S.U. K/S 1.3 W/B 1.3 Mouse, Extras & Tutorial Disks, all leads and manuals.

PLUS:- F29 Retailator, Rainbow Islands, DPaint II, Escape From The Planet Of Robot Monsters

**ONLY £369.00**



## A500 BAT PACK

Only £359.00

+ TEN STAR PACK

1: Amegas, 2: Art of Chess, 3: Barbarian, 4: Buggy Boy, 5: Ikari Warriors 6: Insanity Flight, 7: Mercenary Camp, 8: Terrorpods, 9: Thundercats, 10: Wizball.

**R.S. PRICE! £379.00**

**Plus Photon Paint II \* Only £389 \***

**COMMODORE 1084S £249.00**

**PHILIPS CM 8833 ! £249.00**



## PRINTERS



STAR LC 10 MONO .....ONLY £159

STAR LC 10 COLOUR.....ONLY £199

PANASONIC KXP1124 .....ONLY £259

## PRINTER RIBBONS

ALL MAKES AVAILABLE, LOW PRICE

EG: STAR LC-10 MONO £4.49.

Col - £7.50

ALL OUR PRINTER PRICES ARE INCLUSIVE OF LEADS

RAM Expansion, inc. Clock & Switch...£69.95...\*.3.5" External Drive...£75.00

TDK 3.5" Disks X10...£12.00...\*.Posso 150 Cap Disk Box...£18.00

LC10 Dust Cover...£8.50...\*.Monitor Cover...£9.50...\*.A500 Cover...£7.00

Please Call for prices on items not listed

ACCESS  
 VISA  
 &  
 STYLE

Please note, all our prices include VAT & Courier Delivery. All hardware items despatched within 48 hrs, dependent on availability & cheque clearance, prices subject to change without prior notice at any time. Personal callers welcome. We are open from 09.00-17.30 Monday to Sat. E & OE.



# RAMSOFTS BOOK SHOP

\*\*\*\*\*

Amiga DOS Quick Reference (Abacus).....	£9.95
Motorola 68000 Programmers Ref Man (Motorola) .....	£9.95
Amiga Desktop Video Guide (Abacus)...NEW! .....	£16.95
Amiga for Beginners (Abacus) .....	£12.95
Kids and the Amiga (Compute!) .....	£14.95
Elementary Amiga BASIC (Compute!) (D) .....	£14.95
Amiga Machine Language (Abacus) (D) .....	£12.95
Amiga Programmers Guide (Compute!) .....	£14.95
Amiga DOS Reference Guide (Compute!) .....	£14.95
Amiga Tricks and Tips (Abacus) (D) .....	£14.95
Inside Amiga Graphics (Compute!) (D) .....	£14.95
Amiga C for Beginners (Abacus) (D) .....	£14.95
Amiga Applications (Compute!) (D) .....	£14.95
First Book of the Amiga (Compute!) (D) .....	£14.95
Amiga DOS - Inside & Out (Abacus) (D) .....	£16.95
Advanced Amiga BASIC (Compute!) (D) .....	£16.95
Computer Viruses - A High Tech Disease (Abacus - NEW!) .....	£16.95
Amiga Users Guide to Graphics, Sound, Telecom (Bantam) .....	£16.95
Amiga 3D Graphics Programming in BASIC (Abacus - NEW!) (D) .....	£17.95
Amiga Machine Lang Programming Guide (Compute!) (D) .....	£17.95
Using Deluxe Paint II (Compute!) .....	£17.95
Learning C - Graphics on Amiga & Atari ST (Compute!) (D) .....	£17.95
Amiga BASIC - Inside & Out (Abacus) (D) .....	£18.95
Amiga Microsoft BASIC Programmers Guide (Scott-Foreman) .....	£18.95
Inside the Amiga with C (Sams) Special Offer! .....	£10.00
Amiga DOS Manual (Bantam) .....	£22.95
Programming the 68000 (Sybex) .....	£22.95
Amiga Disk Drives - Inside & Out (Abacus) (D) .....	£24.95
Programmers Guide to the Amiga (Sybex) .....	£24.95
Amiga Programmers Handbook (Sybex) .....	£24.95
Amiga Programmers Handbook, Vol 2 (Sybex) .....	£24.95
Amiga Hardware Reference Manual:- A/W...NEW* .....	£21.95
Amiga ROM Kerne .....	£29.95
I Reference Manual. Libs/Devs. A/W...NEW* .....	£29.95
Amiga ROM Kernel Ref. Man.: Includes & Autodocs (A.W. NEW!) .....	£29.95
Amiga C for Advanced Programmers (Abacus - NEW!) .....	£29.95
Amiga System Programmers Guide (Abacus) (D) .....	£29.95

Books Marked (D) have a Disk Available, £9.95...Disk may be purchased separately.

Addison/Wesley Special:- Set of Technical Reference Manuals Only £70.00..\*

\*\*\*\*\* RAMSOFT EXTRAS \*\*\*\*\*

## SOFTWARE SPECIALS

Singes Castle - £32.00. \*\*Photon Paint 2 - £25.00\*\* Black Magic:-£9.99  
 We will give up to 50% Discount on most items of software. Items not in stock are available next day, subject to release schedule.

\*\*\* Please ring for price on other titles.. All prices are inclusive of postage

**AMIGA SOFTWARE SALE CHEAPEST PRICES AROUND!**



# WAXRIDE LTD



★ THESE PRICES ARE MAIL ORDER ONLY

**SOFTWARE HOTLINE 081-9039511**

**FAX HOTLINE 081-9000235**

WE ALSO STOCK SOFTWARE AND HARDWARE FOR THE - AMIGA, IBM, PC, SEGA, C64, SPECTRUM, AMSTRAD, BBC, ELECTRON.

## Special Offer Of The Month OVER 500 TITLES Available

Resolution 101 .....	£17.95	Kennedy Approach .....	£17.49
Football Manager World Cup .....	£14.95	Microprose Soccer .....	£17.49
Turrican .....	£17.95	Mr Heli .....	£17.49
Their Finest Hour .....	£21.99	Nightdawn .....	£17.49
Buggy Boy .....	£9.99	Nitro Boost .....	£4.99
Italy 1990 .....	£18.75	Ooze .....	£17.49
F-29 Retaliator .....	£17.95	Operation Neptune .....	£17.49
Thundercats .....	£9.99	Personal Nightmare .....	£20.99
Sir Fred .....	£20.99	Rock Star Ate My Hamster .....	£4.99
Champions of Krynn .....	£22.95	RVF Honda Simulator .....	£17.49
Ivanhoe .....	£17.95	SAS Combat Simulator .....	£4.99
Dragon's Breath .....	£22.95	Sideshow .....	£17.49
Rainbow Islands .....	£17.95	Sidewinder .....	£4.99
Ghosts 'n' Goblins .....	£14.95	Skweek .....	£13.99
Action Amiga .....	£20.99	Starcay .....	£9.95
Beach Volley .....	£17.49	Super Scramble .....	£13.99
Beam .....	£17.49	Tom & Jerry .....	£17.49
Blasteroids .....	£17.49	Treasure Island .....	£4.99
Blood Money .....	£17.45	Vindicators .....	£13.99
Dragon's Breath .....	£20.99	Voyager .....	£17.49
Funschool 2 2-8 .....	£13.95	Wanderer 3D .....	£13.99
Funschool 2 2-6 .....	£13.95		
Funschool 2 6-8 .....	£13.95		
Gemini Wing .....	£13.99		
Gettysburg .....	£20.99		
Hard Drivin' .....	£13.99		
Hawkeye .....	£13.99		
Infestation .....	£17.49		

### PRINTERS

Star LC-10 .....	£159.00
Star LC-10 Colour .....	£209.00
Star LC 24/10 .....	£247.00
Panasonic KXP1124 .....	£247.00
Panasonic 1180 .....	£178.00

### AMIGA HARDWARE

Class Of The 90's .....	£524.99
A500 Batman Pack .....	£379.00
Flight Of Fantasy .....	£379.00
10 Games With Computer .....	£20.00
512K RAM .....	£75.00
2nd Drive .....	£86.25

### MONITORS

Philips 8833 .....	£249.00
Commodore 1084S .....	£239.00

### DISKS

Unbranded .....	£0.60
JVC 10 .....	£6.50

### COMMODORE 64

Light Fantastic .....	£149.00
-----------------------	---------

**2 FREE BLANK DISKS ARE GIVEN WITH PURCHASES OF 2 GAMES OR MORE.**

**MANY MORE GAMES IN STOCK NOT LISTED, PLEASE PHONE FOR DETAILS.**

order mail order mail order mail order

mail order mail order mail order

**WAXRIDE LTD. Wembley Computer Centre, 542 High Road, Wembley, MIDDX, HA0 2AA**

Cheques or Postal Orders payable to WAXRIDE LTD.  
 Post and Packing FREE in U.K. Overseas £1.50 per item.  
 Subject to availability and price change without notice.  
 Goods despatched on day of order. These prices are Mail Order only.

**DON'T DELAY! RING TODAY! WHILE STOCKS LAST!**

TEL: LEEDS (0532) 637988

# FIRST CHOICE COMPUTERS

UNIT 8, ARMLEY PARK COURT, STANNINGLEY ROAD, LEEDS LS12 2AE

ALL PRICES INCLUDE VAT & DELIVERY. ALL OUR PRODUCTS ARE UK SPECIFICATION

**NEW** **AMIGA 2.3 meg**  
 Expand your system with this fast easily installed 1.8 meg board  
**ONLY £209**

**IN STOCK NOW!!** **AMIGA FLIGHT FANTASY PACK**  
 Inc. F-29 Retaliator/1 Rainbow Islands, Escape from the Planet of the Robot Monster, Deluxe Paint 2, Mouse Modulator. Add £25.00 for Batman + F-18 Interceptor, New Zealand Story Add £20.00 for 10 Star Pack. **£369.00**

**PHILIPS CM8833**  
 Stereo monitor inc lead **£249.00**  
**Commodore 1084S**  
 Stereo Monitor inc Lead **£239.00**

**NEW LOW PRICE** **AMIGA 1 MEG**  
 Memory Expansion inc real time clock. **PHOTON PAINT 2 ONLY** £15.00 when you buy 1 Meg Ram Expansion **£54.99**

**PRINTERS (inc lead)**  
 Star LC10 mono 9 pin ..... £159.00  
 Star LC10 MK II ..... £184.00  
 Star LC10 Col ..... £209.00  
 Citizen Swift 24 pin ..... £299.99  
 Colour option for Swift ..... £34.99  
 NEC P2+ 24 Pin ..... £299.00

**ACCESSORIES**  
 Naksha Mouse ..... £35.99  
 Scart Leads ..... £9.99  
 Printer Leads ..... £5.99  
 100 Capacity lockable 3.5 disk boxes ..... £7.99  
 Barx stackable disk boxes ..... £11.99  
 50 Capacity lockable 3.5 disk boxes ..... £5.99  
 Amiga dust covers ..... £4.99  
 Star LC10 cover ..... £4.99  
 14 inch monitor cover ..... £6.99  
 12 inch monitor cover ..... £5.99  
 Universal printer stand ..... £9.99  
 Mouse pads ..... £4.99  
 Mouse holder ..... £1.99  
 14" tilt and swivel monitor stand ..... £15.99  
 Midi Interface ..... £24.99

**DISCOUNT SOFTWARE**  
 Deluxe Paint 2 ..... £14.99  
 Photon Paint 2 ..... £24.99  
 Fantavision ..... £19.99  
 Comic Setter ..... £19.99  
 Kind Words V2 ..... £38.99  
 Protex WP ..... £74.99  
 Publishers Choice DTP ..... £74.99  
 Mavis Beacon Typing ..... £24.99  
 Devpac 2 ..... £49.99  
 GFA Basic Interpreter ..... £39.99  
 Mastersound ..... £34.99  
 Deluxe Video III ..... £64.99  
 Aegis Video Titrer ..... £89.99  
 Penpal ..... £99.00  
 Prodata ..... £69.99  
 Amos Creator ..... £43.99  
 Home Accounts ..... £24.99  
 Aegis Graphics Starter Pack 4 titles ..... £29.99  
 Music X ..... £119.99

**DISKS**  
**100% ERROR FREE LIFETIME GUARANTEE 135 TPI 3.5 INCH**  
**SONY BULK**  
 10 ..... For ..... £6.99  
 50 ..... For ..... £31.99  
 100 ..... For ..... £59.99  
 200 ..... For ..... £115.99  
 300 ..... For ..... £158.99  
 500 ..... For ..... £254.99  
 1000 ..... For ..... £499.99  
**MITSUBISHI BULK**  
 10 ..... For ..... £5.99  
 50 ..... For ..... £27.99  
 100 ..... For ..... £49.99  
 200 ..... For ..... £97.99  
 300 ..... For ..... £142.99  
 500 ..... For ..... £229.99  
 1000 ..... For ..... £449.99  
**DISK LABELS**  
 500 ..... For ..... £7.99  
 1000 ..... For ..... £13.99

**DISK AND HARD DRIVES**  
 Star LC24/10 24 pin mono ..... £249.00  
 Cumana Amiga 3.5 1 Meg ..... £74.99  
 Amdrive 30 Meg Hard Drive ..... £389.00  
 Amdrive 50 Meg Hard Drive ..... £459.00  
 Com A590 20 Meg Hard Drive ..... £369.00  
 Com A590 inc 2 meg populated board ..... £479.00

**AMIGA BOOKS AT DISCOUNT PRICES**  
 Amiga Hardware Ref. .... £21.49  
 Amiga Basic Inside & Out ..... £17.99  
 Amiga Tricks & Tips ..... £14.49  
 Amiga C For Beginners ..... £17.99  
 Amiga Machine Language ..... £14.49  
 Second Book Of Amiga ..... £16.49  
 Amiga Dos Reference Guide ..... £14.99  
 First Book of Amiga ..... £16.49  
**THIS IS ONLY A SMALL SELECTION**

**COMPUTERS**  
 Amiga Batpack inc Deluxe Paint 2, Batman, F18 Interceptor, New Zealand Story, Mouse, Modulator and manuals. **£369.00**  
 Amiga Batpack plus 10 Star games pack **£389.00**  
 Amiga A500 inc mouse, modulator, manuals **£349.00**

**OPEN 9.00AM TO 5.30PM MONDAY TO SATURDAY OPEN SUNDAYS 10.00AM TO 3.00PM .OPEN THURSDAY 'TILL 8PM FOR THE BEST PRICES, BEST ADVICE AND THE BEST SERVICE, YOUR ONLY CHOICE IS FIRST CHOICE. Call into our showroom or order by telephone for a fast delivery Tel: 0532 637988 Fax: 0532 637 689 Please make cheques payable to First Choice**

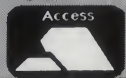
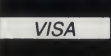



# PHOTOFILE

## ST & Amiga Digitising Service

Not only do we digitise your pictures (up to A4 size) in any Amiga format or resolution, we send your pictures back to you as an auto-booting slideshow!  
Over 1000 satisfied customers - including Psygnosis (Shadow of the Beast) and RGB Studios (Real Things).

# CLIP ART

Almost 2000 mono IFF line art pictures on 7 disks! Ideal for DTP, Deluxe Paint, Photon Paint, Pen Friend, animations etc.  
Hundreds of subjects covered! Available only from Photofile for just £35.00



Digitising costs - £1.75 per colour picture and £1.25 per b&w, picture, HAM, Halfbrite, Lo-res, High-res. Interlace or Overscan if required.

Please add £3.00 per order for setup, Kodak disk and P&P.  
Send £3.00 for our demo disk of digitised images or an SAE for our advice and information sheet.  
Please make cheques/P.O.s payable to Photofile, PO Box 49, North PDO, Nottingham, NG5 6SR  
Phone (0602) 261498 for enquiries or Access/Visa orders.

Graphics House, Styles Road, Arnold, Nottingham NG5 6RE

# REPAIRS

FULLY QUALIFIED ENGINEERS ON SITE TO UNDERTAKE REPAIRS OF, **COMPUTERS, DISC-DRIVES, PRINTERS AND MONITORS.**

ALL WORK GUARANTEED FOR **3 MONTHS. FREE ESTIMATES.**  
Tel: **MARK OR MARTIN (0527 85) 3374**  
**BUSINESS HOURS Mon-Sat 9am to 8pm**

## AMPOWER COMPUTER REPAIRS

15a ALCESTER ROAD, STUDLEY, WARCS B80 7AG

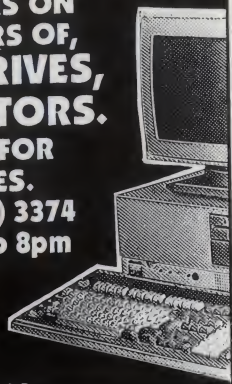

## AMIGA PUBLIC DOMAIN SOFTWARE LIBRARY

- \* No subscription fee \* Free catalogue on request \*
- \* Monthly bulletins containing news, offers, competitions etc \*
- \* Wide range of disks rapidly growing \*
- \* All our disks are virus free \*
- \* All disks cost £2.00 each ten or more £1.50 each \*
- \* Immediate despatch on all orders \*
- \* Full range of commercial software \*
- \* 10 3.5" unbranded Sony DS/DD disks £7.50 \*

FREE.....with your first order of ten or more disks you will obtain a disk full of virus killers....!

Send SAE for details.  
Or send £1.50 for catalogue disk

WCA Business Systems  
250 Carmarthen Road,  
Swansea.  
SA1 1HG.  
Tel: (0792) 473550.



## MISTRAL COMPUTER SUPPLIES



0705 453814



### AMIGA SOFTWARE

F29 Retaliator.....	16.99	F.O.F.T.....	13.99
Swords of Aragon.....	19.99	After The War.....	13.99
Fire & Brimston.....	16.99	Ivanhoe.....	16.99
Ghosts & Goblins (1 meg).....	16.99	War Head.....	16.99
Heros Quest (1 meg).....	24.99	Sim City.....	19.99
Space Ace.....	29.99	Escape From Singes Castle.....	29.99
Their Finest Hour.....	19.99	Xenomorgh.....	16.99
World Cup Football Manager.....	16.99	Fire Brigade.....	19.99
Italy '90.....	16.99	Cross Bow.....	13.99
Turrican.....	13.99	Full Metal Planet.....	13.99
Resolution 101.....	16.99	Italia 90.....	13.99
Shadow Of The Beast With T-Shirt.....	24.99	Colorado.....	16.99
Man United.....	16.99	Leisure Sult Larry III.....	29.99
Cyberball.....	13.99		
Emlyn Hughes.....	13.99		
Dytir 07.....	13.99		
E.F.T.P.O.R.N.....	13.99		
Dragons Breath.....	19.99		
Pipe Mania.....	16.99		
Klax.....	13.99		
Mile Stone.....	13.99		
Budokarn.....	16.99		
Kid Gloves.....	16.99		
Space Rogue.....	19.99		
Midwinter.....	19.99		
Tower Of Babel.....	13.99		
Super Cars.....	13.99		

### ★ BUDGET TITLES ★

Spidertronic.....	3.99
Hunter Killer.....	3.99
Grim Blood.....	3.99
Zoom.....	6.99
Buggy Boy.....	6.99
Thundercats.....	6.99
Projector.....	3.99
P47.....	10.99
Scrambled Spirits.....	10.99
Ikari Warriors.....	6.99

### ★★★★★ AMIGA HARDWARE ★★★★★

Amiga Bat Pack.....	Phone
Amiga Flight Of Fantasy.....	359.99
The above with Tenstar Games Pk.....	379.99
A590 Hard Drive 20Mb with free software.....	355.99
A501 RAM Exp with Dungeon Master.....	89.99
Trapper RAM with It Came From The Desert.....	79.99
Cumana External Drive.....	79.99
1084S Colour Monitor.....	247.99
Amiga Control Centres.....	29.99
Sony Unbranded 3.5 disks 10.....	65p each
50+.....	60p each

Send Cheques/ PO to **Mistral Computer Supplies, 42 Park Way, Havant, Hants PO9 1HH**

Please add £5 per item of Hardware to cover 1st class postage; Software add 50p per game. Send for full Software and Hardware list.

# RAMTEK

Buy direct from the Manufacturers  
Highest quality, lowest price

**A500  
1/2 MEG  
RAM  
Expansion**  
**A500  
1.5 MEG  
RAM  
Expansion**

**£52**  
INC VAT

**£149**  
INC VAT

BOTH WITH BATTERY BACKED CLOCK ON/OFF SWITCH & HIGH SPEED D.RAMS

Cheques to **RAMTEK**  
P.O. Box 94, Oldham, OL4 4SX

Tel: **061 627 2044**

24 Hr Credit Card Hotline





For example, my last girlfriend could not understand why I spent 23.5 hours of the day in front of it and in the end she even wanted me to leave my Amiga and take her out and talk to her!!!! Well, I couldn't have that so I told her to bog off!!!

I have written to tell you because you normally answer all Amiga problems. Anyhow, do you think my attitude is in any way wrong? Please let me know, because my sanity is going down the tube quite quickly Wibble...!

**Nick Margam,  
West Glamorgan**

PS I think it would be a good idea for you to review girlfriends.

*If we were to indulge in such a sexist act, the expected lifespan of those members of the AF team that have girlfriends would be about as long as it took someone to read this reply.*

### Yoga Positions

I have just read the letter titled 'Dear Mr Perfect' and quite frankly I can think of several yoga positions that I would like to put 'Anonymous' in.

I personally am an aspiring games programmer. Although my games are still weak and poorly implemented, my experience has meant that I can see the amount of effort that goes into writing a bad game. So, I shudder to think of the effort going into *Blood Money* and *Xenon II*. Can he not see the difference between a two colour sprite and a 16 colour sprite that moves across a dazzling background, with music that makes some of the house groups look at their feet?

The £24.95 price tag may not be totally justified. But who can blame software companies: they must have seen it coming with the piracy on the 8-bits although that was not as blatant and arrogant. I cannot believe that these guys can really justify what they are doing in their own minds. To rip off software is a selfish and childish occupation. I would like there to be games industry for me to work for when I finish my degree.

**Nigel Hughes  
St Albans, Herts**

### Lost his Keys

Once upon a time (May 1990), I bought an Amiga; after waiting 2 years to buy one I finally bought the Flight of Fantasy pack. I was ecstatic, overjoyed, rapturous – well, pleased anyway.

Along with the computer came some games, and some games I bought myself. But when I played these games, what happened? I

found that most of these games were either joystick or mouse controlled. NO KEYBOARD CONTROLS. I was horrified; with the exception of two games (*Phobia* and *Super Hang-On*) there were no keyboard controls. Now this may seem petty, but after owning a Spectrum 128 for 2 years I was used to playing with a keyboard and I found it easier to use, but why not on my Amiga!!!!???

Do you have any ideas? It can't be lack of memory or such like. So, please if any programmers are reading this, take note; after all, you wouldn't want me to sell my Amiga and buy a Spectrum.

**P D Mellerick  
Leicester**

*Keep checking our game reviews – if there's a keyboard option we say so in the heading.*

### I'll Modulate your Bender!

What's Jon Bates on about (Issue 11 – Music). He reckons *Sonix* does not support MIDI. Just tell him that *Sonix V2.0* can handle 16 MIDI instruments playing 32 sounds each on any one of *Sonix's* eight tracks. That's 4,096 MIDI possibilities. So there.

And if you've got no idea about music then check out your local library, get a book of scores, key in a tune and hey presto! – you can play. It's not all that difficult to create your own house music either. Check out the examples from your PD supplier.

So tell Jon to get his facts right or I'll come down there and modulate his bender.

If you've got *Sonix* and have problems with loading data disks, and if you've tried to access the 'read me' file and found it won't load, just put it through Ed to read or your favorite text editor. Because the manual doesn't tell you how to do it.

**K Scales  
Darwen, Lancs**

### High Rise

Re all the letters in the June issue regarding high price games. They all seem to refer to the software houses making the money. I recently went into a shop to buy a game, while the guy was out the back getting it my eyes happened to glance across one of his trade invoices. *Xenon II* cost him £6.95 maybe plus VAT, I couldn't see the bottom of the bill.

He and most other shops are selling it for between £15 and £18. Special Reserve are the only ones I have seen selling at £6.99. So maybe the shops ought to stop ripping us gamers off. I also agree with Tom Haslam's letter (June

issue) about shops pirating copies. This doesn't just apply to employees doing it, I've seen the boss in my local shop using copies of games. He doesn't even employ any staff.

**J Ankin  
Pennyland, Bucks**

### Pay the Money...

Like many other readers, I despise those who have no intention of ever buying an original disk, but software companies are not completely innocent.

Personally I have no objection at all to paying for quality software such as *Kick-Off*, which completely deserve their price tags. However I think it is disgusting that us law abiding customers are continually abused by lazy and greedy companies. They must realise that unoriginal game formats with jazzy graphics and sound does not qualify as "quality software".

**Mark Jarvis  
Broadstone, Dorset**

### ...or Don't!

I read with interest all these people who are complaining about the cost of games software.

There is an easy solution – don't buy it!

I've found that ever since I stopped buying all these overpriced, overhyped and overly BORING pieces of software, I am now having more fun than ever before.

Sure, applications software and the like costs more, but at least you know you really want it before you buy, and chances are that you will be still using it in a couple of months' time. Unlike games where the lasting interest spans about a week if you're lucky. So, until the software houses come up with something worth spending my hard earned money on, then they can count me out.

And if there are others out there like me, two games I can recommend are *Stunt Car Racer* and *Player Manager*.

**Tim Lloyd  
Hong Kong**

### Disk Doctor

Here is a neat tip for getting rid of any virus on any file or disk. Get the affected item and wrap it up in something warm, a scarf or bobble hat would be fine, and tell it to go to bed. Give it lots of hot drinks and check its temperature often. If needed use certain drugs, but seek medical advice from your doctor first. After several days using this treatment the affected items should be fit enough to play for Chelsea in the next FA Cup.

**John Ward  
Blackpool, Lancs**

### Computing in the Dark

In response to a question raised by Sam Cadby in Issue 11 of *Amiga Format* I decided to work out how much electricity my Amiga used on average, per hour.

The search for the answer to this took me to the underside of my Amiga power supply. Here I found moulded into the plastic, "Input 240V~50Hz 60W". So from this I deduced an Amiga uses 60 watts of electricity an hour.

However the cost of your monitor or TV also has to be taken into account, as not many people run their Amigas without a TV or monitor, you know! My 14 inch colour TV has a rating of 54 watts, making my total power consumption 114 watts per hour. At this rating I can run my Amiga and TV for 8 hours, 46 minutes and 19 seconds on one unit of Scottish Power's electricity.

This costs less than running two 60 watt light bulbs for the same amount of time! What would you rather have? Two light bulbs or an Amiga and monitor? I know what I'd prefer!

**Gavin Dickson  
Melrose, Scotland**

### On the Demo

Why don't all software companies sell a demo of their product for £2 which can be redeemed against a future purchase of the product. My argument for this is as follows.

- i) The complete program has already been written.
- ii) A demo can sell the product better than mere words can.
- iii) It would ensure more people saw the program than would otherwise buy/see it.
- iv) Perhaps a deal with magazines could be reached so a disk would reach more people quickly (cheap advertising and distribution).

**James Abram  
Albrighton, West Midlands**

### Our Reviewer, a Dipswitch?

I would like to put the record straight about an article written in Issue 11 of *Amiga Format*, the article being the write-up on the Citizen 120-D.

Whoever did the article said one of the printer's bad points is having to remove the interface cartridge to alter the DIP switch settings. I'm sure this was a deliberate mistake as you don't have to do this. If you look in the top of the unit, directly under the printer ribbon there is a little sliding door. If you slide this door to the right, guess what's underneath it... Right first time! The dip switches!

**G S Sumner  
Huntingdon, Cambs**

# GURU'S MEDITATIONS ON ENTERING THE EDINBURGH ANIMATION COMPETITION

NAME: ..... TITLE OF ENTRY: .....

TEL: ..... NAME OF COPYRIGHT HOLDER: .....

ADDRESS: ..... FORMAT OF ENTRY:

.....  3.5" FLOPPY DISK

.....  PAL VIDEOTAPE

MODEL OF AMIGA:  A500  A1000  B2000

**DETAILS OF PERIPHERALS ADDED:**

.....

**Conditions of Entry**

1. The competition is open to any Amiga user. 2. The organisers reserve the right to refuse entry. 3. No entries can be returned. 4. No prizes can be exchanged for cash. 5. Entries which fail to run for any reason whether due to defective or corrupt disks or faulty video tape will be excluded. 6. Copyright remains with the copyright holder. The copyright holder grants The Amiga Centre Scotland the right to display entries. 7. All entries must be accompanied by an official entry form. 8. All entries must be received by July 31st 1990. 9. The judges' decision is final and no correspondence will be entered into.

**PLEASE LIST ALL THE SOFTWARE USED IN THE CREATION OF YOUR ENTRY:**

.....

**HAS THE ANIMATION BEEN CREATED SOLELY ON THE AMIGA? IF NOT PLEASE GIVE DETAILS OF OTHER HARDWARE/VIDEO SYSTEMS USED:**

.....

**ANY OTHER RELEVANT INFORMATION:**

.....

I DECLARE THAT ALL THE INFORMATION I HAVE GIVEN IS ACCURATE AND AGREE TO ABIDE BY THE COMPETITION RULES.

SIGNED: ..... DATE: .....

PLEASE SEND THIS FORM OR A PHOTOCOPIED TO: AMIGA CENTRE SCOTLAND, 4 HART STREET LANE, EDINBURGH, SCOTLAND, EHI 3RN.

## ADVERTISERS' INDEX

16 Bit Centre.....158	Challenge Software.....160	Greater London	Micro-APL.....126	Selec Software.....174
17 Bit Centre.....83	Checkmate.....144	Computers.....174	Microsnips.....142	Senlac.....80
A-Z Computers.....148	Comp-u-Chat.....154	Guiding Light.....154	Microtext.....154	Seven Disk.....168
A.R.K.....163	Compumart.....85	Hammersoft.....89	Mindscape.....65	Siren Software.....69
Ace Repairs.....152	Computerwise Brighton.....99	Hampshire Micros.....124	Mirrorsoft.....8, 44	Soft Exchange.....124
Activision.....11, 43, 56	Crazy Joes.....89	Hanwoods.....22-23	Mistral Computer	Soft Machine.....118
Advantage.....154	D.S. & K. Designs.....173	Hi-Soft.....117	Supplies.....176	Softsellers Ltd.....139, 144
Alternative Image.....163	Dataplex.....165	Hobbyte.....128	MJC Supplies.....112	Software Business.....21, 30
Amfas Software Ltd.....62	Date! Electronics.....70-73	Home Based Business.....163	Music Matrix.....99	Software Madness.....173
Amiga User Group.....124	Delta Pi.....115	JTS PD.....85	NBS.....80	Software Superstore.....122
Amiganuts United.....89	Digicom.....18	Instamec.....140	New Dimension.....99	Softwise.....152
Ampower.....176	Disk Express.....141	Interface Software.....131	New Image.....80	Solid State.....160
ARB Computers.....120	Domark.....14	Intermediates.....95	Newtek.....OBC	Sovereign Software.....140
Ashcom.....165	Ealing.....140	J.D. Lewis.....163	Nortec.....108	Spectra Video.....59
Atari.....49, 53	E.M.P.D.L.....86	JTS PD.....85	Nova.....89	State of the Art.....99
Athene Consultants.....128	E.S.P. Education.....126	K&M Computers.....169	Ocean.....IFC, 3, 157	Stone Mailsoft.....146
Audiogenic.....36	Ealing.....140	Kadsoft.....85	Omni Dale Supplies.....140	T.A.M. Marketing.....120
Audition Compact	Elite Electronics.....176	Key Software.....169	On-Spec.....152	Technical Developments.....55
Services.....126	Entertainments	Ladbroke.....159	P. Dom P.D.....90	Third Coast
Beat This Amiga PD.....86	International.....74	M.D. Office Supplies.....134	P.D.Q. Software.....152	Technologies.....34-35
Belshaw Comp. Shop.....163	Eprom Services.....86	Magnetic Media.....86	Palace Software.....78	Trilogic.....93
Best Byte.....128	European Peripheral Distribution	Mandarin Software.....6, 115	Photofile.....176	TurboSoft.....132
Bitcon Devices Ltd.....110	136	Manor Court Supplies.....118	Power Computing.....149-151	UBisoft.....104
Blitterchips PD.....86	Evesham Micros.....164	Matrix Software.....168	Premier PD.....80	Unicorn Software.....144
Brighton Computer	First Choice.....175	Media Direct.....94	Proton Software.....120	US Gold.....33, 40, 101
Supplies.....165	G.T.I.....168	Megaland.....67	R.C. Simulations.....152	Virgin.....IBC
Bruce Everiss.....168	George Thompson	Memory Expansion.....133	Ramssoft.....174	W.C.A.....176
Byteback.....107	Services.....29	Merlin Computers.....115	Riverdene PDL.....89	Waxride Ltd.....175
		Merlin Express.....24	Sector 16.....89	Worldwide Software.....146



# WORLD CUP SOCCER ITALIA 90 THE ONLY OFFICIAL WORLD CUP COMPUTER GAME FOR THE 1990 CHAMPIONSHIP

ACCEPT NO  
SUBSTITUTE

### AVAILABLE ON:

IBM PC	CBM 64 DISC
AMIGA .1 MEG	SPECTRUM 48/128
AMIGA .½ MEG	SPECTRUM +3
ATARI ST	AMSTRAD CASS
CBM 64 CASS	AMSTRAD DISC

### PACK CONTENTS:

Free World Cup wall chart

*Plus*

World Cup Story 1930-1990

*Plus*

Amazing facts & figures from all championships

*Plus*

Competition to win:- weeks at the Bobby Charlton School of Football (to be coached by 1st Division Footballers). Plus a Football Strip of your own choice. Videos of the 1990 World Cup Championship. Footballs. T-Shirts.

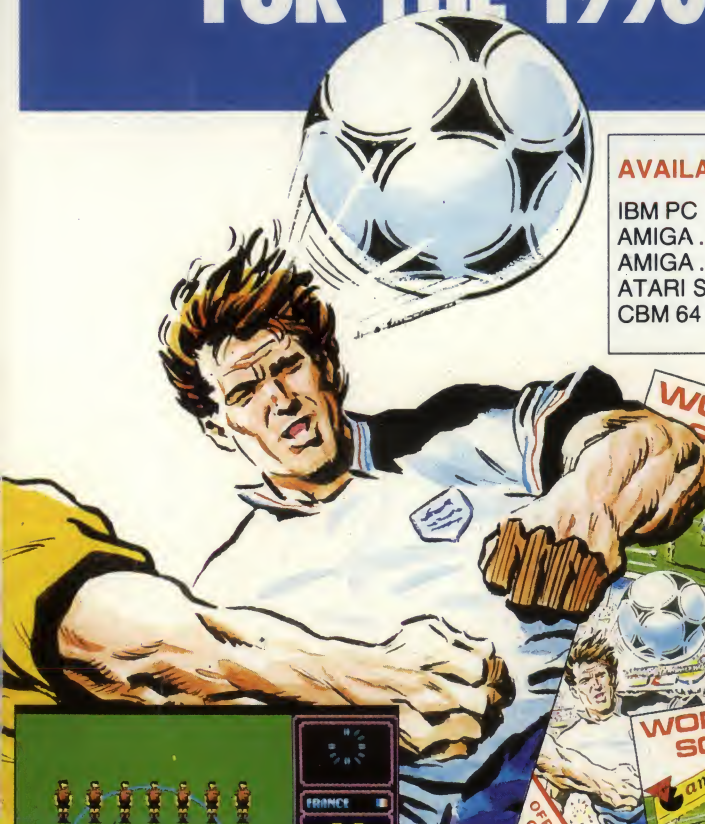

IBM



ATARI ST



AMIGA



Licensed by OLIVETTI official supplier ITALIA '90'.  
Available from W.H. Smiths, Menzies, Boots, Woolworths your local VIRGIN store and all leading software retailers.  
©1990 Virgin Mastertronic, 2-4 Vernon Yard, 119 Portobello Road, London W11 2DX.

# DIGI-VIEW GOLD

4096 Colours in High Resolution...is just the beginning



W

ith the all new Digi-View 4.0 software you can do the one thing most people thought was impossible — digitize and display all 4096 colours

in high resolution! We call this revolutionary new graphics mode Dynamic HiRes. Amiga Format magazine calls it "breathtaking, easily the best images ever seen on an Amiga screen." But that's just the start of what makes Digi-View 4.0 a breakthrough. Other new features include: Dynamic HAM (fringe free HAM), Noise Reduction (for the sharpest images ever), ARexx support, super bitmap digitizing, 24 bit colour support and dozens of other new features making Digi-View Gold the hottest Amiga graphics product ever.

And it's still just as easy to use. Simply focus your video camera on any object or picture, and in seconds Digi-View Gold turns it into Amiga graphics that glow with vibrant colour and stunning clarity. Whether you are creating graphics for desktop publishing, presentations, video, or just for fun, Digi-View Gold gives you dazzling images with amazing simplicity.

These images were photographed directly from an Amiga 1080 monitor and show the new 4096 colour Dynamic HiRes mode available only with NewTek's Digi-View 4.0

## Digi-View 4.0 and Digi-Paint 3 Become One

with the ultimate link between digitizer and paint program. With Digi-View 4.0's Digi-Port feature they can both share the same screen so that touching-up your digitized images is easier than ever. Transfer 768 x 592, 4096 colour super bitmaps from Digi-View 4.0 to Digi-Paint 3 with a simple menu command, make changes such as combining images or adding titles, and redisplay them as Dynamic HiRes or other resolution images.

## Only Digi-View Gold:

- Digitizes in all Amiga resolution modes from 320 x 256 up to 768 x 592 (full HiRes overscan)
- Includes powerful Digi-Paint 1 software for retouching digitized images or creating original artwork
- Uses 2 to 4096 colours (including halfbrite)
- Has exclusive Dynamic modes for 4096 colours in HiRes
- Digitizes in 21 bits per pixel (2.1 million colours) for the highest quality images possible
- Has advanced dithering routines that give an apparent 100,000 colours on screen simultaneously
- Has a special line art mode for desktop publishing
- Comes with an icon driven slideshow program for presentations using both IFF and Dynamic images
- Has complete software control of colour saturation, brightness, sharpness, hue, resolution, and palette
- Digitizes in full overscan with no borders for use with video genlocks
- Offers an unprecedented lifetime warranty

If you want the best graphics possible for your Amiga, then get the best selling video digitizer of all time: Digi-View Gold.

Only £149.95

Inc. VAT

For a NewTek authorized dealer near you contact HB Marketing, Ltd. at 0753 686000

Now includes  
Digi-Paint 1

**NEWTek**  
INCORPORATED

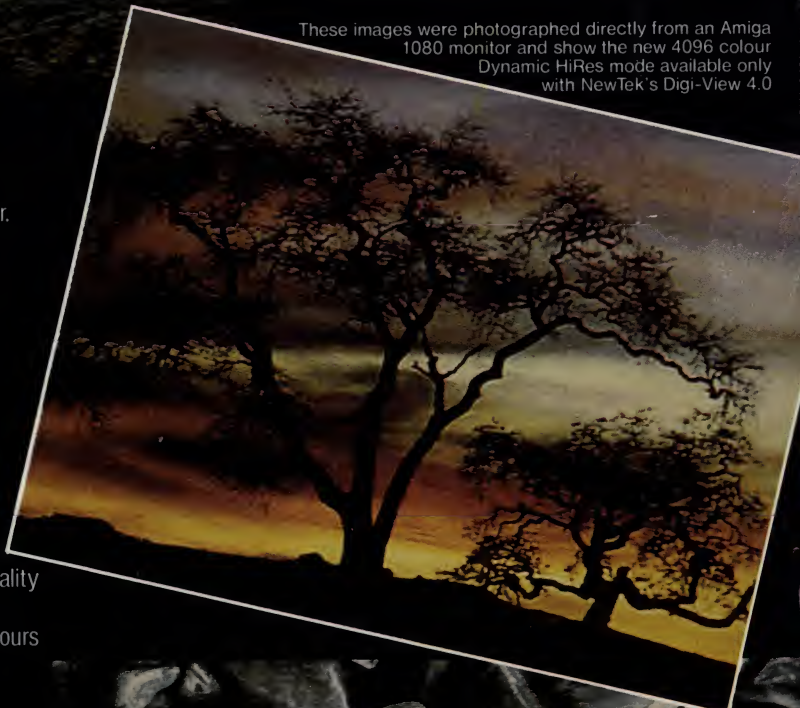

\*Requires standard gender changer for use with Amiga 1000. Dynamic HiRes requires 2 megs of RAM. Digi-View Gold is a trademark of NewTek, Inc.